



## Inter Company Correspondence

Telephone

Date

12/14/87

To — Name & Department

CIMS Number

Jeep & Truck Engineering

From — Name & Department

CIMS Number

F. J. Castaing

Subject:

Organization Charts

Attached is a complete set of organization charts for Jeep & Truck Engineering.

F. J. Castaing

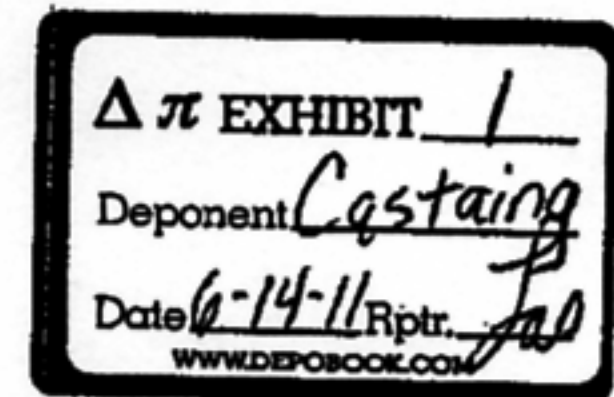

JEEP AND TRUCK ENGINEERING  
DECEMBER 14, 1987

JEEP AND TRUCK  
ENGINEERING  
VICE PRESIDENT  
F. J. CASTRANG

EXECUTIVE  
SECRETARY  
D. IRONELLI

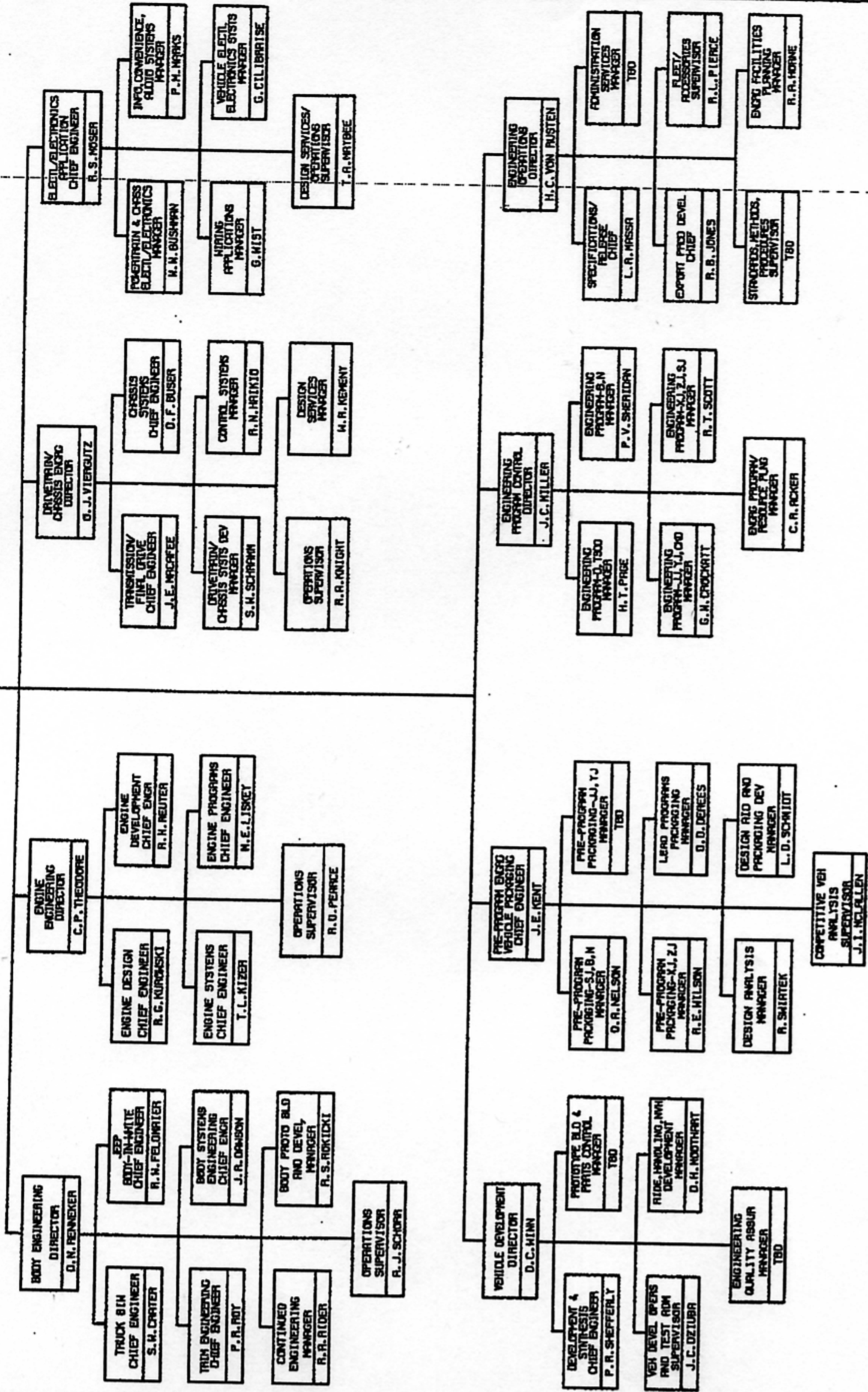

ENGINEERING PROGRAM CONTROL  
DECEMBER 14, 1987

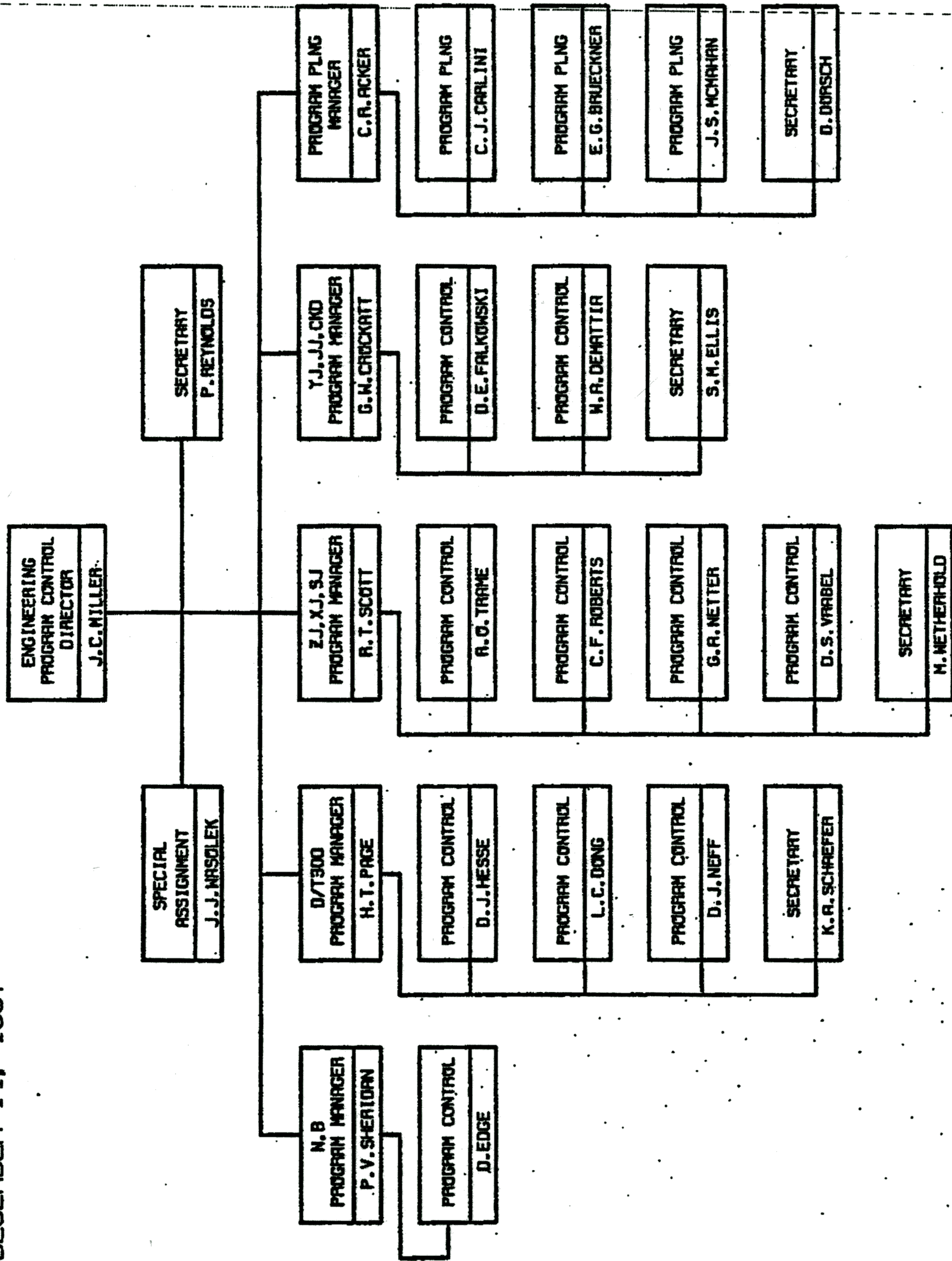

DRIVETRAIN/CHASSIS ENGINEERING  
DECEMBER 14, 1987

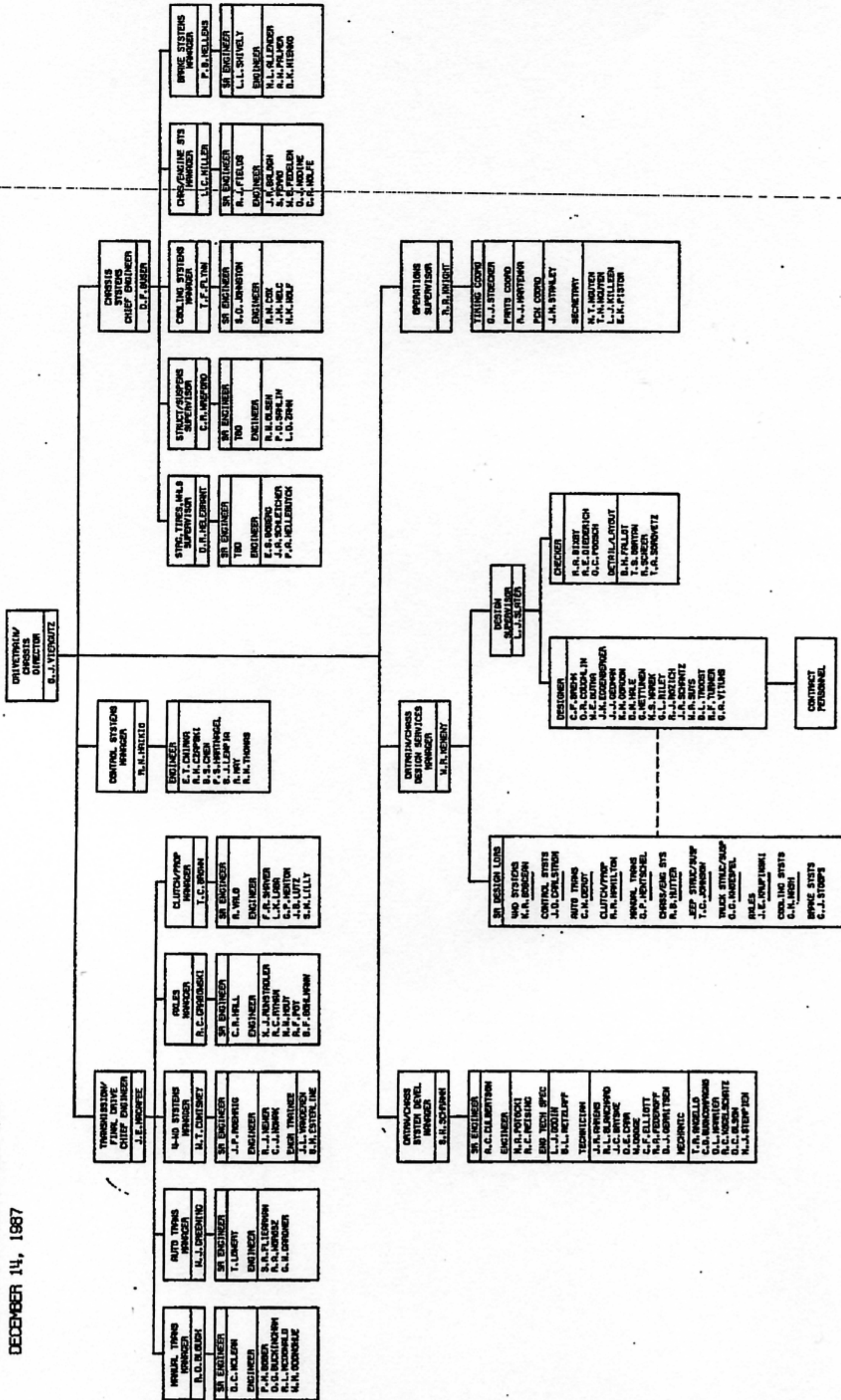

**BODY ENGINEERING**  
**DECEMBER 14, 1987**

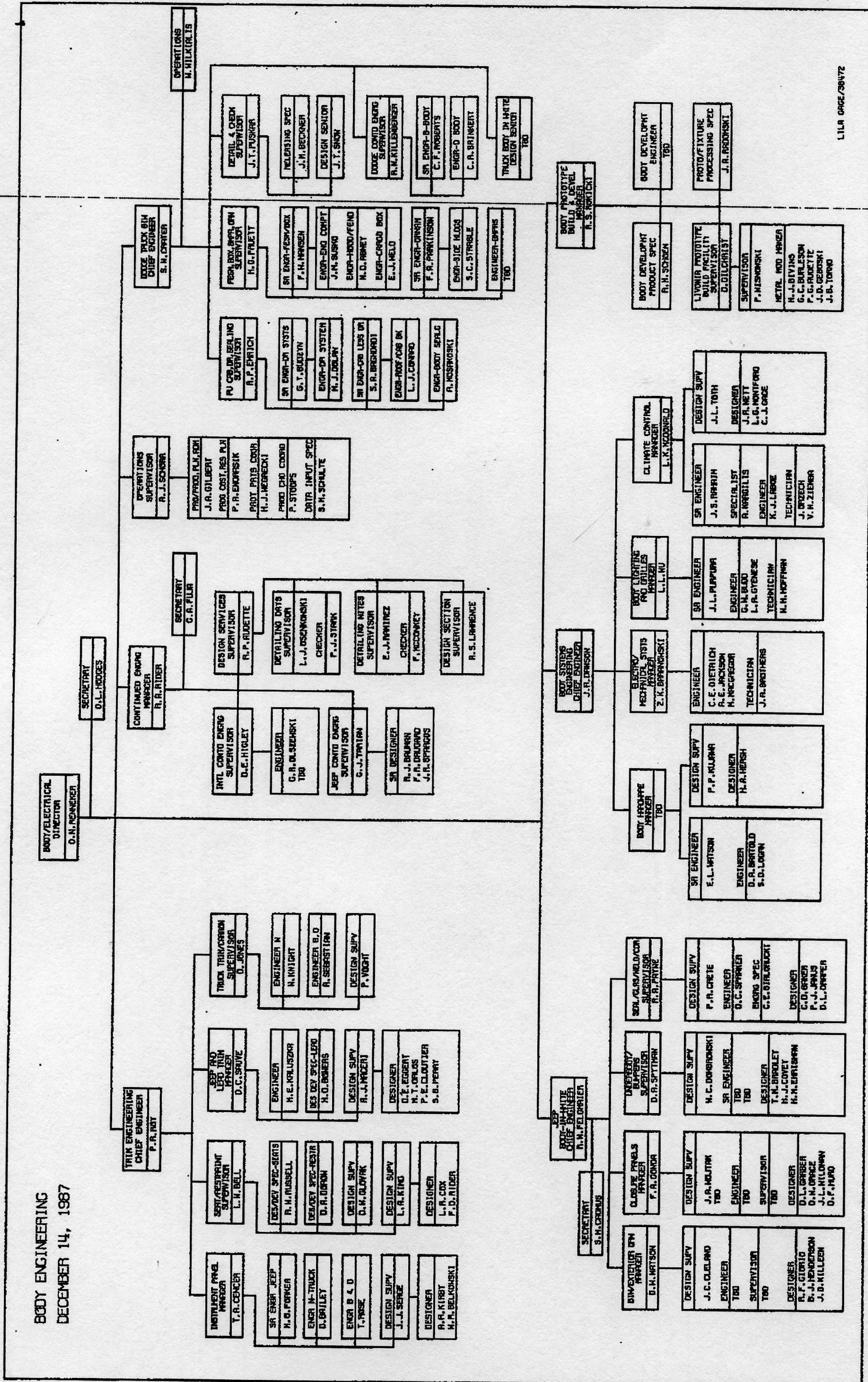

L118 GRCE/38V72

ELECTRICAL/ELECTRONICS

DECEMBER 14, 1987

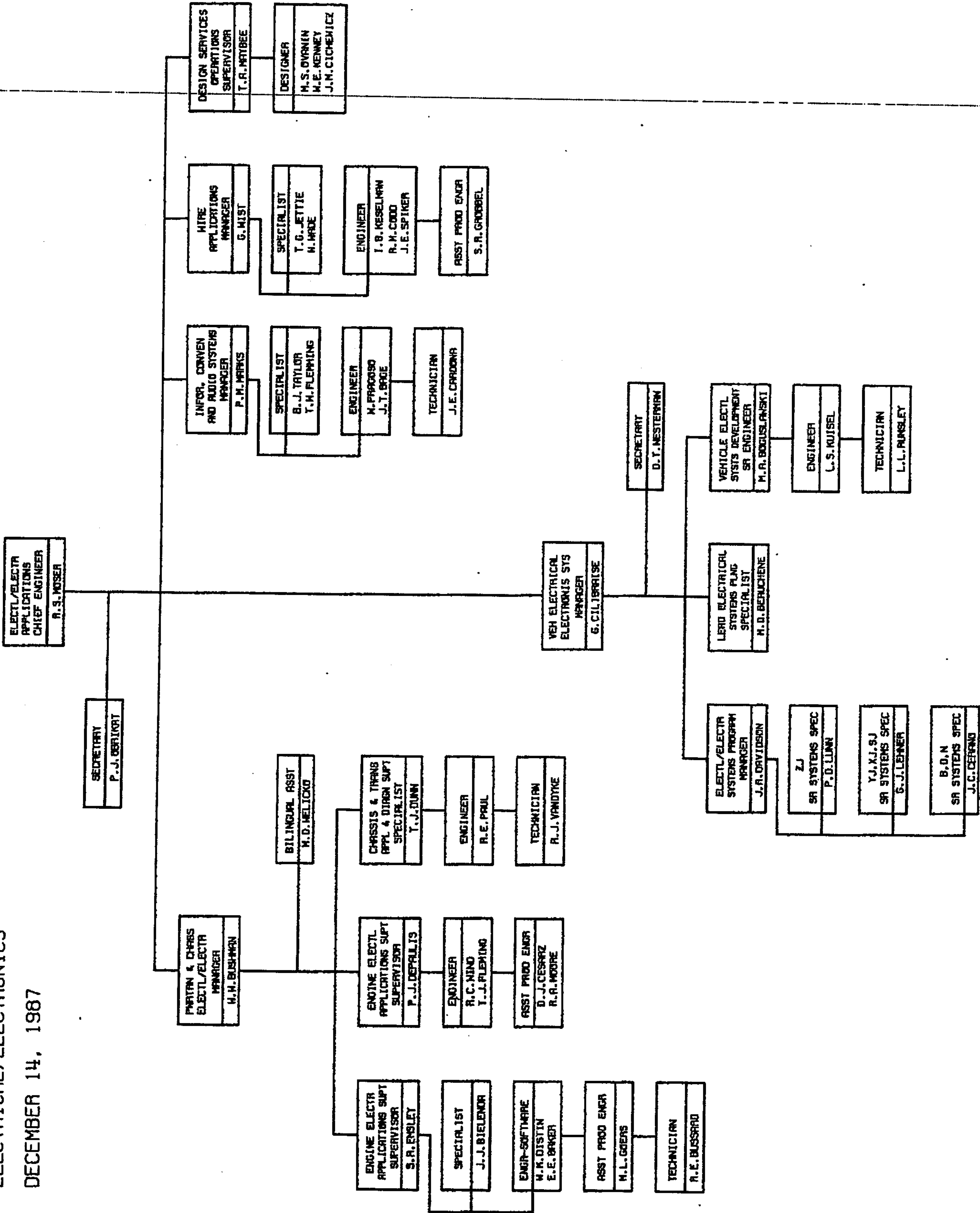

VEHICLE DEVELOPMENT  
DECEMBER 14, 1987

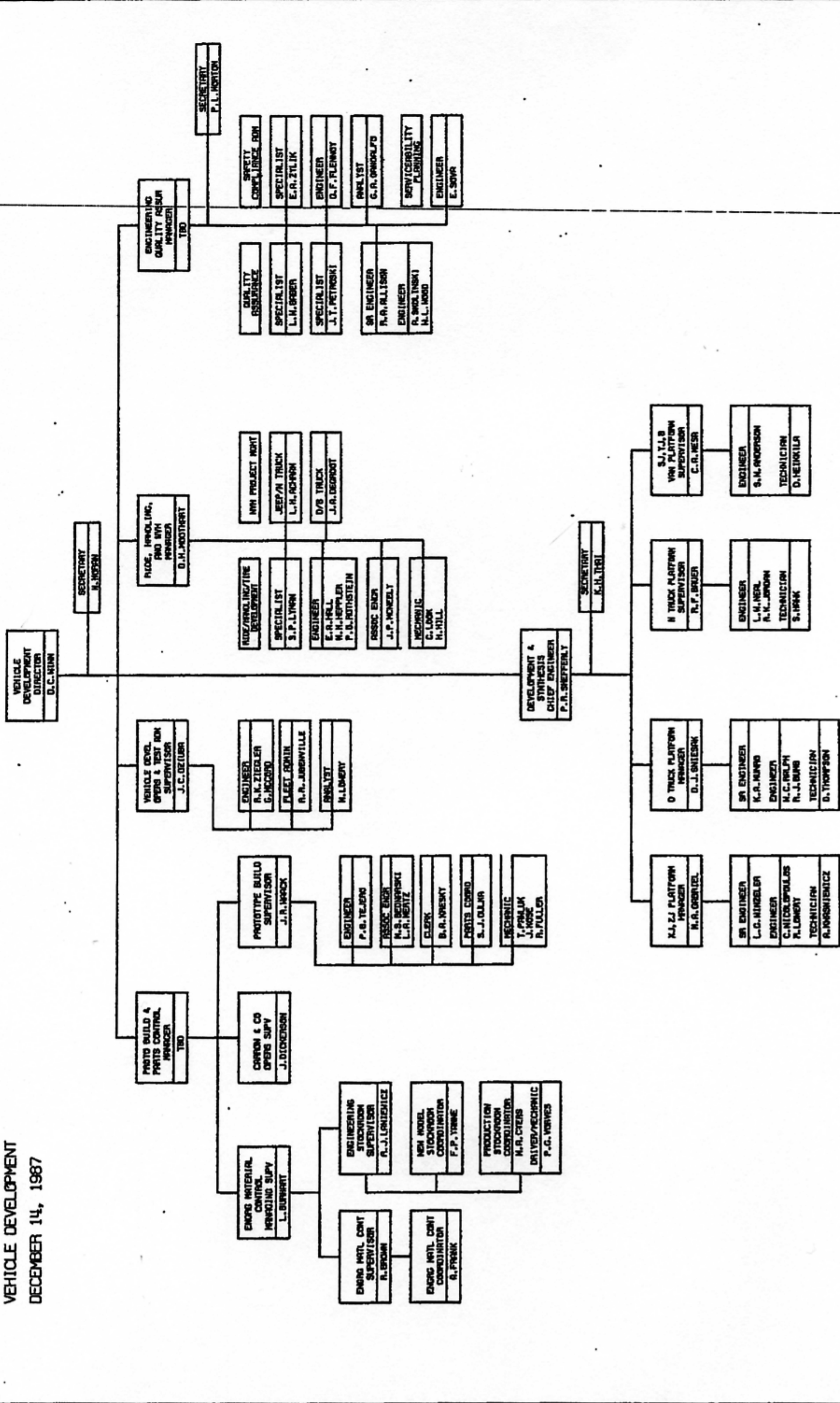

PRE-PROGRAM ENGINEERING & VEHICLE PACKAGING  
 DECEMBER 14, 1987

