

DDM Consulting  
22357 Columbia Street  
Dearborn, MI 48124  
313-277-5095  
[pvsheridan@wowway.com](mailto:pvsheridan@wowway.com)

30 April 2019

BY EMAIL

Mr. Courtney E. Morgan  
Law Office of Courtney Morgan, PLLC  
Suite 260  
3200 Greenfield Road  
Dearborn, MI 48120  
313-961-0130

**Subject: Expert Report - White / Campbell versus FCA, et al**

Dear Mr. Morgan:

In support of the subject litigation I am submitting an Expert Report in compliance with the narrow disclosure requirements of Rule 26(a)(2)(B) - i, ii, iii, iv, v and vi:

Items iv, v and vi are disclosed below/attached,

Items i, ii, and iii are summarized as follows,

In September 2018 I negotiated, in behalf of and at the request of your office, a crash test regimen that was designed to provide real-world assessment of a Fuel Tank Encapsulation Prototype. The FTEP was designed by the undersigned to execute well-known crashworthiness concepts and principles that are robust due to generality. That is, FTEP development was designed in lieu of the restrictions imposed by the following two items:

1. Mere compliance with the Federal safety standard FMVSS-301.
2. The NHTSA/DOT "reconstruction testing" as reported in July 2014.

The FTEP was designed to demonstrate the following:

- A. construction feasibility with use of common hand and common power tools,
- B. installation ease, either in production or as a retrofit,
- C. impact deflection (especially but not limited to the underride crash mode),
- D. crash force management through optimal use of and enhancement of vehicle structure
- E. protection from both on-board and off-board unfriendly impact surfaces through deployment of fuel tank encapsulation.

As such the FTEP was designed to address the concepts and concerns contained in two internal FCA documents:

- a. The memo of August 24, 1978, authored by Mr. Leonard Baker entitled, *Fuel System Design – Chrysler Passenger Cars and Trucks*
- b. The 1985 FCA Engineering Document, *Fuel Supply Systems – Design Guidelines*.

I emphasize that in development of the FTEP, I avoided restriction of its design to the refined details of the accident that took place on November 11, 2014:

- I. As stated/implied above, I sought design robustness through adherence to well-known engineering crashworthiness practices and concepts; which when optimally combined produce a design that provides technical, commercial and production feasibility.
- II. The rear underride crash accident of November 11, 2014 represents one of many foreseeable real-world events. The FTEP and the actual crash test regimen were not intended/offered as a replica of that specific event, but were designed to embrace that event as a subset of real-world crashworthiness requirements through design robustness.

The development, fabrication, and crash testing of the FTEP took place, under my direction, at Applus IDIADA KARCO Engineering, LLC in Adelanto, CA. The crash test took place on December 3, 2018.

The mechanical base of the FTEP fabrication was an aftermarket skid plate offered by SFK Manufacturing for 2002 thru 2007 KJ Jeep Liberty fuel tanks, part JP-4002, pictured here:



To the JP-4002 base was added 3/16" plate steel. The cost-of-materials related to this work:

JP-4002 <b>retail price</b> (OEM <u>cost</u> is much lower, TBD)	\$ 329 . 99
Additional 3/16" low-carbon plate steel (approximate)	55 . 00
Foam Board (used for mock-up)	15 . 45

The design, mock-up, and fabrication time for the FTEP totaled approximately five business days. Facility preparation, and the crash test at Applus IDIADA KARCO test track, took approximately two days. Final inspection took one full day. The inspection took place on December 21, 2018

The vehicle-to-vehicle rear crash test involved a 2002 Cadillac Seville **into** a 2003 Jeep Liberty KJ, and was conducted at **73.84 miles per hour**.

### Summary Comments, Conclusions, and Opinions Disclosure

I was present for all major phases of FTEP development: Design and mock-up of the FTEP, and subsequent participation-in and management-of FTEP fabrication. My presence included but was not limited to crash test vehicle selection and post-acquisition inspection, the actual crash test event of December 3, 2018 and all major preparatory work for that event, the post crash test inspection of December 21, 2018, etc.

The crash test regimen that I conducted on behalf of plaintiff proved that had FCA executive management deployed a similar but minor portion of their vast developmental engineering resources to address the issue of real world rear accident scenarios, that have and will continue to involve vehicles such as the Jeep Liberty KJ, then the following alternative outcome to that of November 11, 2014 would have prevailed:

- (a) collision breach of the rear mounted KJ fuel tank would **not** have occurred,
- (b) subsequent leakage of volatile fuel would **not** have occurred,
- (c) coincident ignition of a fuel-fed fire/conflagration would **not have** occurred.

### Document and Data Reliance Disclosure

The following exhibits have been relied upon, and will be relied upon in deposition or at-trial:

1. The memo of August 24, 1978, authored by Mr. Leonard Baker entitled, Fuel System Design – Chrysler Passenger Cars and Trucks.
2. The 1985 FCA Engineering document entitled, Fuel Supply Systems – Design Guidelines.
3. Applus IDIADA KARCO Engineering, LLC., report number TR-P38306-01-A. entitled, Protected Fuel Tank Accident Simulation - 2003 Jeep Liberty
4. Addendum to Applus IDIADA KARCO Engineering, LLC., report number TR-P38306-01-A.
5. Pictorial presentation/review of the mock-up, fabrication/construction, and installation process of the FTEP onto a typical Jeep Liberty KJ.

The video tape recordings of the crash test of the Jeep Liberty KJ FTEP, have been and will be relied upon in deposition, or at-trial. Downloadable links to the five recordings are here:

1. [http://pvsheridan.com/JeepLiberty\\_FTEP-3Dec2018/](http://pvsheridan.com/JeepLiberty_FTEP-3Dec2018/)

Please do not hesitate to contact me at any time.

Cordially,



Paul V. Sheridan  
[Business Card](#)

**Expert Witness Disclosures Under Rule 26(a)(2)(B) : iv thru vi**

- Rule 26(a)(2)(B)-(iv)      Expert witness qualifications, including a list of all publications authored in the previous 10 years:
- Qualifications:              Curriculum Vitae attached.
- Publications:                The Electric Vehicle Paradigm: EVs as a Driver of Grid  
Modernization and Sustainable Nuclear Power  
Society of Automotive Engineers (SAE) Electric Vehicle Symposium  
Shanghai, China  
Keynote Address - 12 September 2018
- 
- Rule 26(a)(2)(B)-(v)      List of all other cases, previous 4 years, witness testified as an expert at trial or by deposition:
- Commonwealth vs. Nieves Cruz, February 24, 2016
- 
- Rule 26(a)(2)(B)-(vi)      Compensation to be paid for the study and testimony in the case:
- Zero.

**PAUL VICTOR SHERIDAN**  
22357 Columbia Street  
Dearborn, Michigan 48124-3431

Home Office (313) 277-5095  
pvsheridan@wowway.com  
pvs6@Cornell.edu

### **Project Management / Administrative Experience**

*CHRYSLER CORPORATION, Detroit, Michigan* (eleven years)

Vehicle Operations - Project Manager: Product management for Dodge Caravan, Plymouth Voyager and Chrysler Town & Country minivan vehicles.

Jeep and Dodge Truck Engineering - Program Manager: Corporate documentation/communication of engineering issues for Dodge pickup and full-size van vehicles, and Dodge truck engine programs.

*FORD MOTOR COMPANY, Dearborn, Michigan.* (four years)

Product Planning Analyst - General automotive business planning. Documentation of regulatory compliance status, for Environmental Protection Agency and Department of Transportation.

### **Technical and Engineering Experience**

*STATE UNIVERSITY OF NEW YORK, Albany, New York* (three years, concurrent with B.S. education)

Nuclear Accelerator Laboratory - Assistant to the Director: Nuclear research facility operations and maintenance. Acted as laboratory 'contact person' for University and private research scientist clients.

SUNYA Computer Center - Assistant to the Director: Computer center operations and client relations.

*UNION CARBIDE CORPORATION, Sterling Forrest, New York* (one year, post A.S. education)

Nuclear Reactor Operations Trainee: Nuclear reactor operator, nuclear fuel and waste processing, radiation and health physics, radio-pharmaceutical and radio-chemical processing for medical clients.

*FAIRWAY TESTING COMPANY, STONY POINT, NEW YORK* (three years)

Heavy construction representative for Architect/Engineer. Responsible for reporting of structural steel and concrete specifications compliance. Included jobsite and fabrication plant quality control.

### **Professional Communications and Legal Experience**

*AUTOMOTIVE PRODUCT SAFETY SYSTEMS - Self Employed, Dearborn, Michigan.* (Current; 23 Years)

General Automotive Management Safety Expert: Provide testimony for injury/death plaintiffs in product liability cases. Preparation of trial evidence and documents. Accident reconstruction and expert reporting services. Expertise featured on *ABC News 20/20*, *Wall Street Journal*, *ABC News Primetime*, *Detroit News*, et al.

*AMERICAN TELEVISION AND COMMUNICATIONS CORPORATION - Albany, New York / Ithaca, New York*

Sales Manager: Cable television sales management for up to 30,000 accounts. Extensive sales staff management and customer satisfaction issues experience. Included extensive interaction with cable system engineer and installation crews (one year, 1978/9, concurrent with Cornell MBA education).

### **Formal Education**

*CORNELL UNIVERSITY-JOHNSON GRADUATE SCHOOL OF MANAGEMENT, Ithaca, New York.* May 1980.

Master of Business Administration: General Management and Business Logistics.

*STATE UNIVERSITY OF NEW YORK AT ALBANY, Albany, New York.* June 1978.

Bachelor of Science: Mathematics and Physics, minor in Computer Science.

*ORANGE COUNTY COMMUNITY COLLEGE, Middletown, New York.* June 1974.

Associate of Science: Physical Sciences, minor in Building Construction Technology.

*HENRY FORD COMMUNITY COLLEGE, Dearborn, Michigan.* May 2010.

Associate of Arts: Concentration in mathematics, computer hardware & software. Includes Microsoft 'Computer Software Applications' Certification (May 2009).

*DELFT UNIVERSITY OF TECHNOLOGY, Delft, Netherlands,* October 2018.

Professional Certification: Electric Vehicle Transportation Systems

# EXHIBIT 1

30 April 2019

Mr. Courtney E. Morgan  
Law Offices of Courtney Morgan PLLC  
Suite 260  
3200 Greenfield Road  
Dearborn, MI 48120-1802  
313-961-0130  
[cmorgan@courtneymorganlaw.com](mailto:cmorgan@courtneymorganlaw.com)

**Subject:** Expert Report - White / Campbell versus FCA, et al

Content : 2 pages

Memo of August 24, 1978, authored by Mr. Leonard Baker entitled, *Fuel System Design – Chrysler Passenger Cars and Trucks*.

Inter Company Correspondence

File Code

Date

August 24, 1978

Name & Department	Division	Plant/Office	CIMS Number
R. M. Sinclair, Director International Product Development	Product Plan. & Design Office	Chrysler Center	416-20-15
Name & Department	Division	Plant/Office	CIMS Number
L. L. Baker, Manager Automotive Safety	Engineering Office	Chrysler Center	418-12-34

Subject: Fuel System Design - Chrysler Passenger Cars And Trucks.

Pursuant to the discussions between Messrs. Vining, Jeffe, Sperlich and yourself with Mr. Mochida on August 22, the fuel system design for domestic passenger cars and trucks is summarized for Mr. Mochida's information.

Not only are the impact performance requirements of MVSS-301 pertinent to the design approach but the significant increase in the last few years in the numbers of product liability cases involving fuel system fires and the increase in the size of the awards by sympathetic juries has to be recognized. In the Ford Pinto case the NHTSA Office of Defects Investigation selected arbitrary performance criteria of minimal or no fuel leakage when the test car is impacted in the rear by a full size car at 35 mph as a basis for questioning the safety of a recall modification of the Pinto.

. Passenger Car

Fuel Tank Location

The front wheel drive configuration in Chrysler's Omni and Horizon allowed the fuel tank to be located beneath the rear seat. This location provides the protection of all of the structure behind the rear wheels—as well as the rear wheels themselves—to protect the tank from being damaged in a collision. This same location will be used in the new 1981 K-Body cars which will also have a front wheel drive.

The rear wheel drive H-Body scheduled for introduction in 1983 will have the fuel tank located over the rear axle and beneath the floor pan.

The question of whether M, R or J-Body cars should be converted to tank over axle prior to their phase-out is a matter under intensive study at this time.

Filler Neck And Cap

As the fuel tank is moved to a more forward location, the fuel fill is moved to the side of the car. The fuel cap will be recessed below the body surface and a fuel fill door provided. The fuel filler neck is designed to break away from the car body with the fuel filler cap still in place.

In this design the filler cap and fill neck or fill tube remain with the tank to avoid separation and possible fuel leakage. This side fill is scheduled for J and M-Bodies in 1980 and the Y-car in 1981.

The fuel fill is less likely to be damaged in a sideswipe when located on the right side of the car. As new models are introduced, the fuel fill will be moved to the right side of the vehicle. This may also offer greater protection to drivers who run out of gasoline on the highway, since they will fill the tank on the side away from the traffic.

#### Structure

In 1979 through 1983, the M, R, and J model cars which have the fuel tank under the floor pan behind the rear wheels, structural reinforcement of the longitudinals on each side of the tank, shielding of any unfriendly surfaces adjacent to the tank, and the design of straps and hangers to limit undesired tank movement will be employed.

#### Truck

##### Fuel Tank Location

The same principles regarding fuel tank location apply to truck design. It is important that these larger fuel tanks are not only shielded from damage in a collision but do not break away from the truck and thereby spread fuel onto the roadway. The approach used by Mitsubishi on the SP-27 of locating the fuel tank ahead of the rear wheels appears to provide good protection for the tank.

The front wheel drive 'T-115 to be introduced in 1982 will have the fuel tank ahead of the rear wheels and under the rear seat. However, in rear wheel drive trucks there is no clearance over the axle for fuel tank installation and in many cases there is insufficient space ahead of the axle for fuel tanks of the desired capacity.

Chrysler is investigating fuel tank relocation ahead of the rear wheels for vans and multi-purpose vehicles, but present plans for pickups through 1983 and for MPV's and vans through 1985 have the fuel tank located behind the rear wheels. In vehicles both with and without bumpers there is a concern with vertical height differences that create a mismatch with passenger car bumpers. Where fuel tank location behind the rear axle is all that is feasible, a protective impact deflection structure may have to be provided whether or not a bumper is provided. An investigation whether to relocate the fuel tank or to provide impact deflecting structures is presently underway.

##### Fill Neck And Cap

All trucks and vans have side fill. The sweptline pickup truck (DW 1-3) and multi-purpose vehicles (AD-1 & AW-1) will have a recessed fill cap and fuel filler door beginning in 1981.

  
L. L. Baker



## EXHIBIT 2

30 April 2019

Mr. Courtney E. Morgan  
Law Offices of Courtney Morgan PLLC  
Suite 260  
3200 Greenfield Road  
Dearborn, MI 48120-1802  
313-961-0130  
[cmorgan@courtneymorganlaw.com](mailto:cmorgan@courtneymorganlaw.com)

**Subject:** Expert Report - White / Campbell versus FCA, et al

Content : 11 pages

1985 FCA Engineering document entitled, *Fuel Supply Systems – Design Guidelines*.

PENGAD-DeVonne, M. A.  
PLAINTIFF'S  
EXHIBIT  
12  
Perion 1014100

# Fuel Supply Systems Design Guidelines

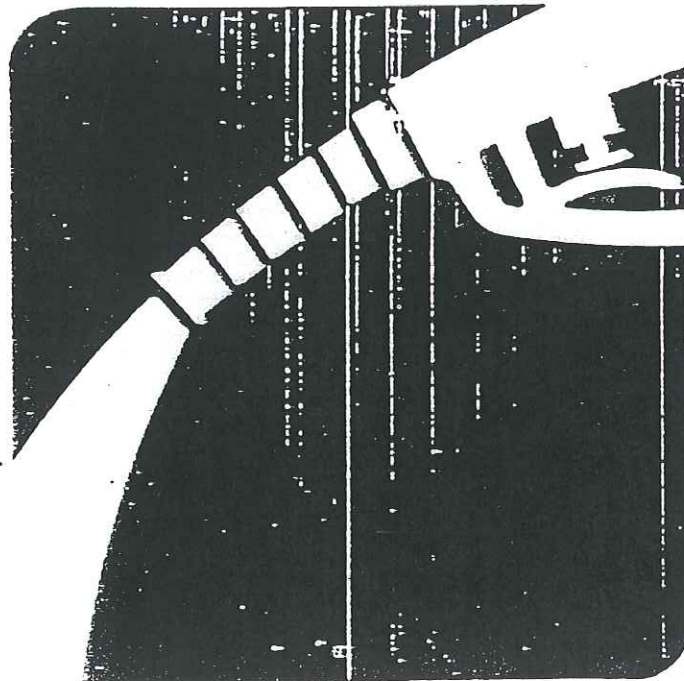

CH 0230

A-100

ST. JOHN  
Request #3  
[Fuel Supply Systems Design  
Guidelines]

# Fuel Supply System Design Guidelines

The following design guidelines for fuel supply system components will ensure that the resultant system will

- a. safely supply and store fuel.
- b. be a weight and cost effective design.
- c. have ease of manufacture.
- d. provide for easy service.
- e. comply with Federal impact regulations FMVSS 681 & 301.
- f. comply with Federal and state emission standards.
- g. give customer satisfaction.
- h. reduce warranty.
- i. be corrosion resistant.

These guidelines apply only to fuel supply systems designed in steel. As the use of lighter and more cost effective materials is developed, these guidelines will be updated accordingly.

The guidelines are considered under the following headings with safety being a primary concern in all cases:

1. Fuel Tank
  - A. Basic configuration
  - B. Packaging clearances
  - C. Detail Design and Performance
2. Tank Attachments
3. Filler Tubes
  - A. Basic configuration
  - B. Packaging clearances
  - C. Detail Design and Performance
4. Filler Caps
5. Fuel and Vapor Tubes and Hoses
  - A. Basic configuration
  - B. Packaging clearances
  - C. Detail Design and Performance
6. Sending Unit
7. Fuel Gage
8. Venting and Temperatures
9. Government Safety Standards

For any items or considerations not covered in these guidelines, please consult with the Fuel Supply Engineering Dept.

# 1. FUEL TANK

## A. Basic Configuration

1. The capacity of the tank should give a driving range of 300 miles (483 kilometers), determined by the anticipated fuel economy of the base engine, as evaluated by Performance and Development Dept.
2. The tank should be located in a manner that avoids known impact areas and provides isolation from the passenger compartment. The Fuel Supply Dept. is to be consulted during advance fuel tank packaging studies.
3. The shape of the tank should tend to that of a cube, to minimize the weight of the tank and support system.
4. The tank should have parallel sides to simplify seam welding.
5. The plan view and cross sections of the tank should be symmetrical about its axes to minimize fuel gage inaccuracies.
6. Longitudinal and lateral restraints should be provided by underbody shape to eliminate the need for strainers (e.g. L Body).
7. An integral fuel/vapor separator and roll over valve should be located in the top center of the tank eliminating the need for fully domed tanks. It is desirable to have at least 1.5 inches between the liquid level and vent orifice for carryover reduction.
8. The sending unit should be located in the top stamping of the tank, with a

sump effect provided for the float pickup in the bottom stamping to prove gage accuracy.

9. The sending unit should be capable of being serviced without removal of tank.
10. The tank should be serviced with removal of adjacent components.
11. The design of the fuel tank and supply system should not be compromised for bumper or platform hitches. It is the responsibility of Hitch-Releasing Dept. to insure the performance of the fuel system defined in these guidelines, not be paired.
12. No offset flanges—see fig. 1.1.
13. Tank flanges, formations and reinforcements should be configured as not to entrap corrosive agents.

## B. Packaging Clearances

1. Ground clearance—The minimum fuel tank clearance to ground is (76 mm) measured by design under dynamic full jounce metal (includes tire deflections and calculated for the dynamic tire load conditions of the particular vehicle).—see fig. 1.2.

### 2. Departure Line

#### a. Tank Rear of Axle.

0.25" (6.4 mm) clearance must be maintained between the tank and departure line determined by a test constructed between the bottom

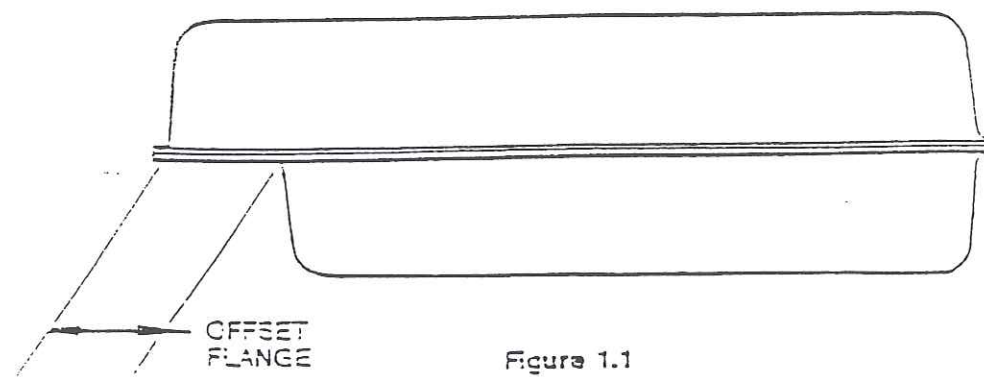

Figure 1.1

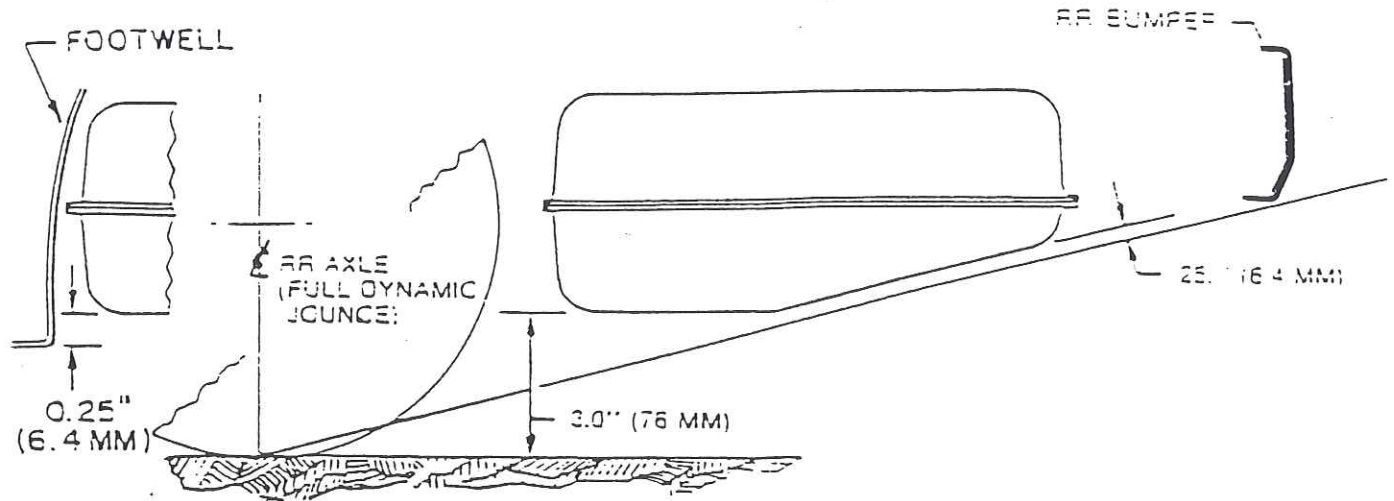

Figure 1.2

the tire centerline at full jounce and the bottom edge of the bumper, tie down skid plates or structurally sound license plate bracket.—see fig. 1.2.

b. Tank Ahead of Axle.

The tank should not fall below a horizontal line drawn 0.25" (6.4 mm) above the tangent to the rear seat foot well or other nearby leading structural member.—see fig. 1.2.

3. Spring Clearance—The minimum clearance to the tank flange is 2" (50.8 mm) static and 0.75" (19.1 mm) under dynamic sway deflection.—see fig. 1.3.
4. Rail Clearance—A minimum of 2.0" (50.8 mm) clearance between the fuel tank and underbody rail.—see fig. 1.3.

5. Exhaust Clearance—A minimum of 1.5" (38.1 mm) between exhaust component and tank, and 1.0" (25.5 mm) to tank flange.—see fig. 1.3.

6. Axle, Bumper and Shock Absorber—This clearance to be determined by combination of Advanced Body Design crush analysis and actual multi-vehicle FMVSS 301 rear impact. No contact should occur between these components and the tank during the impact event. All components must present a smooth and friendly surface to the tank (axle vent, brake tee, shock plate, bumper, etc.).

7. Shock and Spring Shackle Access—Tank must permit service of shock absorber and spring shackle with folding tank flanges.

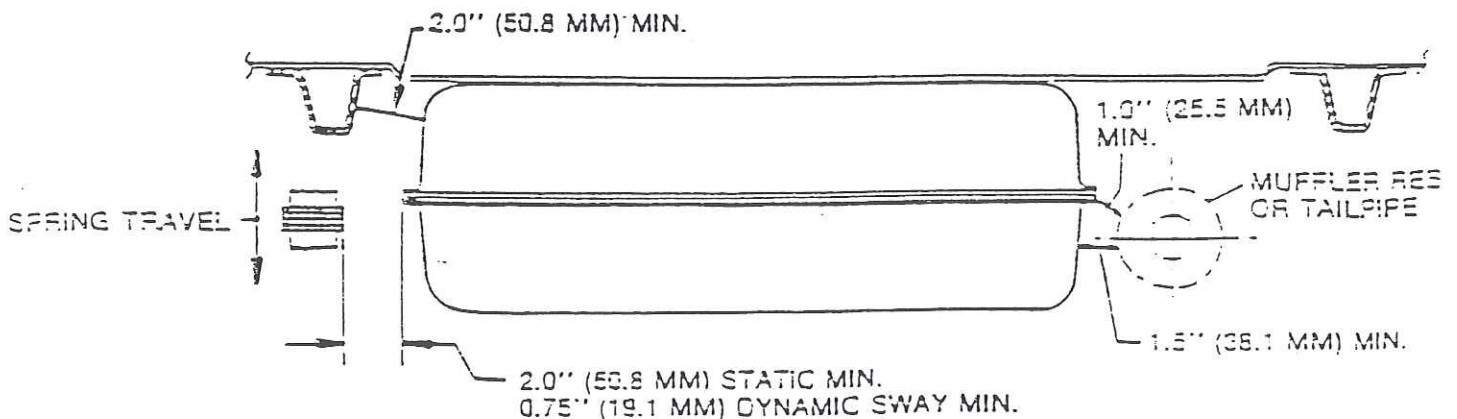

Figure 1.3

8. Shipping Tie Down Provision—A minimum of 0.5" (12.7 mm) clearance must be maintained between body tie down provisions and the tank (this includes removable shackles).

C. Detail Design and Performance

1. Tank Capacity—The usable capacity of the tank is determined as follows:

With tip angles of 16° fore and aft and 14° side to side the fuel level should not be higher than the venting point of the roll over valve. The volume below the limiting, tip angle surface represents: (unusable fuel ÷ usable fuel) × (1 + thermal expansion) where:

$$\text{unusable fuel} = 0.3 \text{ gallons (1.25l)}$$

$$\text{thermal expansion} = 0.027 (\Delta T = 40^\circ F)$$

Hence the usable fuel capacity of a given tank and roll over valve configuration can be determined.

2. Body Tolerances

- a. = 0.06" (1.5 mm) for locating any one floor pan strainer to the floor pan centerline.

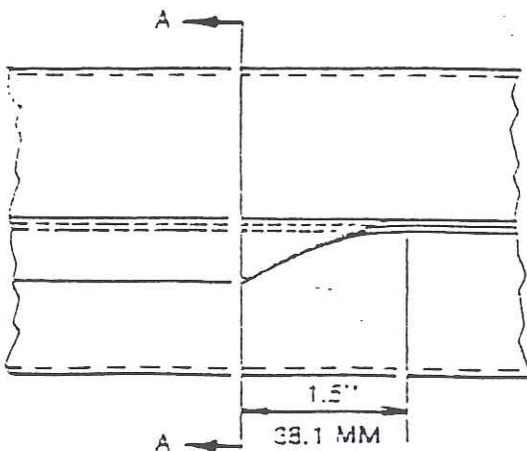

- b. = 0.06" (1.5 mm) lateral tolerance between one floor pan strainer to the other.  
c. = 0.06" (1.5 mm) longitudinal tolerance between strainers.

3. Tank Location—Lateral and longitudinal location to be provided by body formations (such as seat formations in L Body). For tanks located by strainers:

Lateral—location provided by tank locating off one strainer permitting the other to float.

Longitudinal—locate off strainer at the front and strap at the rear.

4. Design line to line clearance between tank and floor pan or floor pan beads. If insulator pad is used, allow for 0.05" (1.3 mm) pad thickness (No pad is to be used unless mandated by Sound Lab).

5. Flange bend radius to be 0.08" (2.0 mm) minimum. See fig. 1.4.

6. Flanges should not be folded, but where required, the transition from fold to normal will be 1.5" (38.1 mm). In general, all folds are to be in downward direction (see fig. 1.4). Folds :

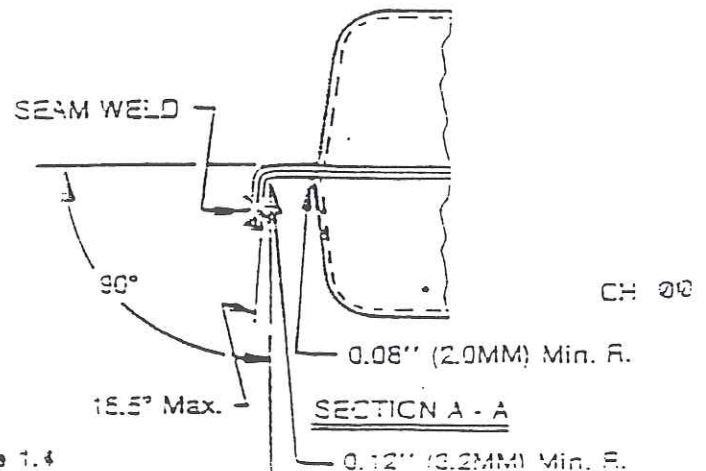

Figure 1.4

the support strap locations may be upwards if this provides the most friendly bearing surface. Maximum bend to be 90° with 15° tolerance. Fold radius to be 0.12" (3.2 mm) minimum.

7. Location of seam welds.
  - a. With fold—to be located outside of fold—see fig. 1.4.
  - b. Without fold—to be located .025" (6.4 mm) from wall of tank (ref. P.S.-1755).
8. All manufacturing pre-seam weld spot welds must be located outside of seam weld path.
9. Ribs
  - a. Ribs will be at least 0.25" (6.4 mm) deep.
  - b. Rib neutral axis should be at half rib depth.
  - c. Rib transition to normal surface should occur on vertical tank wall

within 0.25" (6.4 mm) from flange. Round end rib face out must not be used. See fig. 1.5 for correct fade out. Rib character to be accurate in A-1 model.

- d. Rib configuration to be agreed to by Stamping Division.
10. Minimum & Maximum Material Thickness

To be ducted on drawing with the minimum resulting from combined testing of:

  - a. PV (Pressure Vacuum)
 

500 cycles at pressure limits of cap followed by 2000 cycles at 60% of pressure limits. (P.S. 1764)
  - b. Shake
 

Testing to PS1764.
  - c. Impact:
 

FMVSS 301 impact testing.

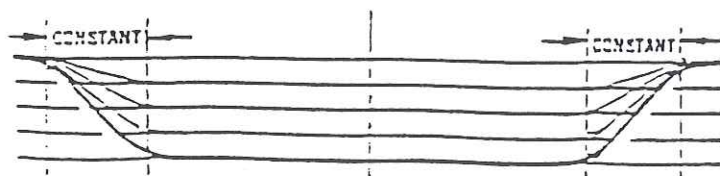
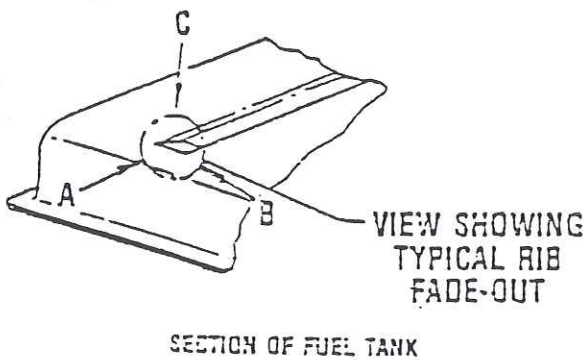

VIEW IN DIRECTION OF ARROW A

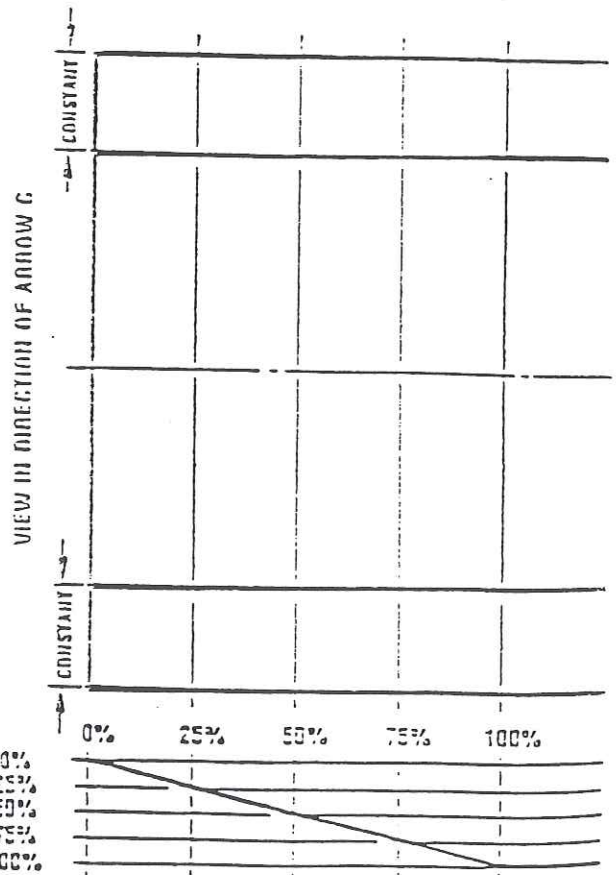

VIEW IN DIRECTION OF ARROW B

Figure 1.5

d. P.G. (Proving Ground)

50,000 miles (80 000 km) of general endurance testing, or 25,000 miles (40 000 km) of accelerated endurance testing.

11. Manufactured tanks to be tested for leaks etc.. to PS1764.
12. Date codes will be stamped in appropriate size characters on bottom surface of stamping. Sharp corners are to be avoided.
13. Filler tube openings may require reinforcing if determined by impact testing.

## 2. TANK ATTACHMENTS

1. The straps are to be equispaced about the longitudinal centerline of the tank to equalize strap loads under operating and impact conditions.
2. Two identical straps are to be used.
3. The strap T-slot end is folded for double thickness.
4. The T-slot end will be the rear attachment unless otherwise agreed with SAO.
5. The strap bolted end is to be folded for double thickness.
6. Developed strap length will be determined by laboratory fitting on Program cars. Preliminary developed lengths will be determined by design.

7. Functional gaging to be called out on tail drawing to check strap lengths.
8. If required, rolled edges should have a cross section as shown in fig. 2.
9. With positive wire connection for sending unit ground circuit, material may be either terne or galvanized for corrosion protection. Straps to be terne if no positive ground circuit used.
10. Material thickness will be determined as for tanks in section 1.C.10.
11. Straps should shield openings at the front of strainers to minimize corrosion.
12. Between the tank and the underbody attachments, the strap should be perpendicular to the weld flange of the tank.

## 3. FILLER TUBE

### A. Basic Configuration

1. Preferred location is right side of vehicle with provisions to avoid separation of the tube from tank during impact.
2. Design layout should assume 2" (50 mm) O.D. tube.
3. Filler tube should enter the center side of the tank to minimize filling variations.
4. Filler tube to determine fuel level without external vent.

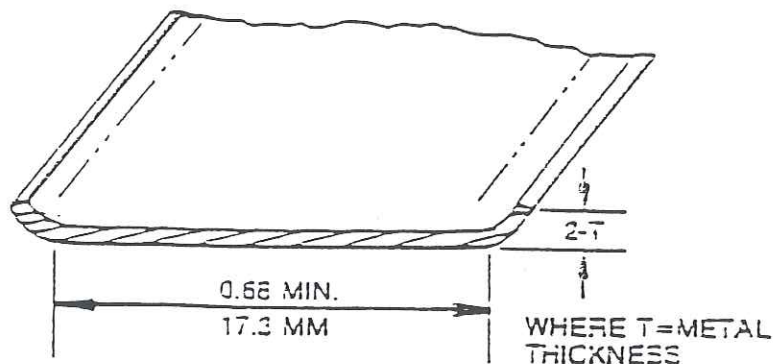

Figure 2



5. Filler tube should be straight. If bends must be employed to facilitate packaging, all bends should be in one plane, if possible.
6. Must accommodate requirements of California vapor recovery for both leaded and unleaded filler tubes.
7. To be serviceable without removal of tank or other components.
8. Accept fill with 1 gallon (3.8 l) gas can. See layout 7730-36F-SK4557.

#### B. Packaging Clearances

1. Nominal clearance to fixed body components 0.5" (12.7 mm).
2. If tube passes through tire wheelhouse, minimum tire clearance should be 3.0" (76.2 mm) at full jounce.
3. If filler tube breakaway housing is used and it is located within wheelhouse, filler tube housing drain must be located away from radial wheel splash and hot exhaust components. Care should be taken in locating drain hole to assure that gasoline drainage does not attack sealing areas of lower wheelhouse.
4. Minimum clearance to spring 0.75" (19.1 mm) dynamic roll and 2.0" (50.8 mm) static full jounce.
5. Filler tube tank grommet must be 5.0" (127.00 mm) from exhaust.
6. For rear fills, fully stroked bumper components to be 0.25" (6.4 mm) from filler tube and present a smooth surface.
7. Fasteners are to be pointed away from filler tube. See design standard 31.17.
8. All surrounding components are to present a smooth friendly surface.

#### C. Detail Design and Performance

1. Minimum centerline bend radius should be 5.0" (127.0 mm) to permit less costly press rather than mandrel bends.

2. Minimum length of straight tube between bend tangents to be equal to tube diameters.
3. Baffling or vent tube to permit filling 15 g.p.m. (56.9 l) without spray or spit back, or premature shut off is lined in Fuel Supply Dept. labora procedure.
4. Filler tube must accommodate sembly plant filling process.
5. For impact considerations, the tube must:—
  - a. Penetrate grommet by at least 2 (69.9 mm).
  - b. The filler tube grommet sealing of the filler tube is to be sized to w 0.015" of the nominal tube diam and be smooth without disconti in an area of = 2.0" (50.8 mm) c designed seal location.
  - c. The surface of the filler tube v two inches of the grommet is to b of underbody sealer.
6. For corrosion purposes side fill must be lead dipped. Rear fill may be lead dipped or terne material.
7. Leaded fuel restrictor to compi the Federal requirement of preve insertion of leaded filler nozzle restricting the amount of leade that would be added, if attempt 700 cc.
8. Restrictor to pass life cycle of insertions of unleaded nozzle.
9. Maximum angularity of filler t grommet to be 10°.
10. When the filler tube is articula the tank grommet, it must not c contact with any part of the s unit. To accommodate ass techniques it may be necessary; foam tube stops. Beads as as aics are to be avoided.
11. Compliance with the Californi recovery standard is establis design. Guidelines for confi. are shown on layout 7730-36F-SK4557.

7730-36F-SK4507  
7730-36F-SK4508

Standard nozzle guidelines are shown on layout 7730-36F-SK4557.

12. The filler tube should enter the fuel tank at a downward angle under all loading conditions.

#### 4. FILLER CAPS

1. Relative to the sealing face of the filler tube the minimum clearances required to accommodate all threaded caps (both standard and locking) are shown on 7730-36F-SK4510.
2. Pressure settings are to be common to all caps to decrease emission families:—  
  
Vacuum—10" (254 mm) H<sub>2</sub>O  
Pressure—Determined by the maximum static head of fuel that can be applied to the cap with the vehicle at any attitude plus a 3" (76.2 mm) water margin of safety. This represents minimum cap setting. The maximum is to be determined by the PV test described in 1. C. 10a.
3. Caps to comply with PF5017.
4. Caps to comply with FMVSS 581 & 501 impact testing.
5. Durability to be established by 50,000 miles (80 000 km) general endurance running.
6. If subject to impact, caps are to retain their sealing capabilities.
7. No cap to have English wording without French equivalent having equal prominence.

#### 5. FUEL AND VAPOR TUBES AND HOSES

##### A. Basic Configuration

1. Lines shall be one piece from the fuel tank to engine compartment and routed in a manner that eliminates the need of molded hoses.

2. For simplification and to avoid mis-builds, lines and hoses should be identical for all engine combinations in a particular car line. Where this is not possible the combinations of lines and hoses should be foolproofed by design.

3. For a car line with more than one wheel base, the low volume W.E. lines are to be color coded.

4. The fuel, return and vapor lines and hoses must not interfere with the removal and installation of serviceable parts.

5. Fuel line clips and hose clamps should be serviceable without removal of other components.

6. Clamps, clips and screws are to be standardized.

7. Armor Usage.

No armor is to be used on lines unless:—

- a. Determined by the Corrosion Laboratory to be necessary to prevent premature corrosion failures.
- b. Established by general endurance testing to minimize stone damage in critical areas.
- c. Required for protection of lines during impacts.

##### B. Packaging Clearances

1. In the engine compartment a minimum of 1.0" clearance between the engine and the lines and hose must be maintained during body drop.
2. All screws and clamps to have acceptable tool clearances. To be determined in cooperation with SAC chassis and underbody mock-ups.
3. For impact considerations, no sharp objects are to be pointed at the fuel supply and return lines within 2.0 (50.8 mm) (refer to drafting standard 31.17). Nor should they be located where they may be severed during impact.

4. Fuel hoses must clear exhaust components by 5" (127 mm).
5. Fuel hoses to be routed with 4" (102 mm) clearance to engine accessory drive belts.

Dia.	Minimum Radii at Centerline
3/16" (4.7 mm)	3" (76.2 mm)
1/4" (6.4 mm)	3" (76.2 mm)
5/16" (7.9 mm)	4" (101.6 mm)
3/8" (9.5 mm)	5" (127.0 mm)

### C. Detail Design and Performance

1. For layout purposes provision should be made to bundle:—

Fuel supply 3/8" (9.5 mm) Dia.  
 Fuel return 3/8" (9.5 mm) Dia.  
 Vapor 1/4" (6.4 mm) Dia.

Desired usage is:—

Fuel supply 5/16" (7.9 mm)  
 Fuel return 1/4" (6.4 mm)  
 Vapor 3/16" (4.7 mm)

Larger sizes will only be used if dictated by applications such as EFM.

2. Tube material to be MS1806 steel (optional MS3235) with a wall thickness of 0.028" (0.71 mm), lead alloy coated to PS954B and inspected for cleanliness to PS3930.
3. Seal formation and hose stop to PS1797. To minimize possibility of hose cutting during impact, no burrs are permitted.
4. Hose material to be rubber and fabric MSEA212.
5. Bend Radii

#### a. Lines

Only two radii per line diameter permissible.

Dia.	Radii at Centerline	Bend
3/16" (4.7 mm)	0.5" (12.7 mm), 1.5" (38.1 mm)	90° Maximum
1/4" (6.4 mm)	0.5" (12.7 mm), 1.5" (38.1 mm)	90° Maximum
5/16" (7.9 mm)	0.62" (15.9 mm), 1.5" (38.1 mm)	90° Maximum
3/8" (9.5 mm)	0.75" (19.1 mm), 1.5" (38.1 mm)	90° Maximum

#### b. Hoses

To avoid hoses kinking, the minimum

6. With the aid of SAD it must be determined if pre-bundled or single line installations are more economical. Compatible clipping will then be designed.
7. Hoses must be located so that a broken exhaust component will not result in failure from exhaust gas impingement.
8. Lines and hoses are to be routed to protect them from being cut by collapsing leaf springs.

## 6. SENDING UNITS

1. The sending unit should be located in top stamping of the tank or on a surface that is not in line with the axle bowl or shock absorber or where it is likely to be damaged during impact.
2. For overall accuracy the sending unit must have positive bottom reference.
3. The float is to be located as close to the center of the tank as possible to minimize gauge fluctuations during various vehicle maneuvers and loading conditions.
4. The output of the sending unit is to be linear relative to fuel capacity.
5. Sending units will have positive wire connection for the ground circuit.
6. Servicing of the sending unit should be accomplished without removal of the tank or other components.
7. The fuel filter must comply with MS3539 for standard units and PF5256 for EFM units. In both cases the filter must be capable of picking up all of the usable fuel, as defined in 1.C.1.

## 7. GAGE

1. Although every effort is made to make the combined output of the sending unit and gage linear, the graduations of the fuel gage are to truly reflect the actual fuel capacity.
2. The empty reserve is to be minimal so that its range is from zero to 10% of tank capacity.
3. The full reserve shall be that amount of fuel to always assure a full or beyond gage reading within the design limitation set forth in PF3865.

## 8. VENTING AND TEMPERATURES

1. A full tank must vent under the following conditions:—
  - a. 16° fore and aft vehicle attitude
  - b. 14° side to side vehicle attitude
  - c.  $\Delta T$  of 40°F combined with a. and b.
  - d. The AMA cycle with zero carry over. (0.7 g acceleration and deceleration; 0.4 g cornering.)
2. Temperatures

The following fuel supply system temperature goals exist for fuel levels in excess of a half tank. Fuel levels may raise the temperature goals of the tank surface and fuel another 20°F. Component relocation or shielding must be considered if these goals are exceeded.

## INSTRUMENTATION DEFINITIONS FOR FUEL SYSTEM

Thermocouple Location	Long Term Goals		Short Term Goals	
	F	C	F	C
F/Tnk. Surface	150	65.6	160	71.1
F/Tnk Nrst Resonator	150	65.6	160	71.1
Fuel Temp. in F/Tnk.	130	54.4	140	60.0
Fuel Temp. at Axle Kickup	130	54.4	150	65.6
Fuel Temp. at F/Tnk. Outlet	130	54.4	150	65.6
Fuel Temp. TB/HS Int. U/Fnt. P/w1	130	54.4	150	65.6
Fuel Line-rubber hose connections (all locations)	160	82.2	250	121
RR W/Well F/Line Clo Nrst. Exn.	150	65.6	150	65.6
F/Vapor Temp. at F/Tnk. Int.	120	48.9	120	48.9
R/O Val. Ext. Surf.	250	121	300	149

## 9. GOVERNMENT SAFETY STANDARDS

1. FMVSS 581—Bumper Impact Standard

All changes to the fuel supply components will be reviewed for compliance with the subject standard and confirming tests run where judged necessary.

2. FMVSS 301—Fuel Integrity Standard

The Fuel Supply Department has the overall responsibility for meeting the subject standard. A 301 steering committee, chaired by the Fuel Supply Department, meets bi-weekly to review compliance status. This forum is used to evaluate changes to the vehicle for their possible effect on the standard and to arrange for any necessary testing, and/or changes.

### Note:

IT IS INCUMBENT ON THE DEPTS. MAKING CHANGES TO ADVISE THE 301 STEERING COMMITTEE IF THEY FEEL THAT THE CHANGES MAY AFFECT COMPLIANCE WITH FMVSS 301

## EXHIBIT 3

30 April 2019

Mr. Courtney E. Morgan  
Law Offices of Courtney Morgan PLLC  
Suite 260  
3200 Greenfield Road  
Dearborn, MI 48120-1802  
313-961-0130  
[cmorgan@courtneymorganlaw.com](mailto:cmorgan@courtneymorganlaw.com)

**Subject:** Expert Report - White / Campbell versus FCA, et al

Content : 91 pages

Applus IDIADA KARCO Engineering, LLC., report number TR-P38306-01-A. entitled,  
*Protected Fuel Tank Accident Simulation - 2003 Jeep Liberty*

TEST REPORT FOR:

***Law Office of Courtney Morgan, PLC***  
***2003 Jeep Liberty***



TESTED TO:

***Protected Fuel Tank Accident Simulation***  
***2003 Jeep Liberty***

PREPARED FOR:

***Law Office of Courtney Morgan, PLC***  
***3200 Greenfield, Suite 260,***  
***Dearborn, Michigan 48120***  
***Phone 313-961-0130***

TEST REPORT NUMBER:

***TR-P38306-01-A***

REPORT DATE:

***February 25, 2019***

TEST DATE:

***December 3, 2018***

---

**Applus IDIADA KARCO Engineering, LLC.**  
Automotive and Safety Testing Facility  
9270 Holly Road, Adelanto, CA 92301  
Tel: (760) 246-1672 Fax: (760) 246-8112  
[www.KARCO.com](http://www.KARCO.com)

Applus IDIADA KARCO Engineering compiled this publication for information gathering only. The findings and conclusions expressed in this publication are those of the authors and not necessarily those of any other organization. Applus IDIADA KARCO Engineering provides test services only and is not involved in consulting, product design or the manufacturing of any automotive products. Applus IDIADA KARCO Engineering does not warrant, supervise or monitor compliance of products or services except as specifically agreed to in writing. By their very nature, testing, analysis and other Applus IDIADA KARCO services are limited in scope and subject to expected measurement variability. No activity by Applus IDIADA KARCO Engineering can release a manufacturer from product or any other liability. The results, findings and conclusions expressed in this publication relate only to the items tested for the specific situation simulated in the test.

Tested By: Amjad A. Jadallah  
Mr. Amjad A. Jadallah  
Project Engineer

Report By: Amjad A. Jadallah  
Mr. Amjad A. Jadallah  
Project Engineer

Reviewed By: Andrew J. Espindola  
Mr. Andrew J. Espindola  
Quality Assurance Manager

Approved By: Michael L. Dunlap  
Mr. Michael L. Dunlap  
Director of Operations

Approval Date: February 25, 2019





## TABLE OF CONTENTS

<u>Section</u>		<u>Page</u>
1	Introduction	1
2	Test Summary	3
3	Data Sheets	4
<u>Data Sheet</u>		<u>Page</u>
1	General Test Information	5
2	Test Data	6
<u>Appendix</u>		<u>Page</u>
A	Photographs	A

**SECTION 1**  
**INTRODUCTION**

This report presents the results of a vehicle to vehicle rear impact test conducted with a 2002 Cadillac Seville SLS V-8 FWD automatic (Bullet Vehicle) and a 2003 Jeep Liberty 4WD V-6 automatic (Target Vehicle) which was equipped with a Fuel Tank Encapsulation Prototype (FTEP). The objective of this test was to evaluate the fuel tank crashworthiness integrity of a 2003 Jeep Liberty equipped with a Fuel Tank Encapsulation Prototype when subjected to the impact conditions described in this report. This test was conducted at Applus IDIADA KARCO Engineering's test facility in Adelanto, California on December 3, 2018.

## **SECTION 2**

### **TEST PROCEDURE**

This test was conducted according to instructions supplied by Paul V. Sheridan of DDM Consulting. A 2003 Jeep Liberty equipped with a Fuel Tank Encapsulation Prototype was impacted on its rear end by a 2002 Cadillac Seville SLS at a velocity of 73.84 mph. The vehicles were aligned so that the bullet vehicle's longitudinal centerline intersected the target vehicle's longitudinal centerline. The test was conducted by Applus IDIADA KARCO Engineering, LLC. in Adelanto, CA on December 3, 2018 in accordance with instructions provided by DDM Consulting. The rear end impact was recorded by Three (3) high speed and two (2) real-time cameras.

The 2003 Jeep Liberty was equipped with a Fuel Tank Encapsulation Prototype. The FTEP was constructed by modifying a skid plate manufactured by SFK Manufacturing, Model JP-4002. The design process, fabrication, and installation of the modifications made to the skid plate were done under the direction of Paul V. Sheridan. A series of steel plates with a thickness of 3/16" were welded to the skid plate to encapsulate the target vehicle's fuel tank, a single 1/2" thick plate was used on part of the mounting surface of the FTEP. A photo of the short 1/2" thick plate used can be found in Figure 53 of Appendix A. The FTEP was mounted to the vehicle's rear frame rails using the six bolts originally used to mount the trailer hitch to the vehicle and to the rear transverse rail by four additional bolts and nuts. The vehicle's fuel tank was painted yellow and the FTEP was painted orange for photographic purposes.

The 2002 Cadillac Seville SLS was drained of all its fluids. The fuel tank was left empty for the test. The vehicle's front end was lowered 2.25 inches measured at the forward most point of the vehicle's front bumper by compressing the front suspension with ratchet straps and attached to the vehicle body and lower control arms. Additional details related to the test vehicles is presented on Data Sheet 1.

**SECTION 3**  
**TEST SUMMARY**

A 2002 Cadillac Seville SLS impacted the rear end of a 2003 Jeep Liberty equipped with an FTEP at a velocity of 73.84 mph. Upon impact, the bullet vehicle's front end impacted and drove underneath the target vehicle's rear end and FTEP, effectively pushing the target vehicle's rear end upward. Immediately after the impact, the odor of Stoddard solvent was present and drops of solvent were observed on the ground near the rear end of the target vehicle. The amount of solvent observed was immeasurable.

A post-test inspection of the FTEP and the 2003 Jeep Liberty's fuel tank was conducted on December 21, 2018. The FTEP remained attached to the vehicle by all but the three right side frame rail bolts. The fuel tank remained attached to the vehicle by the OEM strap attachments. Upon removal of the FTEP and fuel tank from the vehicle, a plastic output nipple on the top of the fuel tank was found cracked. The Stoddard solvent was drained from the vehicle to confirm that no measurable amount of solvent leaked as a result of the impact test. The driver side doors on the target vehicle were operable after the impact, the outside door handle on the right front passenger door was broken but the door was operable using the interior door handle, the right rear passenger door was jammed shut.

**SECTION 3  
DATA SHEETS**

Test Article: 2003 Jeep Liberty Project No.: P38306-01  
 Test Program: Protected Fuel Tank Accident Simulation Test Date: 12/03/18

**CONVERSION FACTORS**

Quantity	Typical Application	Std Units	Metric Unit	Multiply By
Mass	Vehicle Weight	lb	kg	0.4536
Linear Velocity	Impact Velocity	miles/hr	km/hr	1.609344
Length or Distance	Measurements	in	mm	25.4
Volume	Fuel Systems	gal	liter	3.785
Volume	Small Fluids	oz	mL	29.574
Pressure	Tire Pressures	lbf/in <sup>2</sup>	kPa	6.895
Temperature	General Use	°F	°C	$= (T_f - 32) / 1.8$
Force	Dynamic Forces	lbf	N	4.448
Moment	Torque	lbf-ft	N•m	1.355

## DATA SHEET 1

### GENERAL TEST INFORMATION

Test Article: 2003 Jeep Liberty Project No.: P38306-01  
Test Program: Protected Fuel Tank Accident Simulation Test Date: 12/03/18

### TARGET VEHICLE INFORMATION

Year	2003
Make	Jeep
Model	Liberty
Body Style	5-Door MPV
VIN	1J4GL48K03W694185
Color	Silver
Manufacture Date	Apr-03

### TARGET VEHICLE WEIGHT

	As Tested Weight		
	Front	Rear	Total
Left	1099	981	2080
Right	1068	947	2015
Ratio (%)	52.9	47.1	100.0
Total	2167	1928	4095

### BULLET VEHICLE INFORMATION

Year	2002
Make	Cadillac
Model	Seville SLS
Body Style	4-Door Sedan
VIN	1G6KS544624177876
Color	Tan
Manufacture Date	Oct-01

### BULLET VEHICLE WEIGHT

	As Tested Weight		
	Front	Rear	Total
Left	1232	687	1919
Right	1195	709	1904
Ratio (%)	63.5	36.5	100.0
Total	2427	1396	3823

**DATA SHEET 2**

**TEST DATA**

Test Article: 2003 Jeep Liberty Project No.: P38306-01  
Test Program: Protected Fuel Tank Accident Simulation Test Date: 12/03/18

**TEST DATA**

Test Date	12/3/2018
Test Time	4:30 P.M.
Temperature (°F)	67
Wind Speed (mph)	5
Wind Direction	N
Impact Velocity (mph)	73.84

**IMMEDIATE POST-TEST SOLVENT DATA**

- A. From impact until vehicle motion ceases: 0 oz.  
(Maximum allowable = 1 oz.)
- B. For the 5 minute period after motion ceases: 0 oz.  
(Maximum allowable = 5 oz.)
- C. For the following 25 minutes: 0 oz.  
(Maximum allowable = 1 oz./minute)

D. Spillage Details: The odor of solvent was present.  
Droplets of solvent appeared on the ground.  
\_\_\_\_\_  
\_\_\_\_\_

**APPENDIX A  
PHOTOGRAPHS**



## LIST OF PHOTOGRAPHS

<u>Figure</u>		<u>Page</u>
1	2003 Jeep Liberty as Received View	A-1
2	2003 Jeep Liberty as Received View	A-1
3	2003 Jeep Liberty Vehicle Manufacturer's Label	A-2
4	2002 Cadillac Seville SLS as Received View	A-2
5	2002 Cadillac Seville SLS as Received View	A-3
6	2002 Cadillac Seville SLS Vehicle Manufacturer's Label	A-3
7	Pre-Test 2003 Jeep Liberty Fuel Tank	A-4
8	Pre-Test 2003 Jeep Liberty Fuel Tank	A-4
9	Pre-Test 2003 Jeep Liberty Fuel Tank	A-5
10	Pre-Test 2003 Jeep Liberty Fuel Tank	A-5
11	Pre-Test 2003 Jeep Liberty Fuel Tank	A-6
12	Pre-Test 2003 Jeep Liberty Fuel Tank	A-6
13	Pre-Test 2003 Jeep Liberty Fuel Tank	A-7
14	Pre-Test 2003 Jeep Liberty Fuel Tank	A-7
15	Pre-Test 2003 Jeep Liberty Fuel Tank	A-8
16	Pre-Test 2003 Jeep Liberty Fuel Tank	A-8
17	Pre-Test 2003 Jeep Liberty Fuel Tank	A-9
18	Pre-Test 2003 Jeep Liberty Fuel Tank	A-9
19	2003 Jeep Liberty Fuel Tank	A-10
20	2003 Jeep Liberty Fuel Tank	A-10
21	2003 Jeep Liberty Fuel Tank	A-11
22	2003 Jeep Liberty Fuel Tank	A-11
23	2003 Jeep Liberty Fuel Tank	A-12
24	2003 Jeep Liberty with Fuel Tank Removed	A-12
25	2003 Jeep Liberty with Fuel Tank Removed	A-13
26	2003 Jeep Liberty with Fuel Tank Removed	A-13
27	2003 Jeep Liberty with Fuel Tank Reinstalled	A-14
28	2003 Jeep Liberty with Fuel Tank Reinstalled	A-14
29	2003 Jeep Liberty with Fuel Tank Reinstalled	A-15
30	2003 Jeep Liberty with Fuel Tank Reinstalled	A-15
31	2003 Jeep Liberty with Fuel Tank Reinstalled	A-16
32	2003 Jeep Liberty with Fuel Tank Reinstalled	A-16
33	2003 Jeep Liberty with SFK Manufacturing Model JP-4002 Skid Plate Installed	A-17

## LIST OF PHOTOGRAPHS

<u>Figure</u>		<u>Page</u>
34	2003 Jeep Liberty with SFK Manufacturing Model JP-4002 Skid Plate Installed	A-17
35	2003 Jeep Liberty with SFK Manufacturing Model JP-4002 Skid Plate Installed	A-18
36	2003 Jeep Liberty with SFK Manufacturing Model JP-4002 Skid Plate Installed	A-18
37	2003 Jeep Liberty with SFK Manufacturing Model JP-4002 Skid Plate Installed	A-19
38	2003 Jeep Liberty with SFK Manufacturing Model JP-4002 Skid Plate Installed	A-19
39	2003 Jeep Liberty with Fuel Tank Removed	A-20
40	2003 Jeep Liberty with Fuel Tank Removed	A-20
41	2003 Jeep Liberty with Fuel Tank Removed	A-21
42	2003 Jeep Liberty Fuel Tank Encapsulation Prototype Design Process	A-21
43	2003 Jeep Liberty Fuel Tank Encapsulation Prototype Design Process	A-22
44	2003 Jeep Liberty Fuel Tank Encapsulation Prototype Design Process	A-22
45	2003 Jeep Liberty Fuel Tank Encapsulation Prototype Design Process	A-23
46	2003 Jeep Liberty Fuel Tank Encapsulation Prototype Design Process	A-23
47	2003 Jeep Liberty Fuel Tank Encapsulation Prototype Design Process	A-24
48	2003 Jeep Liberty Fuel Tank Encapsulation Prototype Design Process	A-24
49	2003 Jeep Liberty Fuel Tank Encapsulation Prototype Design Process	A-25
50	2003 Jeep Liberty Fuel Tank Encapsulation Prototype Design Process	A-25
51	2003 Jeep Liberty Fuel Tank Encapsulation Prototype Design Process	A-26
52	2003 Jeep Liberty Fuel Tank Encapsulation Prototype Design Process	A-26
53	2003 Jeep Liberty Fuel Tank Encapsulation Prototype Design Process Showing ½" Plate	A-27
54	2003 Jeep Liberty with Fuel Tank Re-Installed	A-27
55	2003 Jeep Liberty with Fuel Tank Re-Installed	A-28
56	2003 Jeep Liberty with Fuel Tank Re-Installed	A-28
57	2003 Jeep Liberty with Fuel Tank Re-Installed	A-29
58	2003 Jeep Liberty with Fuel Tank Re-Installed	A-29
59	2003 Jeep Liberty with Fuel Tank and FTEP Re-Installed	A-30
60	2003 Jeep Liberty with Fuel Tank and FTEP Re-Installed	A-30
61	2003 Jeep Liberty with Fuel Tank and FTEP Re-Installed	A-31
62	2003 Jeep Liberty with Fuel Tank and FTEP Re-Installed	A-31
63	2003 Jeep Liberty with Fuel Tank and FTEP Re-Installed	A-32
64	2003 Jeep Liberty with Fuel Tank and FTEP Re-Installed	A-32
65	2003 Jeep Liberty with Fuel Tank and FTEP Re-Installed	A-33
66	2003 Jeep Liberty with Fuel Tank and FTEP Re-Installed	A-33

## LIST OF PHOTOGRAPHS

<u>Figure</u>		<u>Page</u>
67	Pre-Test 2003 Jeep Liberty and 2002 Cadillac Seville SLS	A-34
68	Pre-Test 2003 Jeep Liberty and 2002 Cadillac Seville SLS	A-34
69	Pre-Test 2003 Jeep Liberty and 2002 Cadillac Seville SLS	A-35
70	Pre-Test 2003 Jeep Liberty and 2002 Cadillac Seville SLS	A-35
71	Pre-Test 2003 Jeep Liberty and 2002 Cadillac Seville SLS	A-36
72	Pre-Test 2003 Jeep Liberty and 2002 Cadillac Seville SLS	A-36
73	Pre-Test 2003 Jeep Liberty and 2002 Cadillac Seville SLS	A-37
74	Pre-Test 2003 Jeep Liberty and 2002 Cadillac Seville SLS	A-37
75	Pre-Test 2003 Jeep Liberty	A-38
76	Post-Test 2003 Jeep Liberty	A-38
77	Pre-Test 2003 Jeep Liberty	A-39
78	Post-Test 2003 Jeep Liberty	A-39
79	Pre-Test 2003 Jeep Liberty	A-40
80	Post-Test 2003 Jeep Liberty	A-40
81	Pre-Test 2003 Jeep Liberty	A-41
82	Post-Test 2003 Jeep Liberty	A-41
83	Pre-Test 2003 Jeep Liberty	A-42
84	Post-Test 2003 Jeep Liberty	A-42
85	Pre-Test 2003 Jeep Liberty	A-43
86	Post-Test 2003 Jeep Liberty	A-43
87	Pre-Test 2003 Jeep Liberty	A-44
88	Post-Test 2003 Jeep Liberty	A-44
89	Pre-Test 2003 Jeep Liberty	A-45
90	Post-Test 2003 Jeep Liberty	A-45
91	Pre-Test 2003 Jeep Liberty	A-46
92	Post-Test 2003 Jeep Liberty	A-46
93	Pre-Test 2003 Jeep Liberty	A-47
94	Post-Test 2003 Jeep Liberty	A-47
95	Pre-Test 2003 Jeep Liberty	A-48
96	Post-Test 2003 Jeep Liberty	A-48
97	Pre-Test 2003 Jeep Liberty	A-49
98	Post-Test 2003 Jeep Liberty	A-49
99	Pre-Test 2003 Jeep Liberty	A-50

## LIST OF PHOTOGRAPHS

<u>Figure</u>		<u>Page</u>
100	Post-Test 2003 Jeep Liberty	A-50
101	Post-Test 2003 Jeep Liberty	A-51
102	Post-Test 2003 Jeep Liberty	A-51
103	Post-Test 2003 Jeep Liberty	A-52
104	Post-Test 2003 Jeep Liberty	A-52
105	Post-Test 2003 Jeep Liberty	A-53
106	Post-Test 2003 Jeep Liberty	A-53
107	Post-Test Fuel Tank Inspection	A-54
108	Post-Test Fuel Tank Inspection	A-54
109	Post-Test Fuel Tank Inspection	A-55
110	Post-Test Fuel Tank Inspection	A-55
111	Post-Test Fuel Tank Inspection	A-56
112	Post-Test Fuel Tank Inspection	A-56
113	Post-Test Fuel Tank Inspection	A-57
114	Post-Test Fuel Tank Inspection	A-57
115	Post-Test Fuel Tank Inspection	A-58
116	Post-Test Fuel Tank Inspection	A-58
117	Post-Test Fuel Tank Inspection	A-59
118	Post-Test Fuel Tank Inspection	A-59
119	Post-Test Fuel Tank Inspection	A-60
120	Post-Test Fuel Tank Inspection	A-60
121	Post-Test Fuel Tank Inspection	A-61
122	Post-Test Fuel Tank Inspection	A-61
123	Post-Test Fuel Tank Inspection	A-62
124	Post-Test Fuel Tank Inspection	A-62
125	Post-Test Fuel Tank Inspection	A-63
126	Post-Test Fuel Tank Inspection	A-63
127	Post-Test Fuel Tank Inspection	A-64
128	Post-Test Fuel Tank Inspection	A-64
129	Post-Test Fuel Tank Inspection	A-65
130	Post-Test Fuel Tank Inspection	A-65
131	Post-Test Fuel Tank Inspection	A-66

## LIST OF PHOTOGRAPHS

<u>Figure</u>		<u>Page</u>
132	Post-Test Fuel Tank Inspection	A-66
133	Post-Test Fuel Tank Inspection	A-67
134	Post-Test Fuel Tank Inspection	A-67
135	Post-Test Fuel Tank Inspection	A-68
136	Post-Test Fuel Tank Inspection	A-68
137	Post-Test Fuel Tank Inspection	A-69
138	Post-Test Fuel Tank Inspection	A-69
139	Post-Test Fuel Tank Inspection	A-70
140	Post-Test Fuel Tank Inspection	A-70
141	Post-Test Fuel Tank Inspection	A-71
142	Post-Test Fuel Tank Inspection	A-71
143	Post-Test Fuel Tank Inspection	A-72
144	Post-Test Fuel Tank Inspection	A-72
145	Post-Test Fuel Tank Inspection	A-73
146	Post-Test Door Opening	A-73
147	Post-Test Door Opening	A-74
148	Post-Test Door Opening	A-74
149	Post-Test Door Opening	A-75



FIGURE 1. 2003 Jeep Liberty as Received View



FIGURE 2. 2003 Jeep Liberty as Received View

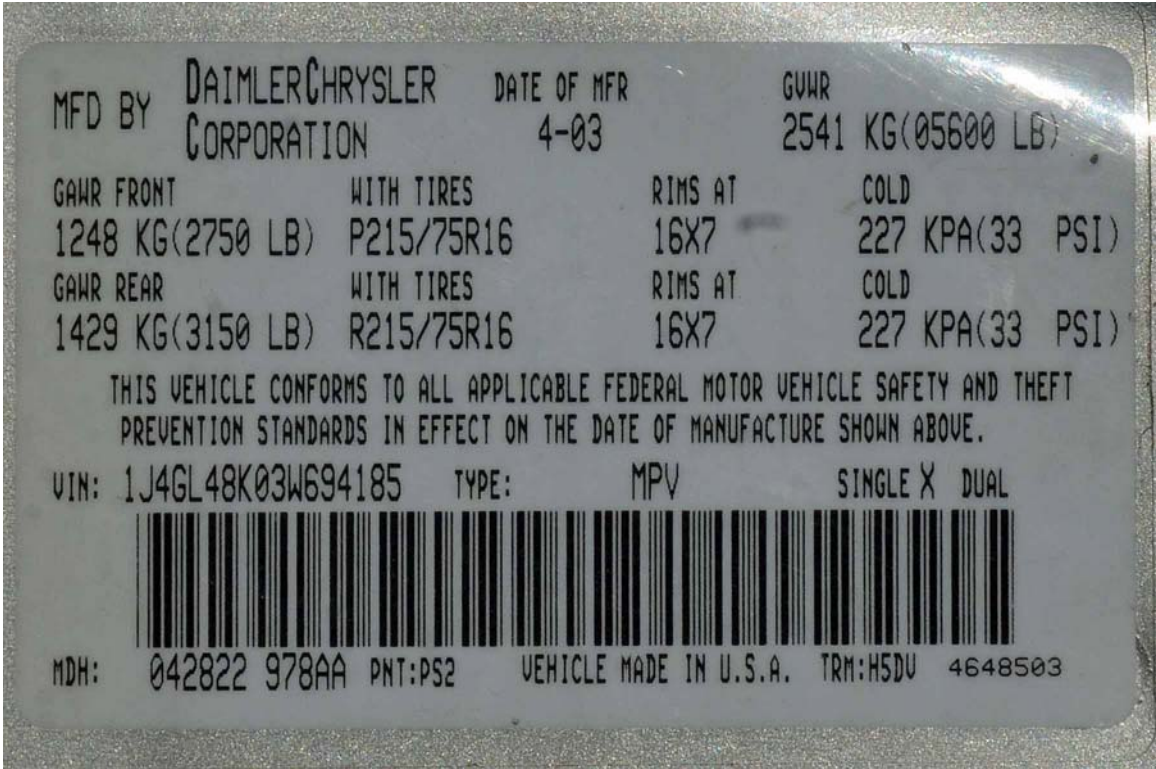

FIGURE 3. 2003 Jeep Liberty Vehicle Manufacturer's Label



FIGURE 4. 2002 Cadillac Seville SLS as Received View



FIGURE 5. 2002 Cadillac Seville SLS as Received View

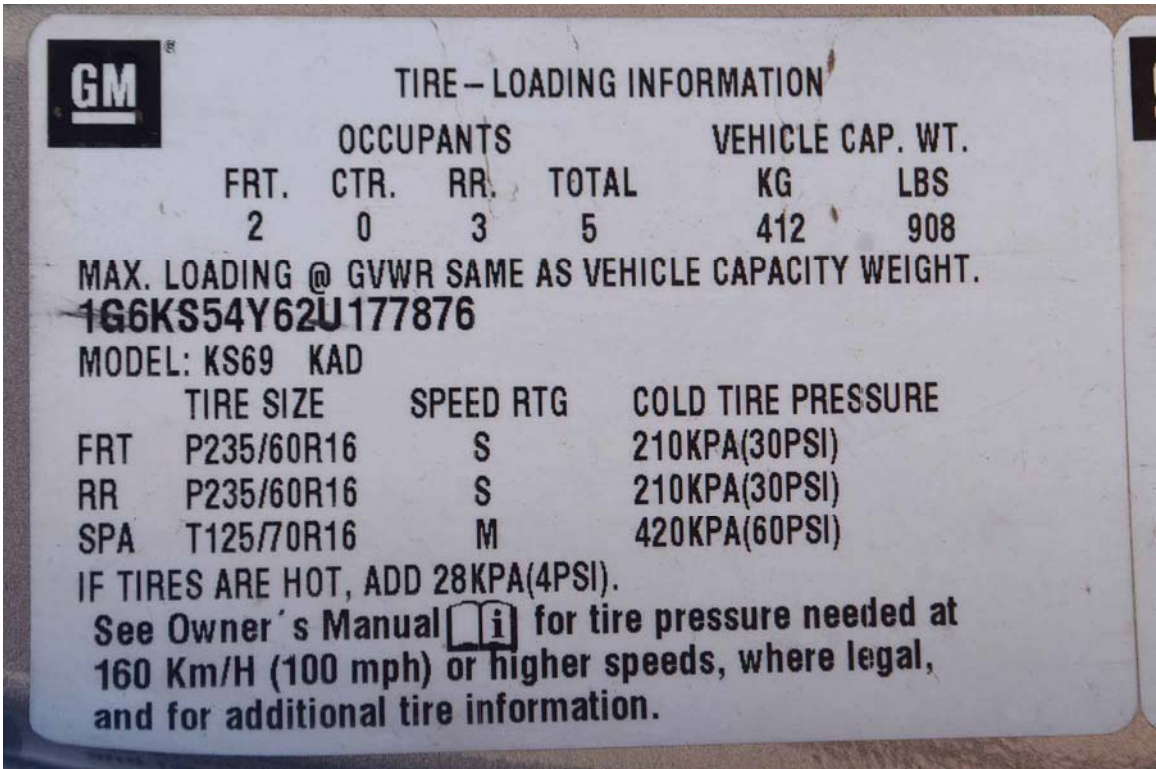

FIGURE 6. 2002 Cadillac Seville SLS Vehicle Manufacturer's Label





FIGURE 7. Pre-Test 2003 Jeep Liberty Fuel Tank



FIGURE 8. Pre-Test 2003 Jeep Liberty Fuel Tank



FIGURE 9. Pre-Test 2003 Jeep Liberty Fuel Tank



FIGURE 10. Pre-Test 2003 Jeep Liberty Fuel Tank



FIGURE 11. Pre-Test 2003 Jeep Liberty Fuel Tank



FIGURE 12. Pre-Test 2003 Jeep Liberty Fuel Tank



FIGURE 13. Pre-Test 2003 Jeep Liberty Fuel Tank



FIGURE 14. Pre-Test 2003 Jeep Liberty Fuel Tank



FIGURE 15. Pre-Test 2003 Jeep Liberty Fuel Tank



FIGURE 16. Pre-Test 2003 Jeep Liberty Fuel Tank



FIGURE 17. Pre-Test 2003 Jeep Liberty Fuel Tank



FIGURE 18. Pre-Test 2003 Jeep Liberty Fuel Tank



FIGURE 19. 2003 Jeep Liberty Fuel Tank



FIGURE 20. 2003 Jeep Liberty Fuel Tank



FIGURE 21. 2003 Jeep Liberty Fuel Tank



FIGURE 22. 2003 Jeep Liberty Fuel Tank





FIGURE 23. 2003 Jeep Liberty Fuel Tank



FIGURE 24. 2003 Jeep Liberty Fuel Tank Removed



FIGURE 25. 2003 Jeep Liberty Fuel Tank Removed



FIGURE 26. 2003 Jeep Liberty Fuel Tank Removed



FIGURE 27. 2003 Jeep Liberty with Fuel Tank Reinstalled



FIGURE 28. 2003 Jeep Liberty with Fuel Tank Reinstalled



FIGURE 29. 2003 Jeep Liberty with Fuel Tank Reinstalled



FIGURE 30. 2003 Jeep Liberty with Fuel Tank Reinstalled



FIGURE 31. 2003 Jeep Liberty with Fuel Tank Reinstalled



FIGURE 32. 2003 Jeep Liberty with Fuel Tank Reinstalled



FIGURE 33. 2003 Jeep Liberty with SFK Manufacturing Model JP-4002 Skid Plate Installed



FIGURE 34. 2003 Jeep Liberty with SFK Manufacturing Model JP-4002 Skid Plate Installed



FIGURE 35. 2003 Jeep Liberty with SFK Manufacturing Model JP-4002 Skid Plate Installed



FIGURE 36. 2003 Jeep Liberty with SFK Manufacturing Model JP-4002 Skid Plate Installed



FIGURE 37. 2003 Jeep Liberty with SFK Manufacturing Model JP-4002 Skid Plate Installed



FIGURE 38. 2003 Jeep Liberty with SFK Manufacturing Model JP-4002 Skid Plate Installed





FIGURE 39. 2003 Jeep Liberty with Fuel Tank Removed

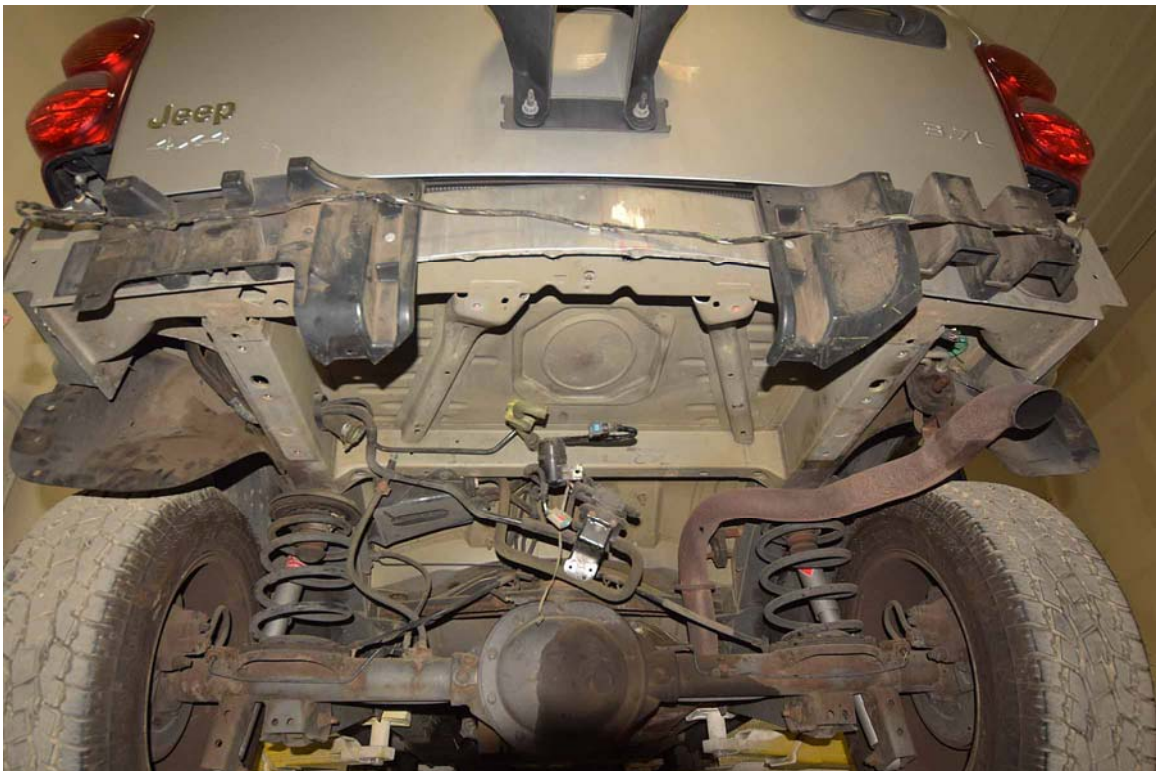

FIGURE 40. 2003 Jeep Liberty with Fuel Tank Removed



FIGURE 41. 2003 Jeep Liberty with Fuel Tank Removed

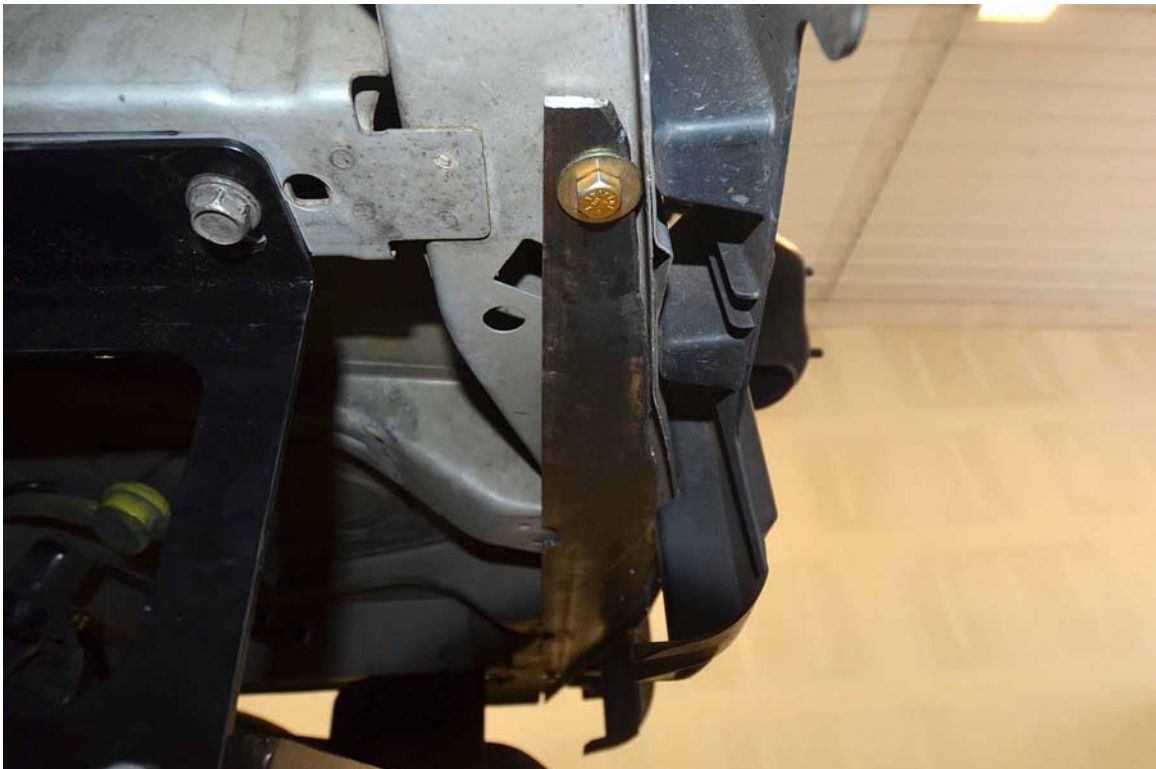

FIGURE 42. 2003 Jeep Liberty Fuel Tank Encapsulation Prototype Design Process



FIGURE 43. 2003 Jeep Liberty Fuel Tank Encapsulation Prototype Design Process

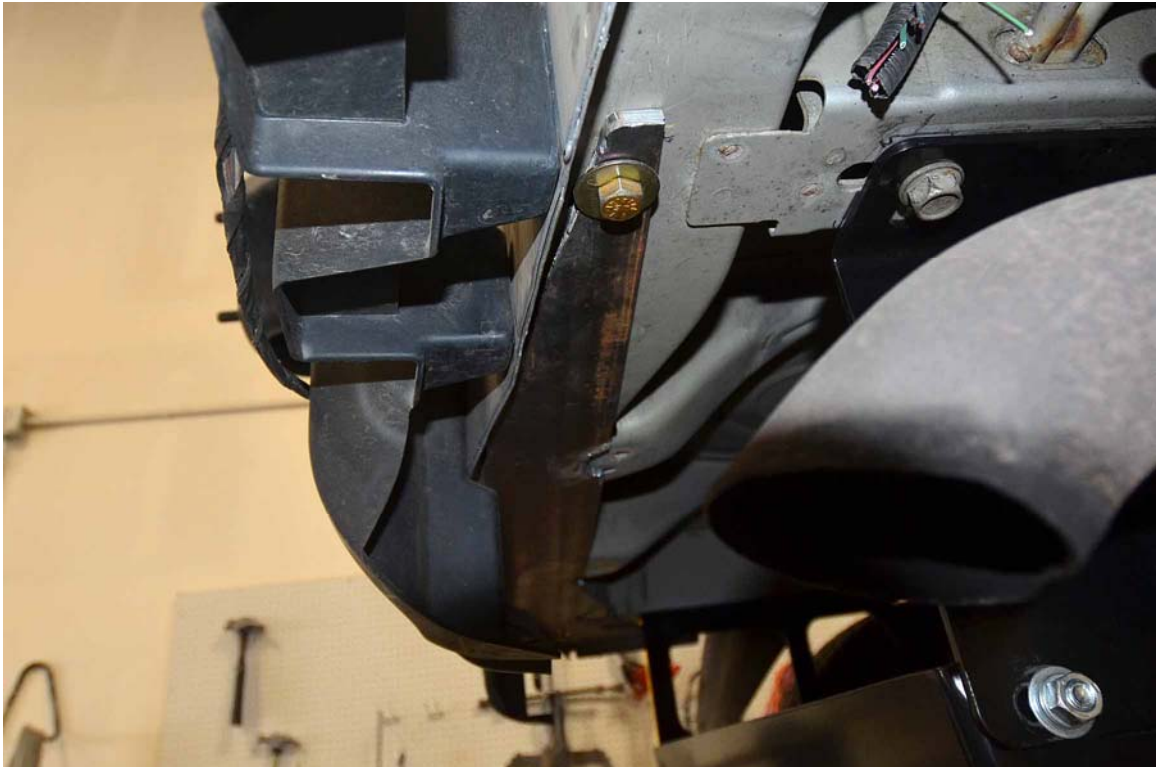

FIGURE 44. 2003 Jeep Liberty Fuel Tank Encapsulation Prototype Design Process



FIGURE 45. 2003 Jeep Liberty Fuel Tank Encapsulation Prototype Design Process



FIGURE 46. 2003 Jeep Liberty Fuel Tank Encapsulation Prototype Design Process



FIGURE 47. 2003 Jeep Liberty Fuel Tank Encapsulation Prototype Design Process



FIGURE 48. 2003 Jeep Liberty Fuel Tank Encapsulation Prototype Design Process



FIGURE 49. 2003 Jeep Liberty Fuel Tank Encapsulation Prototype Design Process



FIGURE 50. 2003 Jeep Liberty Fuel Tank Encapsulation Prototype Design Process



FIGURE 51. 2003 Jeep Liberty Fuel Tank Encapsulation Prototype Design Process



FIGURE 52. 2003 Jeep Liberty Fuel Tank Encapsulation Prototype Design Process



FIGURE 53. 2003 Jeep Liberty Fuel Tank Encapsulation Prototype Design Process Showing 1/2" Plate



FIGURE 54. 2003 Jeep Liberty with Fuel Tank Re-Installed





FIGURE 55. 2003 Jeep Liberty with Fuel Tank Re-Installed

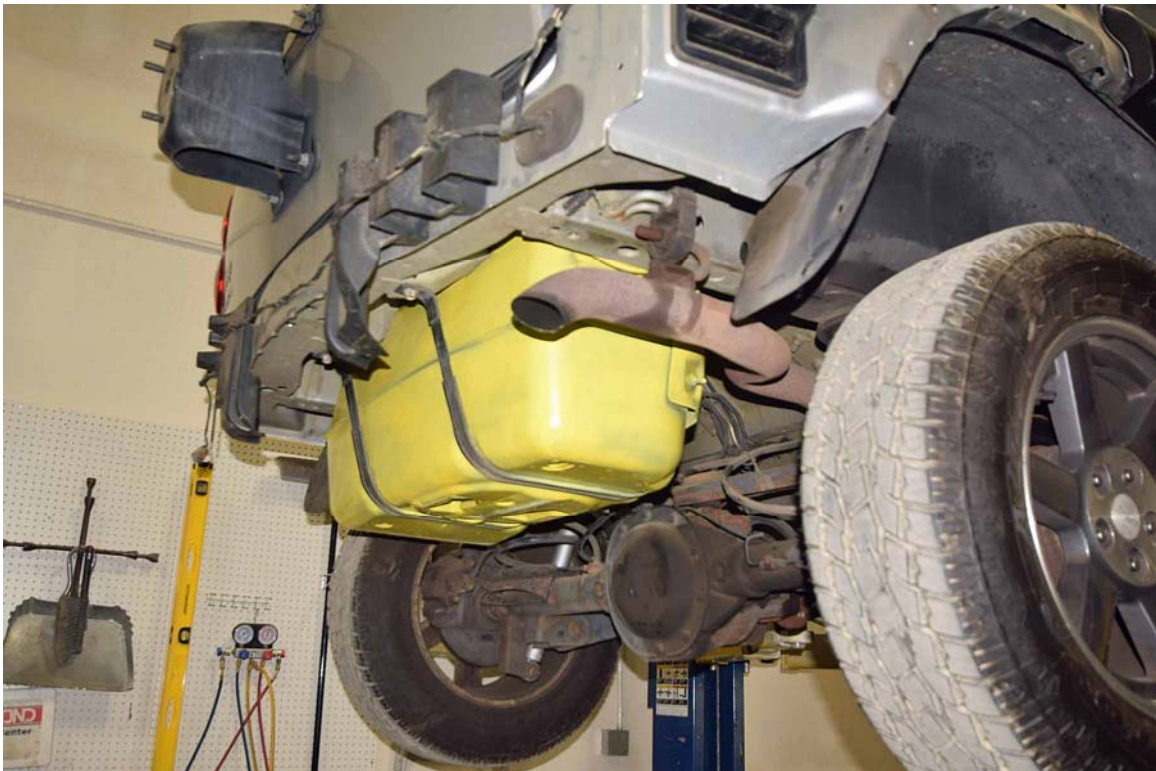

FIGURE 56. 2003 Jeep Liberty with Fuel Tank Re-Installed



FIGURE 57. 2003 Jeep Liberty with Fuel Tank Re-Installed



FIGURE 58. 2003 Jeep Liberty with Fuel Tank Re-Installed



FIGURE 59. 2003 Jeep Liberty with Fuel Tank and FTEP Re-Installed



FIGURE 60. 2003 Jeep Liberty with Fuel Tank and FTEP Re-Installed



FIGURE 61. 2003 Jeep Liberty with Fuel Tank and FTEP Re-Installed



FIGURE 62. 2003 Jeep Liberty with Fuel Tank and FTEP Re-Installed



FIGURE 63. 2003 Jeep Liberty with Fuel Tank and FTEP Re-Installed



FIGURE 64. 2003 Jeep Liberty with Fuel Tank and FTEP Re-Installed



FIGURE 65. 2003 Jeep Liberty with Fuel Tank and FTEP Re-Installed



FIGURE 66. 2003 Jeep Liberty with Fuel Tank and FTEP Re-Installed



FIGURE 67. Pre-Test 2003 Jeep Liberty and 2002 Cadillac Seville SLS



FIGURE 68. Pre-Test 2003 Jeep Liberty and 2002 Cadillac Seville SLS



FIGURE 69. Pre-Test 2003 Jeep Liberty and 2002 Cadillac Seville SLS



FIGURE 70. Pre-Test 2003 Jeep Liberty and 2002 Cadillac Seville SLS





FIGURE 71. Pre-Test 2003 Jeep Liberty and 2002 Cadillac Seville SLS



FIGURE 72. Pre-Test 2003 Jeep Liberty and 2002 Cadillac Seville SLS

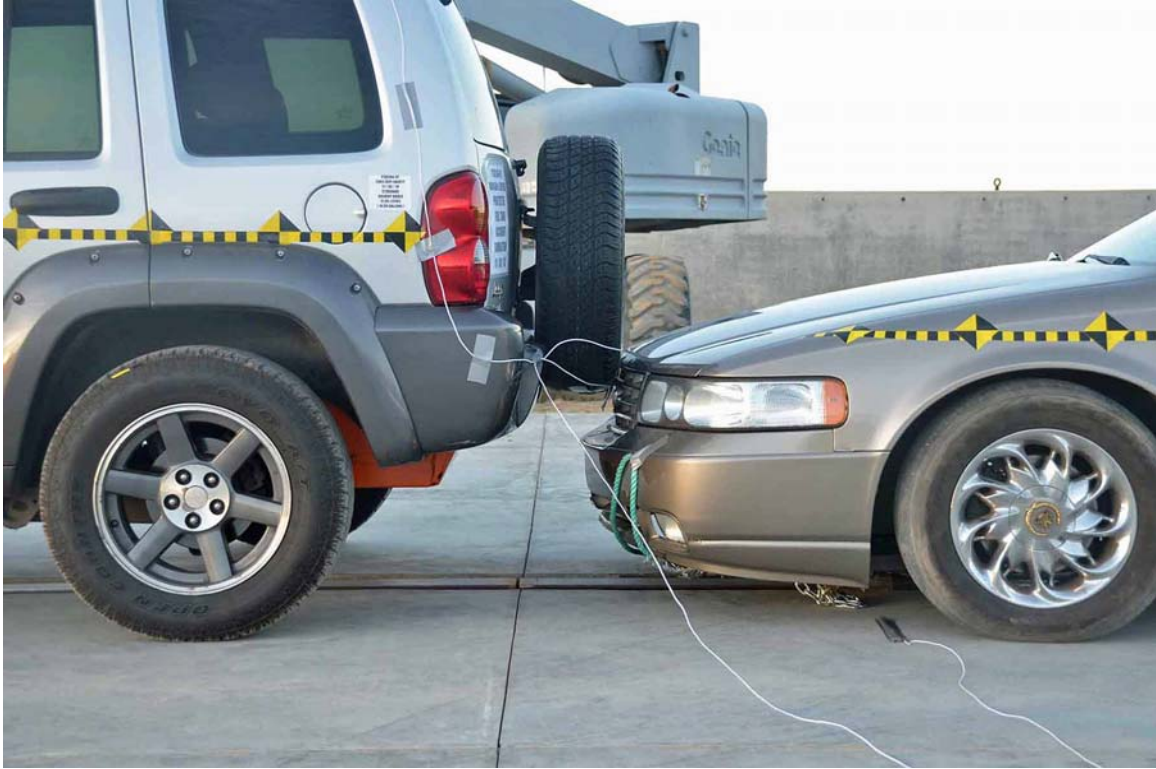

FIGURE 73. Pre-Test 2003 Jeep Liberty and 2002 Cadillac Seville SLS



FIGURE 74. Pre-Test 2003 Jeep Liberty and 2002 Cadillac Seville SLS



FIGURE 75. Pre-Test 2003 Jeep Liberty



FIGURE 76. Post-Test 2003 Jeep Liberty



FIGURE 77. Pre-Test 2003 Jeep Liberty



FIGURE 78. Post-Test 2003 Jeep Liberty



FIGURE 79. Pre-Test 2003 Jeep Liberty



FIGURE 80. Post-Test 2003 Jeep Liberty



FIGURE 81. Pre-Test 2003 Jeep Liberty



FIGURE 82. Post-Test 2003 Jeep Liberty



FIGURE 83. Pre-Test 2003 Jeep Liberty



FIGURE 84. Post-Test 2003 Jeep Liberty



FIGURE 85. Pre-Test 2003 Jeep Liberty



FIGURE 86. Post-Test 2003 Jeep Liberty





FIGURE 87. Pre-Test 2003 Jeep Liberty



FIGURE 88. Post-Test 2003 Jeep Liberty



FIGURE 89. Pre-Test 2003 Jeep Liberty



FIGURE 90. Post-Test 2003 Jeep Liberty



FIGURE 91. Pre-Test 2003 Jeep Liberty



FIGURE 92. Post-Test 2003 Jeep Liberty



FIGURE 93. Pre-Test 2003 Jeep Liberty



FIGURE 94. Post-Test 2003 Jeep Liberty



FIGURE 95. Pre-Test 2003 Jeep Liberty



FIGURE 96. Post-Test 2003 Jeep Liberty



FIGURE 97. Pre-Test 2003 Jeep Liberty

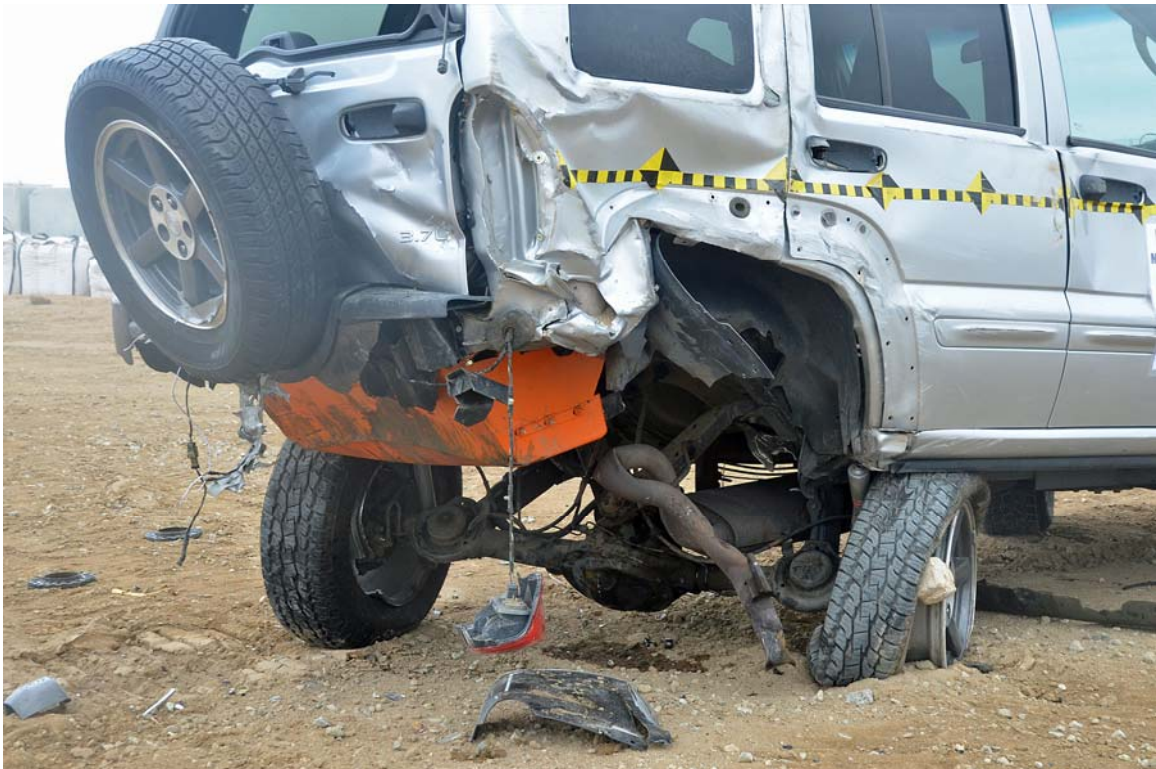

FIGURE 98. Post-Test 2003 Jeep Liberty



FIGURE 99. Pre-Test 2003 Jeep Liberty



FIGURE 100. Post-Test 2003 Jeep Liberty



FIGURE 101. Post-Test 2003 Jeep Liberty



FIGURE 102. Post-Test 2003 Jeep Liberty





FIGURE 103. Post-Test 2003 Jeep Liberty



FIGURE 104. Post-Test 2003 Jeep Liberty



FIGURE 105. Post-Test 2003 Jeep Liberty



FIGURE 106. Post-Test 2003 Jeep Liberty



FIGURE 107. Post-Test Fuel Tank Inspection



FIGURE 108. Post-Test Fuel Tank Inspection



FIGURE 109. Post-Test Fuel Tank Inspection



FIGURE 110. Post-Test Fuel Tank Inspection



FIGURE 111. Post-Test Fuel Tank Inspection



FIGURE 112. Pre-Test Fuel Tank Inspection



FIGURE 113. Post-Test Fuel Tank Inspection



FIGURE 114. Post-Test Fuel Tank Inspection



FIGURE 115. Post-Test Fuel Tank Inspection



FIGURE 116. Post-Test Fuel Tank Inspection



FIGURE 117. Post-Test Fuel Tank Inspection



FIGURE 118. Post-Test Fuel Tank Inspection





FIGURE 119. Post-Test Fuel Tank Inspection



FIGURE 120. Post-Test Fuel Tank Inspection



FIGURE 121. Post-Test Fuel Tank Inspection



FIGURE 122. Post-Test Fuel Tank Inspection



FIGURE 123. Post-Test Fuel Tank Inspection



FIGURE 124. Post-Test Fuel Tank Inspection



FIGURE 125. Post-Test Fuel Tank Inspection



FIGURE 126. Post-Test Fuel Tank Inspection



FIGURE 127. Post-Test Fuel Tank Inspection



FIGURE 128. Post-Test Fuel Tank Inspection



FIGURE 129. Post-Test Fuel Tank Inspection



FIGURE 130. Post-Test Fuel Tank Inspection



FIGURE 131. Post-Test Fuel Tank Inspection



FIGURE 132. Post-Test Fuel Tank Inspection



FIGURE 133. Post-Test Fuel Tank Inspection



FIGURE 134. Post-Test Fuel Tank Inspection





FIGURE 135. Post-Test Fuel Tank Inspection



FIGURE 136. Post-Test Fuel Tank Inspection



FIGURE 137. Post-Test Fuel Tank Inspection



FIGURE 138. Post-Test Fuel Tank Inspection



FIGURE 139. Post-Test Fuel Tank Inspection



FIGURE 140. Post-Test Fuel Tank Inspection



FIGURE 141. Post-Test Fuel Tank Inspection



FIGURE 142. Post-Test Fuel Tank Inspection



FIGURE 143. Post-Test Fuel Tank Inspection



FIGURE 144. Post-Test Fuel Tank Inspection



FIGURE 145. Post-Test Fuel Tank Inspection

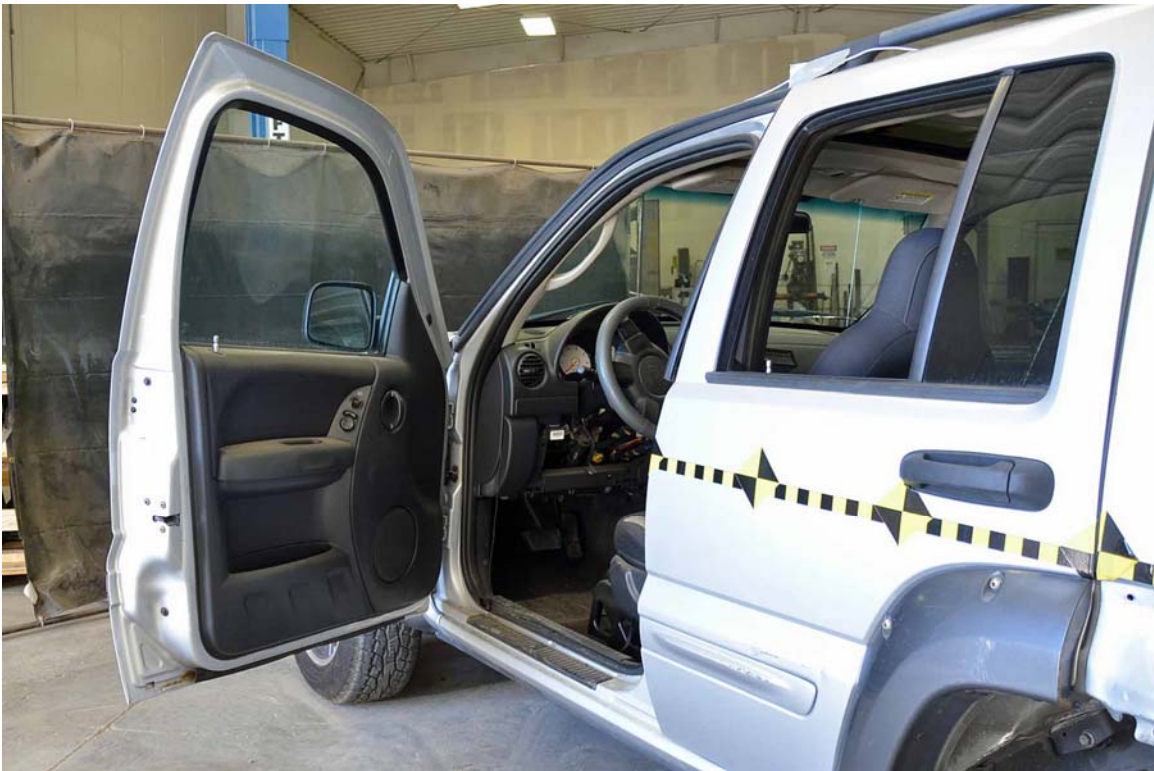

FIGURE 146. Post-Test Door Opening



FIGURE 147. Post-Test Door Opening



FIGURE 148. Post-Test Door Opening



FIGURE 149. Post-Test Door Opening



# EXHIBIT 4

30 April 2019

Mr. Courtney E. Morgan  
Law Offices of Courtney Morgan PLLC  
Suite 260  
3200 Greenfield Road  
Dearborn, MI 48120-1802  
313-961-0130  
[cmorgan@courtneymorganlaw.com](mailto:cmorgan@courtneymorganlaw.com)

**Subject: Expert Report - White / Campbell versus FCA, et al**

Content : 5 pages

Addendum to Exhibit 3:

Applus IDIADA KARCO Engineering, LLC., report number TR-P38306-01-A.

**Expert's General Comments and Issues Summary**

**Applus IDIADA KARCO Engineering, LLC – Test Report Number : TR-P38306-01-NC**

Cover Page	Photograph selected as pre-test representation of rear <b>underride</b> collision geometry between rear bumper / structure of 2003 Jeep Liberty (KJ-Body model) versus front bumper / structure of 2002 Cadillac Seville (G-Body model)
Page i	no comments at this time
Page ii	Additional photographs added in support of Page 3 Comment 1, and Page 6 below. "Rear bumper" revised to reflect extended componentry / design of rear structure, fascia, etc. of KJ. Transverse rail is the structural portion of rear bumper <b>system</b> .
Page iii	no comments at this time
Page 1	no comments at this time
Page 2	<p><i>Paragraph 1:</i> Plaintiff requested impact speed of 75 miles per hour; equipment parameters resulted in actual impact speed of 73.84 MPH, a 1.26 MPH variance.</p> <p><i>Paragraph 2:</i> Short piece of ½" plate was the result of steel plate stock availability/convenience; original SFK-JP-4002 skid plate does not include bolt attachment at that location of KJ chassis. Report verbiage regarding prototype build exception (½ " versus 3/16" plate) and Photo #53 were added per expert's 'full disclosure' practice; please see Exhibit 3, photograph #53. Had no discernable effect on FTEP crash performance.</p> <p><i>Paragraph 3:</i> 2.25" lowering of 2002 Cadillac Seville specified by other plaintiff's experts as typical of chassis response to emergency braking during real world accident sequence; so-called "nose-dive" effect.</p>
Page 3 Comment 1	<p><i>" . . . Stoddard solvent was present and drops of solvent were observed on the ground near the rear end of the target vehicle."</i></p> <p>Undersigned was first-to-arrive at the Jeep KJ target vehicle rest location (post crash test), and did not observe any Stoddard solvent on the ground. Karco engineers and undersigned did not observe any Stoddard <b>trail</b> from the crash platform all the way to rest location. Observed and noted by all present were droplets of <u>black</u> differential oil, not <u>purple</u> Stoddard droplets. Addition of photographs (per Page ii comment above) was requested by undersigned to confirm that Karco photos do not show Stoddard droplets, but do show droplets of differential oil. Please see Exhibit 3 photographs #101, #102, and #104. Undersigned conducted a complete and immediate <b>tactile</b> inspection post-test of the FTEP and all adjacent underbody areas; this confirmed zero moisture / zero Stoddard present; completely dry condition.</p> <p>Photos taken by the undersigned, <b>immediately</b> at the conclusion of crash test, <b>also</b> do not show droplets of purple colored Stoddard; samples of the latter time-stamped photos are attached below.</p>

**Expert's General Comments and Issues Summary**

**Applus IDIADA KARCO Engineering, LLC – Test Report Number : TR-P38306-01-NC**

con't

Page 3 Comment 2	Undersigned agrees with, “. . . the odor of Stoddard solvent was present.”
Page 3 Comment 3	Undersigned agrees with, “The amount of solvent observed was immeasurable..”
Page 3 Comment 4	<p>Page 3 paragraph 2, the undersigned was present throughout the post-test inspection, conducted on December 21, 2018.</p> <p>Report verbiage, “Upon removal of the FTEP and the fuel tank from the vehicle, a plastic output nipple on the top of the fuel tank was found cracked.”</p> <p>Two possibilities for this condition were proposed/reviewed:</p> <p>(1) Minor crack occurred during the crash test, provoking attention to an additional Jeep Liberty KJ issue.</p> <p>(2) Initial inspection of the fuel tank and pump assembly confirmed that these 16 year old components had never been removed/serviced.</p> <p>During a two-fold Karco removal/re-install of the fuel tank, the fuel pump access panel was not utilized. Karco technicians later admitted strain/difficulty with fuel pump liquid/electrical lines. It is possible that minor stress crack in the <b>plastic</b> fuel outlet nipple occurred during this difficulty. Crack is shown in report photos #131, #132, #133, #134, #135, #136, #137, and #138, which were taken at the post-crash inspection. It is possible that the crack did not occur during the crash test. Competitive use of <b>steel</b> fuel pump assembly, including <b>steel</b> nipples, such as used by Ford on vehicles such as the Crown Victoria, would have eliminated this additional KJ issue..</p> <p>The minor fumes that were present post-test appeared to originate from top of tank, where no crash ignition sources are present. No other tank surface had Stoddard staining. Photographs of Fuel Pump Assembly Access Panel and minor top of tank Stoddard trace-staining attached below.</p>
Pages 4/5	no comments at this time
Page 6	Please see ‘Page 3 – Comment 1’ above.
Appendix A	Addition of Photographs #146, #147, #148, and #149 affirm report page 3 words relating to Jeep KJ door operations post-crash test.

**Expert's General Comments and Issues Summary**

**Applus IDIADA KARCO Engineering, LLC – Test Report Number : TR-P38306-01-NC**

Following photographs relate to Page 3 – Comment 1, and Page 6 comment above:



**Expert's General Comments and Issues Summary**

**Applus IDIADA KARCO Engineering, LLC – Test Report Number : TR-P38306-01-NC**

Page 3 – Comment 4 above, fuel pump access panel:



Page 3 – Comment 4 above, Stoddard trace-staining restricted to top-of-tank only, post crash test inspection confirmed that no other tank surface location had staining and were completely dry/intact:

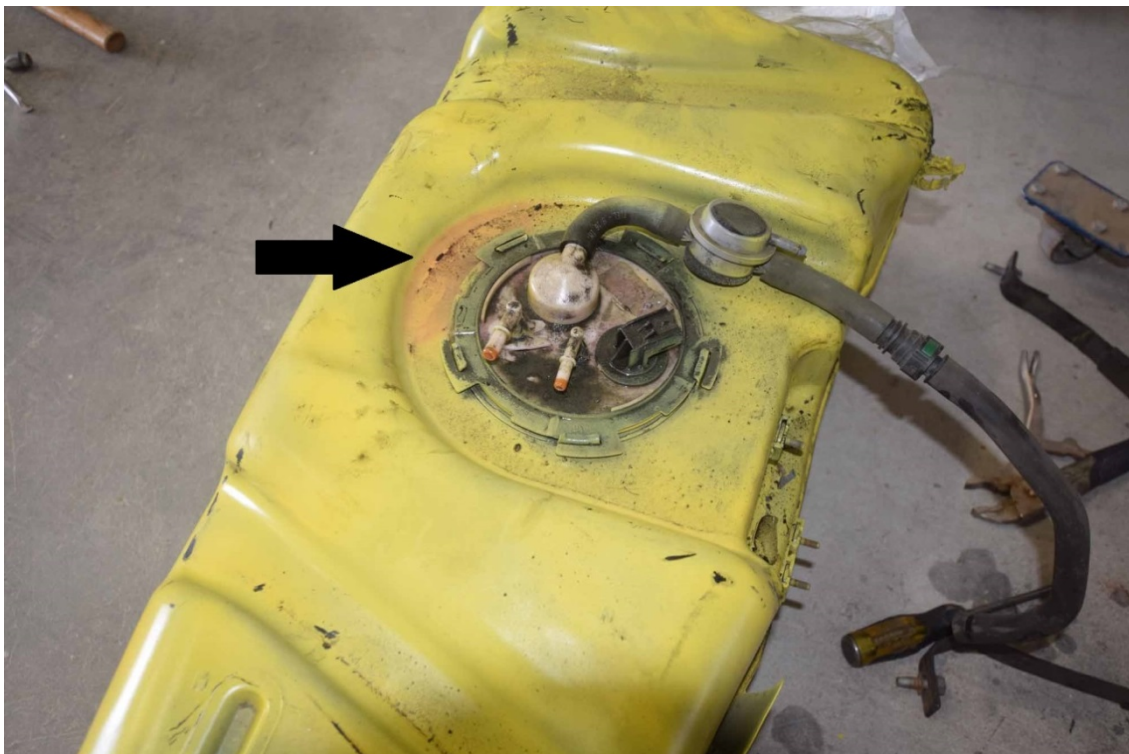

**Expert's General Comments and Issues Summary**  
**Applus IDIADA KARCO Engineering, LLC – Test Report Number : TR-P38306-01-NC**

The following photograph was taken on November 11, 2014:



Had the 2003 Jeep Liberty driven by Ms. Kayla White been equipped with the FTEP crashworthiness system as tested under Exhibit 3, **the probability of the above conflagration approaches zero.**



Although an item for further development, the estimated OEM cost of an FTEP derived crashworthiness system is no more than \$40 - \$50.

# EXHIBIT 5

30 April 2019

Mr. Courtney E. Morgan  
Law Offices of Courtney Morgan PLLC  
Suite 260  
3200 Greenfield Road  
Dearborn, MI 48120-1802  
313-961-0130  
[cmorgan@courtneymorganlaw.com](mailto:cmorgan@courtneymorganlaw.com)

**Subject: Expert Report - White / Campbell versus FCA, et al**

Content : 7 Pages

Pictorial presentation/review of the mock-up, fabrication/construction, and installation process of the FTEP onto a typical Jeep Liberty KJ

Pictorial presentation/review of the mock-up, fabrication/construction, and installation process of the FTEP onto a typical Jeep Liberty KJ

A brief pictorial presentation/review of the mock-up, fabrication/construction, and installation process of the FTEP onto a 2003 Jeep Liberty KJ, in preparation for a rear-end crash test with a 2002 Cadillac Seville, which impacted the test KJ at 73.4 miles per hour:

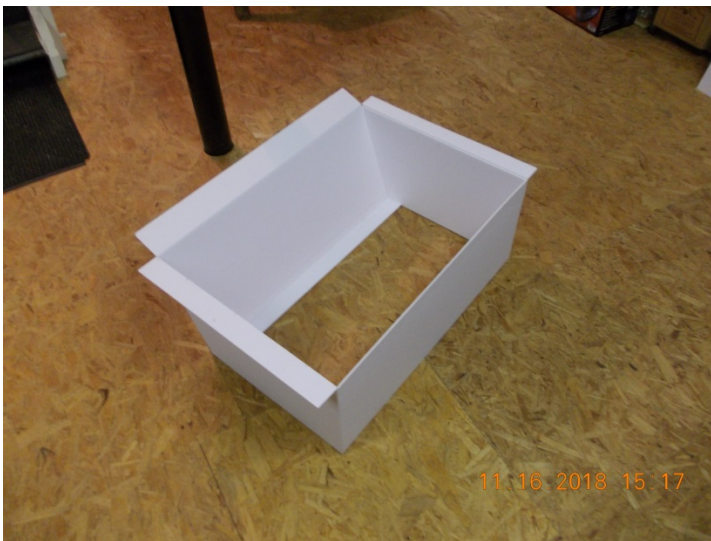
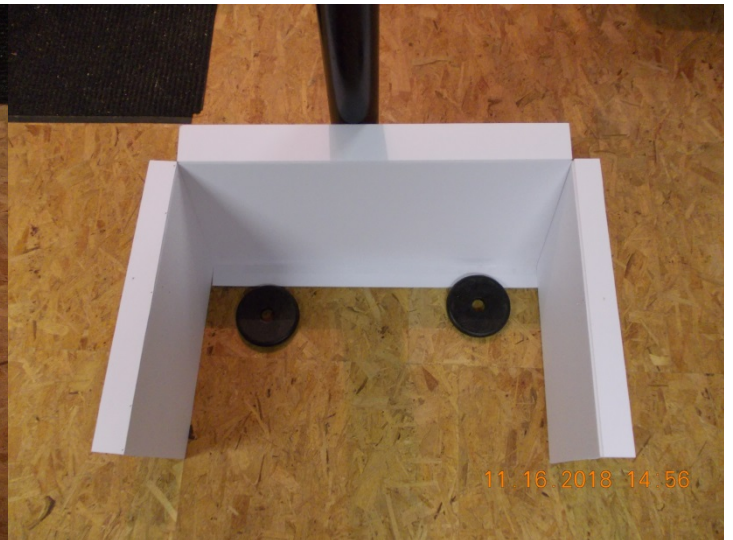
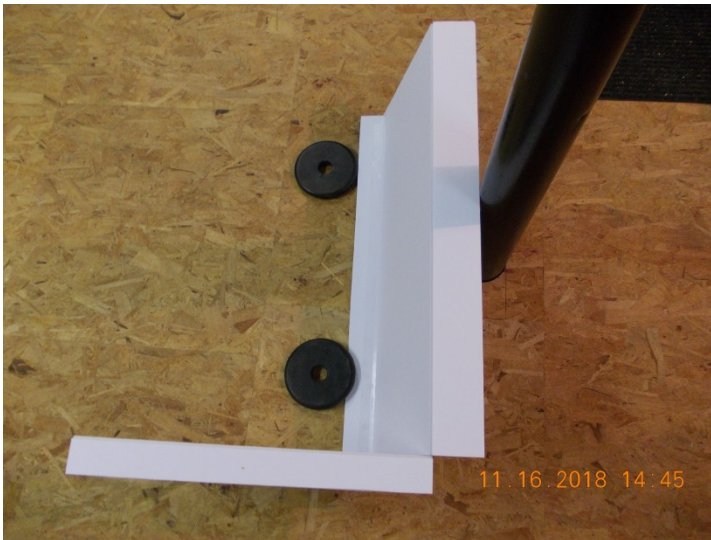



Pictorial presentation/review of the mock-up, fabrication/construction, and installation process of the FTEP onto a typical Jeep Liberty KJ



Pictorial presentation/review of the mock-up, fabrication/construction, and installation process of the FTEP onto a typical Jeep Liberty KJ



Pictorial presentation/review of the mock-up, fabrication/construction, and installation process of the FTEP onto a typical Jeep Liberty KJ

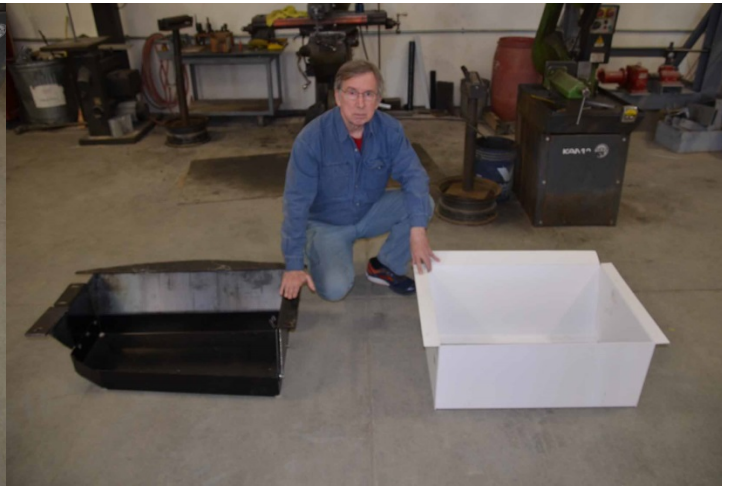

Pictorial presentation/review of the mock-up, fabrication/construction, and installation process of the FTEP onto a typical Jeep Liberty KJ



Pictorial presentation/review of the mock-up, fabrication/construction, and installation process of the FTEP onto a typical Jeep Liberty KJ



Pictorial presentation/review of the mock-up, fabrication/construction, and installation process of the FTEP onto a typical Jeep Liberty KJ



# END OF DOCUMENT

30 April 2019

Mr. Courtney E. Morgan  
Law Offices of Courtney Morgan PLLC  
Suite 260  
3200 Greenfield Road  
Dearborn, MI 48120-1802  
313-961-0130  
[cmorgan@courtneymorganlaw.com](mailto:cmorgan@courtneymorganlaw.com)

**Subject: Expert Report - White / Campbell versus FCA, et al**