



FedEx Express  
Customer Support Trace  
3875 Airways Boulevard  
Module H, 4th Floor  
Memphis, TN 38116

U.S. Mail: PO Box 727  
Memphis, TN 38194-4643  
Telephone: 901-369-3600

April 12, 2012

Dear Customer:

The following is the proof-of-delivery for tracking number **869449983946**.

---

**Delivery Information:**

---

|                       |              |                           |                           |
|-----------------------|--------------|---------------------------|---------------------------|
| <b>Status:</b>        | Delivered    | <b>Delivered to:</b>      | Receptionist/Front Desk   |
| <b>Signed for by:</b> | S.MCGINNIS   | <b>Delivery location:</b> | 1801 ROUTE 202<br>19342   |
| <b>Service type:</b>  | Standard Box | <b>Delivery date:</b>     | <b>Apr 12, 2012 10:43</b> |



---

**Shipping Information:**

---

|                         |              |                   |                |
|-------------------------|--------------|-------------------|----------------|
| <b>Tracking number:</b> | 869449983946 | <b>Ship date:</b> | Apr 11, 2012   |
|                         |              | <b>Weight:</b>    | 6.0 lbs/2.7 kg |

**Recipient:**

**MR DAVID KELLEHER**  
C/O DAVID DODGE CHRYSLER JEEP  
1801 ROUTE 202  
19342 US

**Reference**

**Shipper:**

**PAUL SHERIDAN**  
SHERIDAN, PAUL V  
22357 COLUMBIA ST  
481243431 US

NHTSA

Thank you for choosing FedEx Express.

FedEx Worldwide Customer Service  
1.800.GoFedEx 1.800.463.3339

22357 Columbia Street  
Dearborn, MI 48124-3431  
313-277-5095  
[pvs6@Cornell.edu](mailto:pvs6@Cornell.edu)

11 April 2012

VIA FEDEX AIRBILL #8694 – 4998 - 3946

Mr. David Kelleher, Chairman  
National Automobile Dealers Association  
c/o David Dodge Chrysler Jeep  
1801 Route 202  
Glen Mills, PA 19342  
610-358-5300 ext.1000  
dkelleher@drivedavid.com

**Subject: Automotive Product Defect Liability: Dealership Responsibility for Punitive Damages**  
**Reference 1: Jeep Grand Cherokee Fuel System Defect Investigation (NHTSA PE10 – 031)**  
**Reference 2: Voluntary Recall of Jeep Liberty Recall for Rust – 7 March 2012**

Dear Mr. Kelleher:

The Wall Street Journal [article](#) of 4 April 2012 entitled, “*Chrysler Got Legal Shield in Chapter 11*” regurgitated what is already well-known. The article did not provide recent incremental information that is of direct relevance to you as a highly-regarded dealer principal, as President of the [Chrysler Group LLC National Dealer Council](#), and as Chairman of the National Automobile Dealers Association (NADA).<sup>1</sup>

### **Purpose**

The purpose of sharing this recent, incremental information is manifold; all having high urgency:

1. Remind you of the safety defect presented by the fuel tank/system design of the 1993 thru 1998 (ZJ-Body) and 1999 thru 2004 (WJ-Body) Jeep Grand Cherokee vehicles which are under investigation by NHTSA,
2. As a dealer principal you should take the appropriate measures to inform existing or potential customers of #1 and the real world danger this defect continuously poses to their safety and well-being,
3. Make contact with appropriate Chrysler Group LLC management advising them of your knowledge/concerns about #1 while soliciting their expertise/advise on how to proceed, both in the context of your role as a dealer principal and as Chairman of the NADA.

As Chairman of NADA you may also wish to utilize official channels to discuss, with all member dealer principals, the far-reaching implications of the ruling documented in Tab A, which has not yet been publicly reported.

### **Hearing of 16 March 2012: Kline vs. Loman Auto Group, et al.**

I attended the 16 March 2012 hearing in the Superior Court of New Jersey in Morristown, NJ as expert for the plaintiff (Estate of Susan Kline). This hearing was the culmination of 1) the deposition of a former Chrysler dealership principal Mr. John Loman, 2) a voluminous filing by defendant’s counsel requesting that defendant Loman Auto Group (former Jeep dealership) be granted Partial Summary Judgment dismissing plaintiff’s punitive damages claim, and 3) an opposition filing/response by plaintiff’s counsel.

Many were perplexed that defense counsel would attempt this action.<sup>2</sup> His Honor denied defendant’s motion, and no further appeal is expected. The Honorable Judge David B. Rand order (Tab A) should be shared with all dealer principals. I am confident that they will agree that its portent is of greater urgency than that of rust . . .



**Jeep Grand Cherokee Fuel System Defect Investigation (NHTSA PE10 – 031) vs. Jeep Liberty Rust Recall**

I am compelled to impose upon you in a manner similar to that imposed upon four Congressmen. As requested of them in my letter of 13 February 2012<sup>3</sup>, please **take a moment to review Tab 1 of current Tab B.**

In that letter to Congress I stated the following conclusion:

*“I am confident that President Obama was not aware of the [Castaing testimony at the time he purchased his 2000 Jeep Grand Cherokee](#). Ostensibly speaking, your satisfaction with the notion that the post-collision fire injury/death risk of electric vehicles is ‘no greater than’ the 1993 through 2004 Jeep Grand Cherokee lacks proper perspective and priority.”*

I attended the 21 December 2011 deposition<sup>4</sup> of Mr. David Dillon, Chrysler Group LLC manager for Product Investigations. As you are aware, on 7 March 2012 Mr. Dillon announced the voluntary recall of the Jeep Liberty. This recall does not involve a NHTSA safety investigation. It involves the safety hazard posed by the long-term corrosion of the rear lower control arms. Not one accident. Not a single injury. Not one death is attributable to this rust recall. As part of long-standing routine communications, Mr. Dillon declared to the Chrysler dealers: *“Chrysler Group LLC is not is not aware of any accidents or injuries related to this issue.”* Can Mr. Dillon or NHTSA declare the same regarding defect investigation PE10-031 (Tab C)?

**The Horrific Fire Death of Four-Year-Old Remington Cole Walden (1999 Jeep Grand Cherokee)**

The details of the fire-death on 6 March 2012 of Remington are too horrific to document here. The WJ-Body<sup>5</sup>, the model that killed Remington, did not exhibit excessive corrosion. Like the ZJ-Body, the WJ-Body presents a notoriously defective fuel tank/system design.

But as Mr. Dillon is fully aware, on the same day that the rust recall was decided, the far higher priority of NHTSA investigation PE10-031 was, **once again**, horribly confirmed in the town of Bainbridge, Georgia (Tab D).

In real-world crash testing conducted by the Center for Auto Safety, the ZJ-Body and WJ-Body demonstrate instantaneous catastrophic failure of the unprotected fuel tank system. The only long-term issue here is the ongoing failure of NHTSA and Chrysler to fulfill their public duty (Tab E). This instant communication is meant to alert the dealerships of their similar real-world public duty.

**Conclusion**

As Chairman of the NADA, it is incumbent upon you to alert all dealer principals to these facts, furthering their existing duty and confirming their technical ability to obviate the portent of Tab A. I am confident that NADA members will characteristically fulfill their public duty through *“personal obligation to each customer”* (Tab F).

For an introduction to my person please review Tabs G thru K.<sup>6</sup> Please do not hesitate to contact me at any time.

Respectfully,

Paul V. Sheridan  
National Champion – Civil Justice Foundation

**Courtesy Copy List**<sup>1</sup>

The Honorable David L. Strickland  
Administrator  
NHTSA Headquarters/West Building  
1200 New Jersey Avenue, SE  
Washington, DC 20590  
888-327-4236

Mr. Clarence Ditlow, Director  
Center for Auto Safety - Suite 330  
1825 Connecticut Ave, NW  
Washington, DC 20009-5708  
202-328-7700

Ms. Angel M. DeFilippo, Esq.  
Grieco, Oates & DeFilippo, LLC  
Suite 200  
414 Eagle Rock Avenue  
West Orange, NJ 07052  
973-243-2099

Mr. Sergio Marchionne \*  
Chairman  
Chrysler Group LLC  
1000 Chrysler Drive  
Auburn Hills MI 48321-8004  
248-576-5741

Mr. Courtney E. Morgan, Jr.  
Morgan & Meyers, PLLC / Suite 320  
3200 Greenfield Road  
Dearborn, MI 48120  
313-961-0130

First Lady Michelle Obama \*\*  
The White House  
1600 Pennsylvania Avenue, NW  
Washington, DC 20500  
202-456-1414

**Endnotes**

---

<sup>1</sup> I had indicated this subject to the WSJ, including plaintiff attorney contact information, as a venue for making this incremental information available, but this discussion was not pursued for the 4 April 2012 article.

<sup>2</sup> Counsel for the Defense (Kline v Loman, et al.):

Mr. Christopher P. Fusco/Mr. Matthew D. Stockwell  
Callahan & Fusco, LLC - Suite 320  
72 Eagle Rock Avenue  
East Hanover, NJ, 07936  
973-818-9772

<sup>3</sup> As of this letter the four Congressmen have not had the courtesy or morality to respond to my letter of 13 February 2012.

<sup>4</sup> Not yet complete.

<sup>5</sup> The WJ-Body is the same engineered product [that President Obama has been boasting about](#) on his reelection campaign.

<sup>6</sup> For a perspective on the essential setting of my *ex parte* dismissal and court-ordered muzzling during the Christmas holidays of 1994 (while it was confirmed that I would be out of town), please review Tab 10 of current Tab B.

<sup>7</sup> Unless otherwise noted, by CD (electronic version) and/or email. Additional Courtesy Copy recipient contact information available upon request.

---

\* By personal hand delivery to Chrysler Group LLC Headquarters, 1000 Chrysler Drive, Auburn Hills MI

\*\* By USPS, cover letter only.

# Tab A

Honorable Judge David B. Rand order of 21 March 2012 affirming plaintiff's right to pursue punitive damage claim against automotive dealership in product liability litigation.

GRIECO, OATES & DE FILIPPO, LLC  
ATTORNEYS AT LAW  
414 EAGLE ROCK AVENUE  
SUITE 200  
WEST ORANGE, NEW JERSEY 07052  
Telephone No. (973) 243-2099  
Attorneys for the Plaintiff(s)

**FILED**

MAR 21 2012

DAVID B. RAND, P.J.C.V.  
JUDGE'S CHAMBERS  
MORRIS COUNTY COURTHOUSE

THOMAS KLINE, AS ADMINISTRATOR :  
AD PROSEQUENDUM OF THE HEIRS :  
AT LAW OF SUSAN MORRIS KLINE, :  
(DECEASED), AS ADMINISTRATOR :  
OF THE ESTATE OF SUSAN MORRIS :  
KLINE, and THOMAS KLINE, :  
INDIVIDUALLY, :

SUPERIOR COURT OF NEW JERSEY  
LAW DIVISION

MORRIS COUNTY  
DOCKET NO. MRS-L-3575-08

Plaintiff(s),

CIVIL ACTION

v.

**ORDER**

VICTORIA MORGAN-ALCALA, :  
CARLOS ALCALA, NATALIE RAWLS, :  
DAIMLER CHRYSLER CORPORATION, :  
A/K/A/ CHRYSLER CORPORATION, :  
LOMAN AUTO GROUP, CHRYSLER :  
GROUP, LLC (For Discovery Purposes), :  
JOHN DOES, A THROUGH Z, (Names :  
Being Fictitious), ABC CORPORATIONS, :  
1 THROUGH 100, (Names Being Fictitious):

Defendant(s)

THIS MATTER having been opened to the Court by Motion of Callahan and Fusco, LLC, attorneys for Loman Auto Group, and opposition having been filed by Grieco, Oates & DeFilippo, LLC, attorneys for Plaintiff(s) for an Order to Dismiss plaintiff's punitive damages claim, and the Court having considered this application as well as oral argument on March 16, 2012, and for good cause shown;

IT IS on this 21<sup>ST</sup> day of March 2012;

ORDERED that, should Defendant Loman Auto Group's motion to dismiss plaintiff's claim for punitive damages is hereby DENIED WITHOUT PREJUDICE; and it is further

ORDERED that a copy of the within Order be served upon all parties within seven (7) days hereof.

Reasons for this order were orally  
placed on the record on 3/16/2012

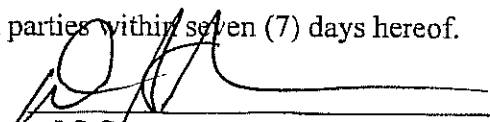
  
J.S.C. **DAVID B. RAND, P.J.CV.**

# Tab B

Paul V. Sheridan letter of 13 February 2012 to Congressmen:

***Representative Elijah Cummings***  
***Representative James D. Jordan***  
***Representative Mike Kelly***  
***Representative Dennis Kucinich***

**Subject:** 1993-2004 Jeep Grand Cherokee Post-Collision Fire Death Defect Investigation

**Reference:** House Oversight and Government Reform Hearing (Chevrolet Volt) of 25Jan2012

-----

## Tab B Intralinks

### Cover Letter

- Tab 1: Photographs of Susan Kline and Family
- Tab 2: Center for Auto Safety (CAS) Jeep Grand Cherokee Defect Petition October 2, 2009
- Tab 3: Paul V. Sheridan letter to CAS of June 1, 2010
- Tab 4: CAS letter to Chrysler-Fiat Chairman Sergio Marchionne of September 1, 2011
- Tab 5: Paul V. Sheridan letter to Mr. David Strickland of September 27, 2011
- Tab 6: CAS letter to Chrysler-Fiat Chairman Sergio Marchionne of November 17, 2011
- Tab 7: Paul V. Sheridan letter to Mr. David Strickland of December 5, 2011
- Tab 8: CAS letter to Chrysler-Fiat Chairman Sergio Marchionne of January 25, 2012
- Tab 9: ABC News Reports on Subject (dvd) + Digital version of this letter w/hyperlinks (cd)
- Tab 10: NHTSA-Chrysler-DOJ Defect Investigation FOIA Conspiracy



FedEx Express  
Customer Support Trace  
3875 Airways Boulevard  
Module H, 4th Floor  
Memphis, TN 38116

U.S. Mail: PO Box 727  
Memphis, TN 38194-4643  
Telephone: 901-369-3600

February 15, 2012

Dear Customer:

The following is the proof-of-delivery for tracking number **869449983913**.

---

**Delivery Information:**

---

|                       |                |                           |                            |
|-----------------------|----------------|---------------------------|----------------------------|
| <b>Status:</b>        | Delivered      | <b>Delivered to:</b>      | Shipping/Receiving         |
| <b>Signed for by:</b> | E.GREEN        | <b>Delivery location:</b> | 9140 EAST HAMPTON<br>20515 |
| <b>Service type:</b>  | FedEx 2Day Box | <b>Delivery date:</b>     | Feb 15, 2012 10:02         |



---

**Shipping Information:**

---

|                         |              |                   |                |
|-------------------------|--------------|-------------------|----------------|
| <b>Tracking number:</b> | 869449983913 | <b>Ship date:</b> | Feb 13, 2012   |
|                         |              | <b>Weight:</b>    | 5.0 lbs/2.3 kg |

**Recipient:**  
**REPELIJAH CUMMINGS**  
-  
2235 RAYBURN HOB  
20515 US

**Shipper:**  
PAUL SHERIDAN  
SHERIDAN, PAUL V  
22357 COLUMBIA ST  
481243431 US

**Reference** PE-10031

Thank you for choosing FedEx Express.

FedEx Worldwide Customer Service  
1.800.GoFedEx 1.800.463.3339



FedEx Express  
Customer Support Trace  
3875 Airways Boulevard  
Module H, 4th Floor  
Memphis, TN 38116

U.S. Mail: PO Box 727  
Memphis, TN 38194-4643  
Telephone: 901-369-3600

February 15, 2012

Dear Customer:

The following is the proof-of-delivery for tracking number **869449983898**.

---

**Delivery Information:**

---

|                       |                |                           |                            |
|-----------------------|----------------|---------------------------|----------------------------|
| <b>Status:</b>        | Delivered      | <b>Delivered to:</b>      | Shipping/Receiving         |
| <b>Signed for by:</b> | E.GREEN        | <b>Delivery location:</b> | 9140 EAST HAMPTON<br>20515 |
| <b>Service type:</b>  | FedEx 2Day Box | <b>Delivery date:</b>     | Feb 15, 2012 10:02         |



---

**Shipping Information:**

---

|                         |              |                   |                |
|-------------------------|--------------|-------------------|----------------|
| <b>Tracking number:</b> | 869449983898 | <b>Ship date:</b> | Feb 13, 2012   |
|                         |              | <b>Weight:</b>    | 5.0 lbs/2.3 kg |

**Recipient:**

REP JAMES JORDAN

-  
1524 LONGWORTH HOB  
20515 US

**Reference****Shipper:**

PAUL SHERIDAN  
SHERIDAN, PAUL V  
22357 COLUMBIA ST  
481243431 US

PE-10031

Thank you for choosing FedEx Express.

FedEx Worldwide Customer Service  
1.800.GoFedEx 1.800.463.3339



FedEx Express  
Customer Support Trace  
3875 Airways Boulevard  
Module H, 4th Floor  
Memphis, TN 38116

U.S. Mail: PO Box 727  
Memphis, TN 38194-4643  
Telephone: 901-369-3600

February 15, 2012

Dear Customer:

The following is the proof-of-delivery for tracking number **869449983924**.

---

**Delivery Information:**

---

|                       |                |                           |                            |
|-----------------------|----------------|---------------------------|----------------------------|
| <b>Status:</b>        | Delivered      | <b>Delivered to:</b>      | Shipping/Receiving         |
| <b>Signed for by:</b> | E.GREEN        | <b>Delivery location:</b> | 9140 EAST HAMPTON<br>20515 |
| <b>Service type:</b>  | FedEx 2Day Box | <b>Delivery date:</b>     | Feb 15, 2012 10:02         |



---

**Shipping Information:**

---

|                         |              |                   |                |
|-------------------------|--------------|-------------------|----------------|
| <b>Tracking number:</b> | 869449983924 | <b>Ship date:</b> | Feb 13, 2012   |
|                         |              | <b>Weight:</b>    | 5.0 lbs/2.3 kg |

**Recipient:**  
**REP MIKE KELLY**  
515 CANNON 40B  
20515 US

**Shipper:**  
PAUL SHERIDAN  
SHERIDAN, PAUL V  
22357 COLUMBIA ST  
481243431 US

**Reference** PE-10031

Thank you for choosing FedEx Express.

FedEx Worldwide Customer Service  
1.800.GoFedEx 1.800.463.3339





FedEx Express  
Customer Support Trace  
3875 Airways Boulevard  
Module H, 4th Floor  
Memphis, TN 38116

U.S. Mail: PO Box 727  
Memphis, TN 38194-4643  
Telephone: 901-369-3600

February 15, 2012

Dear Customer:

The following is the proof-of-delivery for tracking number **869449983902**.

---

**Delivery Information:**

---

|                       |                |                           |                            |
|-----------------------|----------------|---------------------------|----------------------------|
| <b>Status:</b>        | Delivered      | <b>Delivered to:</b>      | Shipping/Receiving         |
| <b>Signed for by:</b> | E.GREEN        | <b>Delivery location:</b> | 9140 EAST HAMPTON<br>20515 |
| <b>Service type:</b>  | FedEx 2Day Box | <b>Delivery date:</b>     | Feb 15, 2012 10:02         |



---

**Shipping Information:**

---

|                         |              |                   |                |
|-------------------------|--------------|-------------------|----------------|
| <b>Tracking number:</b> | 869449983902 | <b>Ship date:</b> | Feb 13, 2012   |
|                         |              | <b>Weight:</b>    | 5.0 lbs/2.3 kg |

**Recipient:**  
**RED DENNIS KUCINICH**

-  
2445 RAYBURN HOB  
20515 US

**Reference**

**Shipper:**  
PAUL SHERIDAN  
SHERIDAN, PAUL V  
22357 COLUMBIA ST  
481243431 US  
PE-10031

Thank you for choosing FedEx Express.

FedEx Worldwide Customer Service  
1.800.GoFedEx 1.800.463.3339

DDM Consultants  
22357 Columbia Street  
Dearborn, MI 48124-3431  
313-277-5095  
[pvs6@Cornell.edu](mailto:pvs6@Cornell.edu)

13 February 2012

Representative Elijah Cummings  
2235 Rayburn House Office Building  
Washington, DC 20515-2007  
202-225-4741

Representative Mike Kelly  
515 Cannon House Office Building  
Washington, DC 20515-3803  
202-225-5406

Representative James D. Jordan  
1524 Longworth House Office Building  
Washington, DC 20515-3504  
202-225-2676

Representative Dennis Kucinich  
2445 Rayburn House Office Building  
Washington, DC 20515-3510  
202-225-5871

**Subject: 1993-2004 Jeep Grand Cherokee Post-Collision Fire Death Defect Investigation**  
**Reference: House Oversight and Government Reform Hearing (Chevrolet Volt) of 25Jan2012**

Gentlemen:

Before we discuss the subject/reference, I am compelled to impose upon you. Please first review the contents of Tab 1. Please now review Page 4 of Tab 4.

-----

In the instance of Mrs. Susan Kline, she was **not** a passenger in a Chevrolet Volt during a routine NHTSA crash test. This is also true for [Cassidy Jarmon](#), when this lovely 4-year-old toddler was horribly burned to death in 2006. Similar horror has afflicted many others.

Hearings convened at taxpayer expense which are focused on allegations of politically-biased misdeeds are not unusual. But when politics interferes-with or diverts attention from truly meritorious safety issues, then notice must be placed.

[In your hearing with Mr. David Strickland](#) of the National Highway Traffic Safety Administration (NHTSA), you appeared satisfied with the notion that the post-collision fire injury/death risk of the Chevrolet Volt is "*no greater than gasoline fueled vehicles.*" This notion lacks perspective and priority.

As Mr. Strickland is fully aware, **during** the time that taxpayer dollars were expended on investigation of the Chevrolet Volt post-crash test technician issues\*, at least three additional horrific fire-related death and injuries occurred in the subject vehicles. The NHTSA investigation into these defective 1993 through 2004 Jeep Grand Cherokee vehicles has been dragging on since October 2, 2009. If you doubt my studied opinion that the subject vehicles are not crashworthy, and therefore are defective, then perhaps you should review the sworn testimony of the Chrysler executive engineer that is responsible for the design.

\* Although serious, this issue resulted in a minor fire, occurring three days later in an abandoned junk yard wherein no one was injured, let-alone burned to death.

On March 14, 1996, [in a Jeep crashworthiness severe-injury litigation](#), Chrysler Executive Vice President of Engineering and then Jeep Product Executive Mr. Francois J. Castaing testified as follows:

Plaintiff: ***What does the term crashworthiness mean in terms of design of a product?***

Castaing: ***I don't know. Tell me.***

Plaintiff: ***You don't know the phrase?!***

Castaing: ***No.***

Plaintiff: ***Well, let me make sure I'm clear on this. As the chief engineer of the company, are you at all familiar with the use of the phrase 'crashworthiness' by the engineers of the company?***

Castaing: ***Crashworthiness is so vague that you have to tell me what you intend by that.***

I am confident that no General Motors executive has testified in a similar manner regarding the Chevrolet Volt. (Formerly Mr. Castaing reported to Chrysler President Robert A. Lutz, who is currently functioning as a consultant to GM on issues such as the Chevrolet Volt.)

#### Delayed public notification of a serious safety risk?

Congressman Jordan proclaimed that the issue was "*delayed public notification of a serious safety risk.*" In this context I am requesting that you convene hearings on NHTSA PE-10031. To introduce you to the merits of this request I am (also) attaching the following documents:

- Tab 2: Center for Auto Safety (CAS) Jeep Grand Cherokee Defect Petition of October 2, 2009
- Tab 3: Paul V. Sheridan letter to CAS of June 1, 2010
- Tab 4: CAS letter to Chrysler-Fiat Chairman Sergio Marchionni of September 1, 2011
- Tab 5: Paul V. Sheridan letter to Mr. David Strickland of September 27, 2011
- Tab 6: CAS letter to Chrysler-Fiat Chairman Sergio Marchionni of November 17, 2011
- Tab 7: Paul V. Sheridan letter to Mr. David Strickland of December 5, 2011
- Tab 8: CAS letter to Chrysler-Fiat Chairman Sergio Marchionni of January 25, 2012
- Tab 9: ABC News Reports on Subject (dvd) + Digital version of this letter w/hyperlinks (cd)
- Tab 10: NHTSA-Chrysler-DOJ Defect Investigation FOIA Conspiracy

I am not discounting the additional context voiced at the reference, that political and corporate influence has the potential to corrupt the primary mission of NHTSA: the safety and well-being of all who utilize American roadways. Indeed, I am not aware of any other automotive safety expert that has been victimized by that influence to a greater extent than the undersigned (Tab 10).

I am confident that President Obama was not aware of the Castaing testimony [at the time he purchased his 2000 Jeep Grand Cherokee](#). Ostensibly speaking, your satisfaction with the notion that the post-collision fire injury/death risk of electric vehicles is "*no greater than*" the 1993 through 2004 Jeep Grand Cherokee lacks proper perspective and priority.

Respectfully,

Paul V. Sheridan  
National Champion – Civil Justice Foundation

### **Courtesy Copy List**

(Cover Letter plus Tab 10 Only)

The Honorable David L. Strickland  
Administrator  
NHTSA Headquarters/West Building  
1200 New Jersey Avenue, SE  
Washington, DC 20590  
888-327-4236

Mr. Daniel F. Akerson  
Chairman and CEO  
General Motors  
300 Renaissance Center #L1  
Detroit, MI 48243-1403  
313-556-5000

Mr. Courtney E. Morgan, Jr. ■  
Morgan & Meyers, PLLC / Suite 320  
3200 Greenfield Road  
Dearborn, MI 48120  
313-961-0130

Congressman John D. Dingell ■  
2328 Rayburn House Office Building  
District of Columbia 20515-2215  
202-225-4071

Mr. Clarence Ditlow, Director ■  
Center for Auto Safety  
Suite 330  
1825 Connecticut Ave, NW  
Washington, DC 20009-5708  
202-328-7700

Mr. Robert A. Lutz ■  
Technical Consultant  
General Motors  
300 Renaissance Center #L1  
Detroit, MI 48243-1403  
313-556-5000

Mr. Lewis H. Goldfarb ■  
1300 Mount Kemble Avenue  
P.O. Box 2075  
Morristown, NJ 07962-2075  
973-993-8100

Mr. Otto Matheke ■  
Senior Attorney  
NHTSA Headquarters/West Building  
1200 New Jersey Avenue, SE  
Washington, DC 20590  
888-327-4236

- Individuals directly involved with the portent and consequences of Tab 10.
- Individuals familiar with the portent and/or consequences of Tab 10.

# Tab 1

## Photographs of Susan Kline and Family

-----

Paul V. Sheridan letter of 13 February 2012 to Congressmen:

Representative Elijah Cummings  
Representative James D. Jordan  
Representative Mike Kelly  
Representative Dennis Kucinich

Subject: 1993-2004 Jeep Grand Cherokee Post-Collision Fire Death Defect Investigation  
Reference: House Oversight and Government Reform Hearing (Chevrolet Volt) of 25Jan2012



Mrs. Susan Kline with her family.

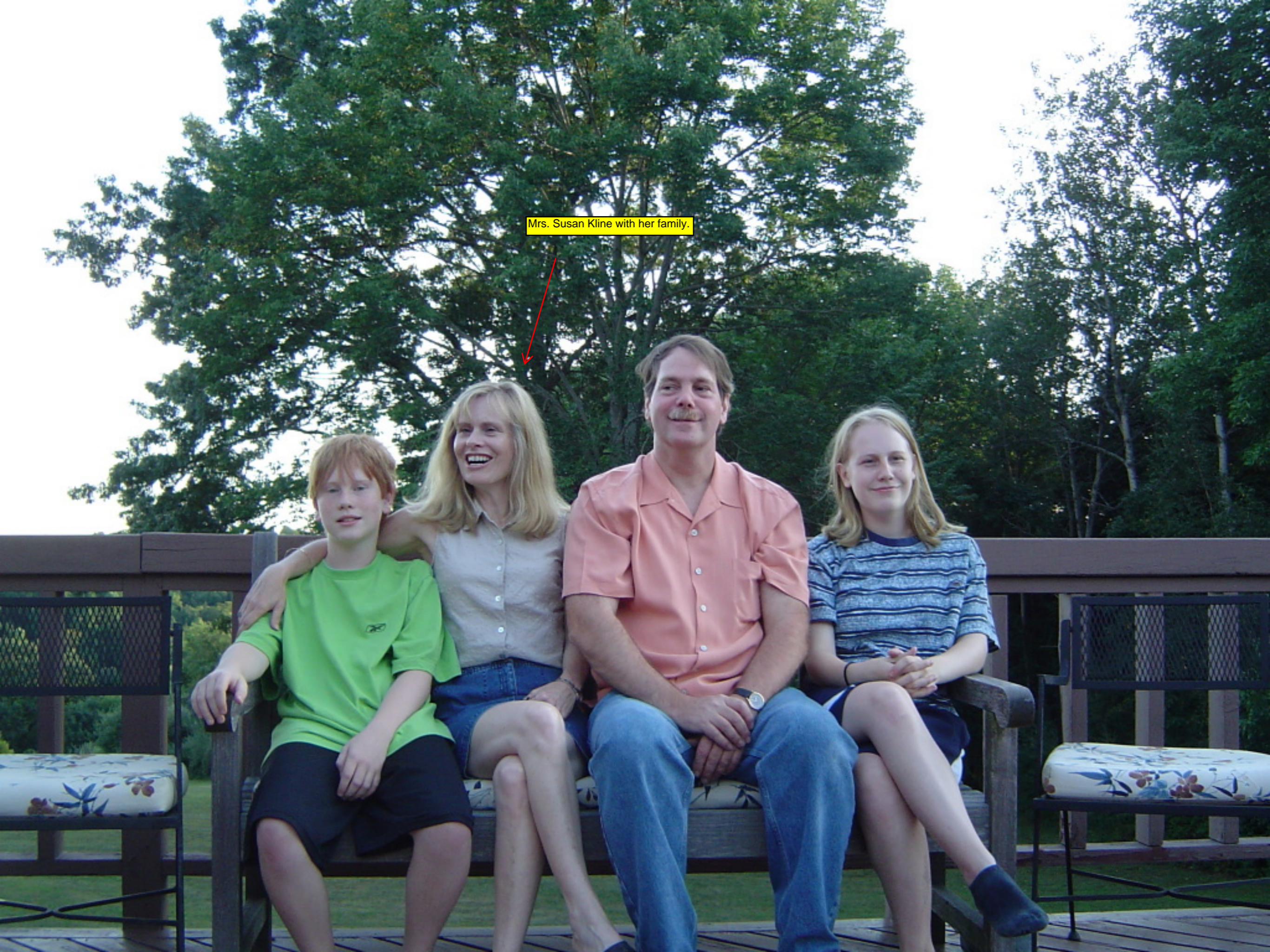





Skull

Jaw Bone



Mrs. Susan Kline (death victim).  
Post fuel-fed fire caused by defective fuel system/tank  
design in Jeep Grand Cherokee SUVs

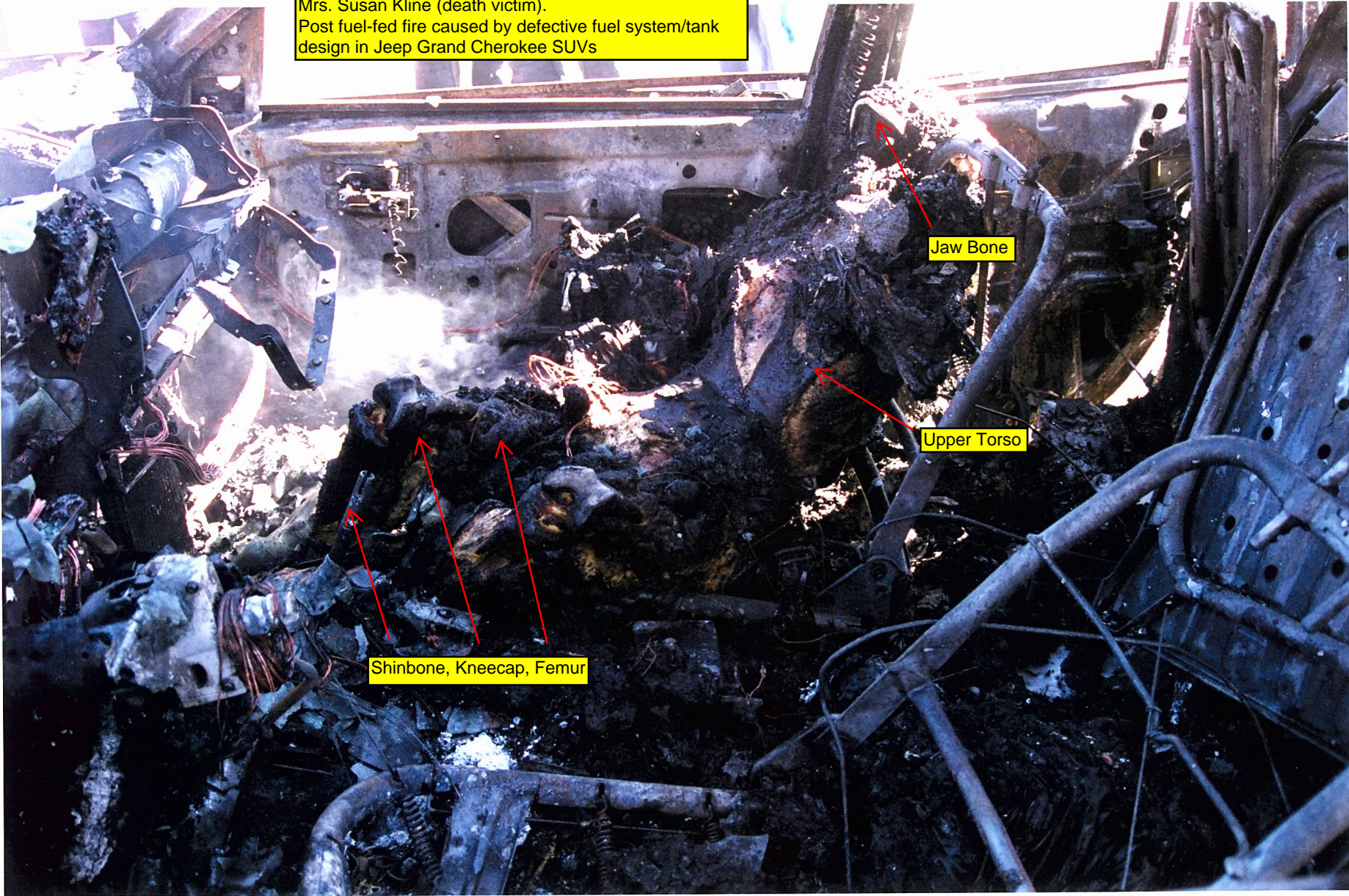

Jaw Bone

Upper Torso

Shinbone, Kneecap, Femur



## Tab 2

### Center for Auto Safety (CAS) Jeep Grand Cherokee Defect Petition of October 2, 2009

-----  
Paul V. Sheridan letter of 13 February 2012 to Congressmen:

Representative Elijah Cummings  
Representative James D. Jordan  
Representative Mike Kelly  
Representative Dennis Kucinich

Subject: 1993-2004 Jeep Grand Cherokee Post-Collision Fire Death Defect Investigation  
Reference: House Oversight and Government Reform Hearing (Chevrolet Volt) of 25Jan2012

# CENTER FOR AUTO SAFETY

1825 CONNECTICUT AVENUE NW SUITE 330 WASHINGTON DC 20009-5708  
202-328-7700 ◆ www.autosafety.org

October 2, 2009

Ronald Medford, Acting Deputy Administrator  
National Highway Traffic Safety Administration  
1200 New Jersey Avenue SE  
Washington DC 20590

## PETITION

Dear Deputy Administrator Medford:

The Center for Auto Safety (CAS) petitions the National Highway Traffic Safety Administration (NHTSA) to initiate a defect investigation into and recall all 1993-2004 Jeep Grand Cherokee with a fuel tank located behind the rear axle. Unlike the earlier Jeep Cherokee, the fuel tank of the Grand Cherokee is plastic and extends below the rear bumper so there is nothing to protect the tank from a direct hit in a rollover or by a vehicle with a low front profile or one lowered by pre-impact braking.

The design is so bad that Chrysler frequently settles lawsuits without extensive discovery and subject to confidentiality agreements. A search of NHTSA's FARS files for fatal fire crashes where there was a fire occurrence in a 1993-2004 Jeep Grand Cherokee from calendar year 1992 through 2008 found 172 fatal fire crashes with 254 fatalities. (Attachment A.) With an additional known fatal fire crash in 2009, there have been at least 44 crashes with 64 fatalities where the Most Harmful Event is fire.<sup>1</sup> (Attachment B.) In comparison, NHTSA reported a total of 38 fire crashes involving only 26 fire deaths in the Ford Pinto when it issued its initial defect report in May 1978. (Attachment C.)

The fuel system in the 1993-04 Grand Cherokee is defectively designed in that it contains a plastic fuel tank subject to rupture, degrades in performance over time, a fuel filler neck that tears off in a range of crashes, a hostile environment with sharp objects such as suspension bolts that can puncture the tank, extends below the bumper and is unshielded although Chrysler offers a optional 3/16" steel shield as a "skid plate" for off road use which would protect the tank in rear impacts where there is pre-crash braking of the striking vehicle. Similar shields are offered in the aftermarket by companies like Quadratec and take advantage of OEM holes in the frame rail to mount the shields.<sup>2</sup>

With funding from General Motors, the Motor Vehicle Fire Research Institute (MVFRI) has performed detailed technical assignments of the fuel tanks and fuel systems in motor vehicles. As pointed out in the assessment of the 2003 Grand Cherokee, the rear sway bar link bolt is only

---

<sup>1</sup> This excludes FARS Case 60718 on March 16, 1996 in California involving a crash between a 1996 Grand Cherokee and a classic 1971 Ford Mustang which also had a known fuel tank hazard.

<sup>2</sup> [http://www.quadratec.com/products/12500\\_301.htm](http://www.quadratec.com/products/12500_301.htm)

3 centimeters away from the plastic tank and could easily puncture the tank in a crash.<sup>3</sup> MVFRI also found that plastic fuel tanks, particularly those like the 1993-04 Grand Cherokee located behind the rear axle, degraded in performance over time and were more subject to leakage in crashes.<sup>4</sup>

After it became a merged company with Mercedes, DaimlerChrysler moved the fuel tank in board of the rear axle in 2005 and shielded it. Since the relocation of the fuel tank in 2005 and later Grand Cherokees, there has only been one fatal fire crash in the redesigned vehicle. And that fire occurred after both occupants had been ejected in a rollover of a 2008 Grand Cherokee so that the deaths were not caused by fire.

Due to confidential settlements, the details of most lawsuits are not available. What is available demonstrates the existence of a safety defect in this vehicle. In Smith v Chrysler, the attorneys identified a common hazard as the location of the tank and a filler neck that easily torn off in a crash as fire hazards. In this case, a 2001 Grand Cherokee was beginning to go through a green light when it was struck in the rear by a Town Car traveling at only 20 to 25 miles per hour. (Attachment E.) In FARS case 360720 in Long Island NY on September 1, 1999, a stopped 1997 Grand Cherokee was struck from behind by a braking Toyota MR2. Two sisters in the back of the Grand Cherokee were severely burned when they could not get out of the Jeep due to jammed doors. The driver of the MR2, a gardener from Whitmore's, was fatally burned as he was enveloped by the burning fuel from the ruptured tank of the Grand Cherokee.

Susan Kline of New Jersey was in a 1996 Grand Cherokee when it was struck from behind by a 2004 Toyota Sienna. The doors on the Jeep jammed in the impact. Mrs. Kline climbed from the driver side to the passenger side trying to get out of the burning vehicle but was unsuccessful. Her skeletal body was found in the passenger seat. (Attachment F.) This crash and the Long Island crash both demonstrate the unique hazards of an unshielded tank extending below the rear bumper where it can be engaged by the lowered front of a striking vehicle and shoved up into the structure of the vehicle above the tank and ruptured. The low hanging, exposed fuel tank of the 1993-04 Grand Cherokee is also particular vulnerable in rollover crashes where it can strike fixed objects as it rolls. Later model Grand Cherokees have a 1milimeter brush guard that is cosmetic and offers no protection. The optional skid plate offered by Chrysler and aftermarket manufacturers is three times as thick and provides protection in such crashes.

Just like the 1971-76 Ford Pinto and 1973-87 General Motors in which NHTSA made initial determinations of safety defects despite both vehicles meeting FMVSS 301, the Grand Cherokee purportedly met FMVSS 301 although early 2002 models were subject to a non-compliance recall, 02V-032. However, as show above the Grand Cherokee contains safety defects not covered by the performance requirements of FMVSS 301 and should be recalled.

Ironically, New Chrysler tried to escape liability for all future Grand Cherokee crashes occurring after the bankruptcy where the vehicle was sold before the bankruptcy. Just days after the bankruptcy, Rodney Wood was killed in his 2004 Grand Cherokee on July 10, 2009 when it was

---

<sup>3</sup> [www.mvfri.org/Contracts/Final%20Reports/Biokinetics-Phase-II/ReportTool/vehiclefiles/index.html#2](http://www.mvfri.org/Contracts/Final%20Reports/Biokinetics-Phase-II/ReportTool/vehiclefiles/index.html#2).

<sup>4</sup> K Digges, et al, "Fire Safety Performance in Crashes," ESV Conference 2003. (Attachment D.)

hit by a transit bus.<sup>5</sup> The autopsy showed he died by fire, not by the trauma of the impact. Under intense public pressure, New Chrysler relented and agreed to cover future product liability losses. (Attachment H.) However New Chrysler still refused to accept responsibility for victims like Susan Klein whose tragic crashes occurred prior to the bankruptcy.

The 1993-04 Grand Cherokee has a fatal crash fire occurrence rate that is about four times higher than SUVs made by other companies. Comparing the 1993-04 Grand Cherokee with the exposed rear fuel tank to the 2005 and later Grand Cherokee with the shielded fuel tank in front of rear axle in the first five years of use for both vehicles so that it's an apples to apples comparison, the defective old Grand Cherokee has a fatal fire rate six times higher than the new Grand Cherokee.

To protect the public from more fire deaths and injuries in the 1993-04 Grand Cherokee as they continue to crash and burn, the Center for Auto Safety requests an immediate recall.

Respectfully submitted,



Clarence M. Ditlow

---

<sup>5</sup> Attachment G is a copy of the initial police report.

**Attachment A**  
**MY 1993-2008 Jeep Grand Cherokee Fatal Fire Crashes, 1992-2008**

### **MY 1993-2008 Jeep Grand Cherokee Fatal Fire Crashes, 1992-2008**

This table includes known fire crashes obtained from NHTSA's Fatal Analysis Crash System (FARS) for Calendar Years 1992-2008 and from public records for other years and for crashes not listed in FARS. Where FARS indicates fire is the most harmful event, that is indicated. Where FARS indicates vehicle in transport, striking tree or other object, that is indicated.

| Crash Date by State        | Name                  | City/County         | Road                     | Deaths | Make/Model/Year     | FARS # |
|----------------------------|-----------------------|---------------------|--------------------------|--------|---------------------|--------|
| <b>Alabama</b>             |                       |                     |                          |        |                     |        |
| 09/26/01**                 | FARS (overturn)       | Blount Co.          | US-SR74                  | 2      | 2000 Grand Cherokee | 10627  |
| 04/12/06 <sup>F</sup>      | FARS                  | Montgomery          | 5466                     | 1      | 2004 Grand Cherokee | 10243  |
| 04/25/07 <sup>F</sup>      | FARS                  | Macon Co.           | I-85                     | 1      | 1993 Grand Cherokee | 10270  |
| <b>Alaska</b>              |                       |                     |                          |        |                     |        |
| 10/12/02*                  | FARS                  | Kenai Peninsula     | I-A3-2 Seward            | 2      | 2000 Grand Cherokee | 20053  |
| <b>Arizona</b>             |                       |                     |                          |        |                     |        |
| 02/01/98 <sup>F</sup>      | FARS                  | Gila Co.            | Old Dripping Springs     | 1      | 1993 Grand Cherokee | 40059  |
| 08/18/98**                 | FARS (bridge rail)    | Mohave Co.          | I-15                     | 1      | 1995 Grand Cherokee | 40506  |
| 03/13/01 <sup>F</sup>      | FARS                  | Mohave Co.          | I-40                     | 2      | 1994 Grand Cherokee | 40104  |
| 11/26/06*†(1)              | FARS                  | Surprise            | US-60 R.H. Johnson Blvd. | 1      | 1995 Grand Cherokee | 40874  |
| <b>Arkansas</b>            |                       |                     |                          |        |                     |        |
| 09/14/04*†(1)              | FARS                  | Carroll Co.         | US-62-05                 | 2      | 1999 Grand Cherokee | 50451  |
| <b>California</b>          |                       |                     |                          |        |                     |        |
| 03/06/96*†(1)              | FARS                  | Indio               | Country Club Dr.         | 2      | 1993 Grand Cherokee | 60665  |
| 03/16/96 <sup>F</sup> †(5) | FARS                  | Carson              | 91                       | 5      | 1996 Grand Cherokee | 60718  |
| 07/07/96 <sup>F</sup> †(1) | FARS                  | Poway               | Espola Rd.               | 1      | 1993 Grand Cherokee | 61698  |
| 06/14/98**†(1)             | FARS (barrier)        | Victorville         | I-15                     | 1      | 1993 Grand Cherokee | 60918  |
| 10/27/99 <sup>F</sup>      | Young Sup Lee         | Los Angeles         | SR-170                   | 1      | 1998 Grand Cherokee | 62795  |
| 05/07/00 <sup>F</sup>      | FARS                  | Orange Co.          | SR-241                   | 1      | 1993 Grand Cherokee | 60499  |
| 07/20/01 <sup>F</sup>      | FARS                  | San Bernardino Co.  | I-10                     | 1      | 1994 Grand Cherokee | 61708  |
| 08/07/01**                 | FARS (tree)           | Los Gatos           | SR-17                    | 1      | 1998 Grand Cherokee | 62067  |
| 03/23/02*†(1)              | FARS                  | Sutter Co.          | SR-99                    | 2      | 1995 Grand Cherokee | 61045  |
| 07/13/02**                 | FARS                  | San Luis Obispo Co. | Orcutt Rd.               | 1      | 2000 Grand Cherokee | 60896  |
| 08/30/02 <sup>F</sup>      | FARS                  | Bakersfield         | SR-58                    | 1      | 1993 Grand Cherokee | 62653  |
| 10/11/02**                 | FARS (overturn)       | Fresno Co.          | I-5                      | 1      | 1993 Grand Cherokee | 62779  |
| 10/04/03*                  | FARS                  | Anaheim             | S. Harbor Blvd.          | 2      | 2004 Grand Cherokee | 62897  |
| 11/27/03**                 | FARS (utility pole)   | Commerce            | Slauson Ave.             | 1      | 1996 Grand Cherokee | 63251  |
| 02/05/04*                  | FARS                  | San Bernardino Co.  | I-15                     | 1      | 1995 Grand Cherokee | 60339  |
| 05/26/04**†(2)             | FARS (overturn)       | Vacaville           | I-80                     | 4      | 2004 Grand Cherokee | 61401  |
| 06/08/04**                 | FARS (parked vehicle) | Riverside Co.       | I-10                     | 1      | 1997 Grand Cherokee | 61466  |
| 08/18/05 <sup>F</sup>      | James Lindskog        | Oceanside           | Vista Way                | 1      | 1994 Grand Cherokee | 63236  |
| 05/24/06 <sup>F</sup> †(1) | FARS                  | Orange Co.          | SR-241                   | 2      | 2001 Grand Cherokee | 61349  |

| Crash Date by State   | Name                   | City/County       | Road                           | Deaths | Make/Model/Year     | FARS # |
|-----------------------|------------------------|-------------------|--------------------------------|--------|---------------------|--------|
| 06/25/06**            | FARS (tree)            | Sonoma Co.        | Petrified Forest Rd. Sharp Rd. | 1      | 1993 Grand Cherokee | 62934  |
| <b>Colorado</b>       |                        |                   |                                |        |                     |        |
| 07/24/94*             | FARS                   | Denver            | Martin Luther King Blvd.       | 1      | 1994 Grand Cherokee | 80258  |
| 09/02/02**            | FARS (overturn)        | Douglas Co.       | SR-470                         | 1      | 1993 Grand Cherokee | 80460  |
| 01/10/05 <sup>F</sup> | FARS                   | Mesa Co.          | Rim Rock Dr.                   | 1      | 2004 Grand Cherokee | 80025  |
| 07/06/08**            | FARS (boulder)         | Garfield Co.      | US-6                           | 1      | 1997 Grand Cherokee | 80229  |
| <b>Connecticut</b>    |                        |                   |                                |        |                     |        |
| 04/10/97**            | FARS (tree)            | Washington        | 199                            | 1      | 1994 Grand Cherokee | 90062  |
| 04/19/02**            | FARS (tree)            | Hamden            | New Rd.                        | 1      | 1994 Grand Cherokee | 90113  |
| <b>Delaware</b>       |                        |                   |                                |        |                     |        |
| 09/11/03*             | FARS                   | Sussex Co.        | CR321                          | 1      | 1993 Grand Cherokee | 100090 |
| <b>D.C.</b>           |                        |                   |                                |        |                     |        |
| <b>Florida</b>        |                        |                   |                                |        |                     |        |
| 11/16/98*†(2)         | FARS                   | Hillsborough Co.  | SR580                          | 2      | 1998 Grand Cherokee | 122093 |
| 11/17/01**            | FARS (overturn)        | Jacksonville      | I-295                          | 1      | 1996 Grand Cherokee | 122302 |
| 09/05/07 <sup>F</sup> | FARS                   | N/A               | SR-944 32 <sup>nd</sup> Ave.   | 2      | 1998 Grand Cherokee | 122577 |
| <b>Georgia</b>        |                        |                   |                                |        |                     |        |
| 12/04/97*             | FARS                   | Wilkes Co.        | SR10                           | 1      | 1997 Grand Cherokee | 131268 |
| 07/14/98*             | FARS                   | Echols Co.        | US-SR89                        | 3      | 1993 Grand Cherokee | 130723 |
| 12/13/98**            | FARS (tree)            | Forsyth Co.       | SR-371                         | 1      | 1996 Grand Cherokee | 131315 |
| 05/30/99**            | FARS (embankment)      | Jones Co.         | US-129(SR-11)                  | 2      | 1994 Grand Cherokee | 130444 |
| 08/13/01**            | FARS (barrier)         | DeKalb Co.        | I-20 (SR 402)                  | 1      | 1998 Grand Cherokee | 130795 |
| 10/30/04*†(4)         | FARS                   | Tift Co.          | I-75                           | 4      | 1999 Grand Cherokee | 131171 |
| 03/08/05 <sup>F</sup> | FARS                   | Paulding Co.      | N/A                            | 1      | 1999 Grand Cherokee | 130196 |
| 03/09/05 <sup>F</sup> | FARS                   | Macon Co.         | SR-49                          | 1      | 1997 Grand Cherokee | 130197 |
| 03/24/05*             | FARS                   | Barrow Co.        | SR-11                          | 1      | 1993 Grand Cherokee | 130251 |
| 06/20/06*             | FARS                   | Polk              | SR-101                         | 1      | 2003 Grand Cherokee | 130713 |
| 09/04/07**            | FARS (overturn)        | McDuffie Co.      | SR-223                         | 1      | 1998 Grand Cherokee | 130958 |
| <b>Illinois</b>       |                        |                   |                                |        |                     |        |
| 09/04/00 <sup>F</sup> | Nguyen, Bui, Vo, Prith | Chicago           | I-90/94                        | 6      | 1993 Grand Cherokee | 170827 |
| 03/02/01*             | FARS                   | Elk Grove Village | Thorndale Ave.                 | 1      | 1998 Grand Cherokee | 170153 |
| 08/12/02**            | FARS (tree)            | Barrington Hills  | Spring Creek Rd.               | 1      | 1998 Grand Cherokee | 170755 |
| 03/16/03*             | FARS                   | Livingston Co.    | SR-17                          | 1      | 1994 Grand Cherokee | 170248 |



| Crash Date by State        | Name                | City/County    | Road                  | Deaths | Make/Model/Year     | FARS # |
|----------------------------|---------------------|----------------|-----------------------|--------|---------------------|--------|
| 10/11/03*†(1)              | FARS                | Union Co.      | I-57                  | 2      | 1996 Grand Cherokee | 171040 |
| 02/16/04*                  | FARS                | Kankakee Co.   | SR-113 7000 West      | 2      | 1999 Grand Cherokee | 170112 |
| 06/02/05*†(1)              | FARS                | Coles Co.      | SR-16                 | 2      | 1999 Grand Cherokee | 170556 |
| 10/23/05*†(1)              | FARS                | Iroquois Co.   | I-57                  | 1      | 1998 Grand Cherokee | 170921 |
| 01/04/06*†(1)              | FARS                | South Elgin    | SR-25                 | 2      | 2001 Grand Cherokee | 170006 |
| 03/18/07**                 | FARS (overturn)     | Du Page Co.    | I-290 WB Ramp to 355S | 2      | 1995 Grand Cherokee | 170143 |
| 10/16/07 <sup>F</sup>      | FARS                | La Salle Co.   | I-39                  | 2      | 1993 Grand Cherokee | 170830 |
| <b>Indiana</b>             |                     |                |                       |        |                     |        |
| 04/27/98*†(1)              | FARS                | Clay Co.       | I-70                  | 3      | 1997 Grand Cherokee | 180232 |
| 09/16/04 <sup>F</sup>      | FARS                | Warrick Co.    | I-64                  | 1      | 2004 Grand Cherokee | 180705 |
| 11/13/04 <sup>F</sup>      | FARS                | Noble Co.      | US-33                 | 4      | 1997 Grand Cherokee | 180723 |
| 10/10/08**                 | FARS (tree)         | Taylorsville   | I-65                  | 1      | 1994 Grand Cherokee | 180552 |
| <b>Iowa</b>                |                     |                |                       |        |                     |        |
| 09/07/01**                 | FARS (overturn)     | Patterson      | US-92                 | 1`     | 2001 Grand Cherokee | 190254 |
| <b>Kentucky</b>            |                     |                |                       |        |                     |        |
| 02/13/00 <sup>F</sup>      | FARS                | Bourbon Co.    | Vemont Ln.            | 1      | 1997 Grand Cherokee | 210052 |
| 08/07/06*†(1)              | FARS                | Boone Co.      | SR-536                | 1      | 1998 Grand Cherokee | 210489 |
| <b>Louisiana</b>           |                     |                |                       |        |                     |        |
| 08/31/00*                  | FARS                | Livingston Co. | I-12                  | 1      | 1997 Grand Cherokee | 220509 |
| 12/10/00*                  | FARS                | St. Martin Co. | I-10                  | 2      | 1997 Grand Cherokee | 220771 |
| 07/20/03 <sup>F</sup> †(3) | FARS                | St. Martin Co. | I-10                  | 5      | 2000 Grand Cherokee | 220401 |
| 07/16/04**                 | FARS (utility pole) | Bossier City   | US-80 SR-72           | 2      | 1999 Grand Cherokee | 220414 |
| 10/09/04**                 | FARS (tree)         | Franklin Co.   | SR-4 School St.       | 1      | 1995 Grand Cherokee | 220625 |
| <b>Maryland</b>            |                     |                |                       |        |                     |        |
| 11/29/98*                  | FARS                | Baltimore Co.  | SR-147                | 2      | 1993 Grand Cherokee | 240486 |
| <b>Massachusetts</b>       |                     |                |                       |        |                     |        |
| 03/04/07**                 | FARS (overturn)     | Centerville    | SR-28 Harrison Road   | 2      | 2004 Grand Cherokee | 250100 |
| 04/29/07**                 | FARS (tree)         | South Easton   | SR-106                | 1      | 1993 Grand Cherokee | 250070 |
| <b>Michigan</b>            |                     |                |                       |        |                     |        |
| 12/04/97*                  | FARS                | Dickinson Co.  | 95                    | 1      | 1994 Grand Cherokee | 261050 |
| 01/03/03**                 | FARS (tree)         | Ottawa Co.     | Lakewood Blvd.        | 1      | 1993 Grand Cherokee | 260036 |
| 04/30/05 <sup>F</sup> †(1) | FARS                | Oakland Co.    | I-75                  | 3      | 2004 Grand Cherokee | 260239 |
| 08/16/08**                 | FARS (overturn)     | Kalkaska Co.   | Plum Valley Rd.       | 1      | 1996 Grand Cherokee | 260547 |

| Crash Date by State        | Name                | City/County       | Road                 | Deaths | Make/Model/Year     | FARS # |
|----------------------------|---------------------|-------------------|----------------------|--------|---------------------|--------|
| <b>Minnesota</b>           |                     |                   |                      |        |                     |        |
| 02/09/98*                  | FARS                | Carlton Co.       | SR-33                | 1      | 1994 Grand Cherokee | 270039 |
| 11/15/98*†(1)              | FARS                | Maple Grove       | I-94                 | 1      | 1993 Grand Cherokee | 270520 |
| 11/03/02*                  | FARS                | Scott Co.         | I-35                 | 1      | 2001 Grand Cherokee | 270542 |
| 04/15/03*                  | FARS                | Aitkin Co.        | 28                   | 1      | 2000 Grand Cherokee | 270128 |
| 07/14/03*†(1)              | FARS                | Maple Grove       | I-94                 | 1      | 1993 Grand Cherokee | 270274 |
| 12/29/03**                 | FARS (overturn)     | Lac Qui Parle Co. | T-148                | 1      | 1995 Grand Cherokee | 270511 |
| 06/06/04**                 | FARS (overturn)     | Washington Co.    | T92                  | 1      | 1999 Grand Cherokee | 270160 |
| 05/24/05**                 | FARS (overturn)     | Carver Co.        | 13                   | 4      | 1994 Grand Cherokee | 270148 |
| 01/27/06*                  | FARS                | Brown Co.         | 25                   | 1      | 2004 Grand Cherokee | 270038 |
| 03/21/08*†(1)              | FARS                | St. Louis Co.     | SR-169 CR88          | 2      | 1995 Grand Cherokee | 270070 |
| <b>Mississippi</b>         |                     |                   |                      |        |                     |        |
| 12/27/99*                  | FARS                | Hancock Co.       | I-10                 | 3      | 1995 Grand Cherokee | 280793 |
| 10/08/05**                 | FARS (tree)         | Tishomingo Co.    | US-72                | 1      | 1999 Grand Cherokee | 280587 |
| <b>Missouri</b>            |                     |                   |                      |        |                     |        |
| 11/13/98**                 | FARS (overturn)     | Gasconade Co.     | SR-KK                | 1      | 1996 Grand Cherokee | 290877 |
| 01/23/00*†(7)              | FARS                | Platte Co.        | I-29                 | 10     | 1996 Grand Cherokee | 290069 |
| 12/03/00**                 | FARS (tree)         | Greene Co.        | SR-13                | 3      | 1995 Grand Cherokee | 290907 |
| 08/02/02*†(1)              | FARS                | Camden Co.        | SR-C                 | 1      | 1996 Grand Cherokee | 290600 |
| 09/04/02*†(1)              | FARS                | Maryland Heights  | I-270                | 1      | 1997 Grand Cherokee | 290695 |
| 11/17/02**                 | FARS (tree)         | Kansas City       | 63 <sup>rd</sup> St. | 1      | 1995 Grand Cherokee | 290923 |
| 06/05/04**                 | FARS (overturn)     | St. Louis         | Lee Ave. Fair Ave.   | 1      | 1995 Grand Cherokee | 290473 |
| 06/14/06*                  | FARS                | Kennett           | US-412               | 1      | 1997 Grand Cherokee | 290392 |
| 02/01/08*†(1)              | FARS                | Osage Co.         | US-50                | 1      | 1997 Grand Cherokee | 290069 |
| <b>Nebraska</b>            |                     |                   |                      |        |                     |        |
| 12/19/06 <sup>F</sup> †(1) | FARS                | Pierce Co.        | 553 Ave. 849 Rd.     | 1      | 2000 Grand Cherokee | 310215 |
| 06/24/08**                 | FARS (overturn)     | Dawes Co.         | Slim Buttes Rd.      | 1      | 1998 Grand Cherokee | 310085 |
| <b>Nevada</b>              |                     |                   |                      |        |                     |        |
| <b>New Hampshire</b>       |                     |                   |                      |        |                     |        |
| 07/21/00*†(1)              | FARS                | Hampton           | SR-101               | 1      | 1994 Grand Cherokee | 330066 |
| <b>New Jersey</b>          |                     |                   |                      |        |                     |        |
| 01/05/01**                 | FARS (other object) | Gloucester Co.    | Cedar Swamp Rd.      | 1      | 1996 Grand Cherokee | 340016 |

| Crash Date by State        | Name               | City/County       | Road                            | Deaths | Make/Model/Year     | FARS # |
|----------------------------|--------------------|-------------------|---------------------------------|--------|---------------------|--------|
| 09/23/05**                 | FARS (parked veh.) | Union             | I-78                            | 1      | 1998 Grand Cherokee | 340462 |
| 03/31/06*                  | FARS               | Mansfield         | US-130                          | 1      | 1999 Grand Cherokee | 340144 |
| 02/24/07 <sup>F</sup>      | FARS               | Parsippany        | I-287                           | 1      | 1996 Grand Cherokee | 340080 |
| <b>New Mexico</b>          |                    |                   |                                 |        |                     |        |
| 03/08/02*†(7)              | FARS               | Guadalupe Co.     | I-40                            | 7      | 1999 Grand Cherokee | 350350 |
| <b>New York</b>            |                    |                   |                                 |        |                     |        |
| 08/21/99 <sup>F</sup>      | FARS               | Henrietta         | I-390                           | 1      | 1996 Grand Cherokee | 360956 |
| 09/01/99*†(1)              | FARS               | Southampton       | SR-27                           | 1      | 1997 Grand Cherokee | 360720 |
| 09/02/99**                 | FARS (overturn)    | East Moriches     | SR-27                           | 1      | 1997 Grand Cherokee | 360153 |
| 12/19/02**                 | FARS (parked veh.) | Yonkers           | I-87                            | 1      | 2002 Grand Cherokee | 361116 |
| 03/14/04*†(1)              | FARS               | Wyoming Co.       | CR-13 CR-16                     | 1      | 1993 Grand Cherokee | 360170 |
| 08/14/04**†(1)             | FARS (overturn)    | Palmyra           | SR-21                           | 1      | 1994 Grand Cherokee | 360847 |
| 12/17/06 <sup>F</sup>      | FARS               | Greenfield Center | SR-9                            | 1      | 1996 Grand Cherokee | 361158 |
| 08/15/07 <sup>F</sup>      | FARS               | Duanesburg        | I-88                            | 1      | 1993 Grand Cherokee | 360655 |
| 06/19/08 <sup>F</sup>      | FARS               | Churubusco        | River Rd.                       | 1      | 2004 Grand Cherokee | 360417 |
| <b>North Carolina</b>      |                    |                   |                                 |        |                     |        |
| 12/19/99**                 | FARS (tree)        | Columbus Co.      | US-74-76                        | 1      | 1994 Grand Cherokee | 371297 |
| 03/09/02*†(2)              | FARS               | Nash Co.          | US-64                           | 2      | 1998 Grand Cherokee | 370211 |
| <b>North Dakota</b>        |                    |                   |                                 |        |                     |        |
| 07/24/06**                 | FARS (overturn)    | Stark Co.         | SR-10 114 <sup>th</sup> Ave. SW | 1      | 1993 Grand Cherokee | 380051 |
| <b>Ohio</b>                |                    |                   |                                 |        |                     |        |
| 07/30/95**                 | FARS (culvert)     | Hilliard          | Hayden Run Road                 | 1      | 1993 Grand Cherokee | 390650 |
| 09/26/97 <sup>F</sup>      | FARS               | Wood Co.          | SR65                            | 1      | 1993 Grand Cherokee | 390948 |
| 09/05/98*                  | FARS               | Delaware Co.      | US-42                           | 1      | 1996 Grand Cherokee | 390810 |
| 12/17/98*                  | FARS               | Guernsey Co.      | I-70                            | 1      | 1993 Grand Cherokee | 391178 |
| 11/23/99*†(2)              | FARS               | Tuscarawas Co.    | I-77                            | 2      | 1996 Grand Cherokee | 391139 |
| 03/24/01**                 | FARS (tree)        | Chillicothe       | Bellevue Ave.                   | 1      | 1996 Grand Cherokee | 390067 |
| 06/29/02*                  | FARS               | Sandusky Co.      | SR-600                          | 1      | 1997 Grand Cherokee | 390544 |
| 05/28/03*†(1)              | FARS               | Lawrence Co.      | SR-378                          | 1      | 1998 Grand Cherokee | 390409 |
| 11/29/03*                  | FARS               | Lakeview          | US-33                           | 1      | 1999 Grand Cherokee | 391018 |
| <b>Oklahoma</b>            |                    |                   |                                 |        |                     |        |
| 05/26/01 <sup>F</sup> †(1) | FARS               | Oklahoma City     | S. Choctaw Rd.                  | 2      | 1993 Grand Cherokee | 400185 |

| Crash Date by State   | Name               | City/County    | Road                                  | Deaths | Make/Model/Year     | FARS # |
|-----------------------|--------------------|----------------|---------------------------------------|--------|---------------------|--------|
| <b>Oregon</b>         |                    |                |                                       |        |                     |        |
| 09/22/95*             | FARS               | Grant Co.      | 5                                     | 1      | 1993 Grand Cherokee | 410353 |
| 09/20/97**            | FARS (overturn)    |                | 205/DOT440                            | 2      | 1994 Grand Cherokee | 410303 |
| <b>Pennsylvania</b>   |                    |                |                                       |        |                     |        |
| 10/24/98**            | FARS (tree)        | Franklin Co.   | I-76                                  | 2      | 1998 Grand Cherokee | 421049 |
| 03/05/00 <sup>F</sup> | FARS               | Bucks Co.      | SR-309                                | 1      | 1993 Grand Cherokee | 420157 |
| 09/21/03*†(1)         | FARS               | Clinton Co.    | SR-120                                | 2      | 1994 Grand Cherokee | 421054 |
| 02/27/04*             | FARS               | York Co.       | I-83                                  | 2      | 2000 Grand Cherokee | 420293 |
| 07/03/05**            | FARS (tree)        | Philadelphia   | SR-4013                               | 1      | 1993 Grand Cherokee | 420613 |
| 04/05/06**            | FARS (overturn)    | Clarion Co.    | Nickleville Rd.                       | 1      | 1995 Grand Cherokee | 420249 |
| 11/30/06*             | FARS               | Warren Co.     | SR-0059                               | 1      | 1995 Grand Cherokee | 421006 |
| 11/12/07*†(1)         | FARS               | Lackawanna Co. | SR-435                                | 1      | 2000 Grand Cherokee | 421144 |
| 02/16/08**            | FARS (tree)        | Erie Co.       | SR-5                                  | 1      | 2002 Grand Cherokee | 420105 |
| <b>Rhode Island</b>   |                    |                |                                       |        |                     |        |
| 07/12/02**            | FARS (tree)        | Scituate       | SR-116                                | 1      | 1998 Grand Cherokee | 440023 |
| <b>South Carolina</b> |                    |                |                                       |        |                     |        |
| 08/06/99 <sup>F</sup> | FARS               | Marlboro Co.   | 259                                   | 2      | 1993 Grand Cherokee | 450527 |
| 05/21/00 <sup>F</sup> | FARS               | Hampton        | SR-68                                 | 1      | 1994 Grand Cherokee | 450396 |
| 04/25/05*             | FARS               | Richland Co.   | I-20 SR-277                           | 1      | 1998 Grand Cherokee | 450360 |
| 07/07/08 <sup>F</sup> | FARS               | Georgetown Co. | US-17 545                             | 1      | 1996 Grand Cherokee | 450425 |
| <b>South Dakota</b>   |                    |                |                                       |        |                     |        |
| 03/23/07**            | FARS (overturn)    | Moody Co.      | SR-34                                 | 1      | 1998 Grand Cherokee | 460021 |
| <b>Tennessee</b>      |                    |                |                                       |        |                     |        |
| 08/31/01 <sup>F</sup> | FARS               | Jackson        | McClellan Rd.                         | 1      | 1999 Grand Cherokee | 470731 |
| 08/31/02 <sup>F</sup> | FARS               | Lawrence Co.   | Old Jackson Hwy.                      | 1      | 1994 Grand Cherokee | 470669 |
| 05/29/04 <sup>F</sup> | FARS               | Germantown     | Stout Rd.                             | 1      | 1996 Grand Cherokee | 471036 |
| 08/01/05**            | FARS (bridge pier) | Kingsport      | I-181                                 | 1      | 1997 Grand Cherokee | 471107 |
| 11/18/06*†(1)         | FARS               | Wilson Co.     | Saundersville Rd. Cedar Creek Village | 1      | 1998 Grand Cherokee | 471136 |
| 12/16/06**            | FARS (tree)        | Mount Juliet   | South Greenhill Rd.                   | 1      | 1999 Grand Cherokee | 470904 |
| <b>Texas</b>          |                    |                |                                       |        |                     |        |

| Crash Date by State   | Name            | City/County    | Road                      | Deaths | Make/Model/Year     | FARS # |
|-----------------------|-----------------|----------------|---------------------------|--------|---------------------|--------|
| 06/22/97*             | FARS            | Cass Co.       | 59                        | 1      | 1996 Grand Cherokee | 481932 |
| 01/16/98 <sup>F</sup> | FARS            | Brazoria Co.   | SR-288                    | 1      | 1994 Grand Cherokee | 480087 |
| 11/11/00**            | FARS (tree)     | Gonzales Co.   | SR-97                     | 1      | 1997 Grand Cherokee | 482644 |
| 06/09/04 <sup>F</sup> | FARS            | Victoria Co.   | US-77                     | 1      | 2002 Grand Cherokee | 481205 |
| 12/12/04*†(1)         | FARS            | Dallas         | I-35E                     | 1      | 1998 Grand Cherokee | 483248 |
| 08/06/05 <sup>F</sup> | FARS            | Bullard        | FM344                     | 1      | 1996 Grand Cherokee | 481685 |
| 04/28/06*             | FARS            | Dallas         | I-30                      | 2      | 2000 Grand Cherokee | 480867 |
| <b>Vermont</b>        |                 |                |                           |        |                     |        |
| 04/10/00*             | FARS            | Swanton        | I-89                      | 1      | 1998 Grand Cherokee | 500019 |
| 09/11/08*             | FARS            | Waterbury      | SR-100                    | 1      | 1998 Grand Cherokee | 500049 |
| <b>Virginia</b>       |                 |                |                           |        |                     |        |
| 08/08/03*             | FARS            | Washington Co. | SR-75                     | 1      | 1998 Grand Cherokee | 510627 |
| <b>Washington</b>     |                 |                |                           |        |                     |        |
| 03/15/06**            | FARS (tree)     | Auburn         | SR-164                    | 2      | 1995 Grand Cherokee | 530101 |
| <b>West Virginia</b>  |                 |                |                           |        |                     |        |
| 12/06/03**            | FARS (tree)     | Kanawha Co.    | US-60                     | 1      | 1994 Grand Cherokee | 540342 |
| 09/30/06 <sup>F</sup> | FARS            | Charleston     | Hickory Rd. Overbrook Rd. | 1      | 1998 Grand Cherokee | 540269 |
| <b>Wisconsin</b>      |                 |                |                           |        |                     |        |
| 05/18/03 <sup>F</sup> | FARS            | Grant Co.      | SR-133                    | 1      | 1996 Grand Cherokee | 550248 |
| 07/03/04**            | FARS (tree)     | Columbia       | Hopkins Rd.               | 1      | 1995 Grand Cherokee | 550318 |
| 07/03/07 <sup>F</sup> | FARS            | Nashotah       | SR-16                     | 1      | 2001 Grand Cherokee | 550300 |
| 09/09/07**            | FARS (overturn) | Greenfield     | I-43                      | 1      | 1994 Grand Cherokee | 550455 |
| <b>Wyoming</b>        |                 |                |                           |        |                     |        |
| 04/04/03*             | FARS            | Converse Co.   | I-25                      | 1      | 1993 Grand Cherokee | 560022 |

<sup>F</sup> Indicated in FARS as most harmful: "fire/explosion."

\* Indicated in FARS as most harmful: "motor vehicle in transport" or "motor vehicle in transport in other roadway."

\*\* Item in parentheses is most harmful event as indicated in FARS.

<sup>F-A</sup> Fire listed as cause of in autopsy report or certificate

<sup>F-L</sup> Fire indicated as cause of in litigation.

<sup>F-R</sup> Fire indicated as cause of in accident report.

† Fatality(s) (#) occurred in bullet vehicle

**Attachment B**  
**MY 1993-2008 Jeep Grand Cherokee Fatal Fire Crashes with Fire/Explosion as Most Harmful Event, 1992-2008**

**MY 1993-2008 Jeep Grand Cherokee Fatal Fire Crashes with Most Harmful Event as Fire/Explosion, 1992-2008**

This table includes known fire crashes where fire/explosion is listed as Most Harmful Event, obtained from NHTSA's Fatal Analysis Crash System (FARS) for Calendar Years 1992-2008 and from public records for other years and for crashes not listed in FARS.

| <b>Crash Date by State</b> | <b>Name</b> | <b>City/County</b> | <b>Road</b>                  | <b>Deaths</b> | <b>Make/Model/Year</b> | <b>FARS #</b> |
|----------------------------|-------------|--------------------|------------------------------|---------------|------------------------|---------------|
| <b>Alabama</b>             |             |                    |                              |               |                        |               |
| 04/12/06 <sup>F</sup>      | FARS        | Montgomery         | 5466                         | 1             | 2004 Grand Cherokee    | 10243         |
| 04/25/07 <sup>F</sup>      | FARS        | Macon Co.          | I-85                         | 1             | 1993 Grand Cherokee    | 10270         |
| <b>Arizona</b>             |             |                    |                              |               |                        |               |
| 02/01/98 <sup>F</sup>      | FARS        | Gila Co.           | Old Dripping Springs         | 1             | 1993 Grand Cherokee    | 40059         |
| 03/13/01 <sup>F</sup>      | FARS        | Mohave Co.         | I-40                         | 2             | 1994 Grand Cherokee    | 40104         |
| <b>California</b>          |             |                    |                              |               |                        |               |
| 03/16/96 <sup>F</sup> †(5) | FARS        | Carson             | 91                           | 5             | 1996 Grand Cherokee    | 60718         |
| 07/07/96 <sup>F</sup> †(1) | FARS        | Poway              | Espola Rd.                   | 1             | 1993 Grand Cherokee    | 61698         |
| 10/27/99 <sup>F</sup>      | FARS        | Los Angeles        | SR-170                       | 1             | 1998 Grand Cherokee    | 62795         |
| 05/07/00 <sup>F</sup>      | FARS        | Orange Co.         | SR-241                       | 1             | 1993 Grand Cherokee    | 60499         |
| 07/20/01 <sup>F</sup>      | FARS        | San Bernardino Co. | I-10                         | 1             | 1994 Grand Cherokee    | 61708         |
| 08/30/02 <sup>F</sup>      | FARS        | Bakersfield        | SR-58                        | 1             | 1993 Grand Cherokee    | 62653         |
| 08/18/05 <sup>F</sup>      | FARS        | Oceanside          | Vista Way                    | 1             | 1994 Grand Cherokee    | 63236         |
| 05/24/06 <sup>F</sup> †(1) | FARS        | Orange Co.         | SR-241                       | 2             | 2001 Grand Cherokee    | 61349         |
| <b>Colorado</b>            |             |                    |                              |               |                        |               |
| 01/10/05 <sup>F</sup>      | FARS        | Mesa Co.           | Rim Rock Dr.                 | 1             | 2004 Grand Cherokee    | 80025         |
| <b>Florida</b>             |             |                    |                              |               |                        |               |
| 09/05/07 <sup>F</sup>      | FARS        | N/A                | SR-944 32 <sup>nd</sup> Ave. | 2             | 1998 Grand Cherokee    | 122577        |
| <b>Georgia</b>             |             |                    |                              |               |                        |               |
| 03/08/05 <sup>F</sup>      | FARS        | Paulding Co.       | N/A                          | 1             | 1999 Grand Cherokee    | 130196        |
| 03/09/05 <sup>F</sup>      | FARS        | Macon Co.          | SR-49                        | 1             | 1997 Grand Cherokee    | 130197        |
| <b>Illinois</b>            |             |                    |                              |               |                        |               |
| 09/04/00 <sup>F</sup>      | FARS        | Chicago            | I-90/94                      | 6             | 1993 Grand Cherokee    | 170827        |
| 10/16/07 <sup>F</sup>      | FARS        | La Salle Co.       | I-39                         | 2             | 1993 Grand Cherokee    | 170830        |
| <b>Indiana</b>             |             |                    |                              |               |                        |               |
| 09/16/04 <sup>F</sup>      | FARS        | Warrick Co.        | I-64                         | 1             | 2004 Grand Cherokee    | 180705        |
| 11/13/04 <sup>F</sup>      | FARS        | Noble Co.          | US-33                        | 4             | 1997 Grand Cherokee    | 180723        |
| <b>Kentucky</b>            |             |                    |                              |               |                        |               |
| 02/13/00 <sup>F</sup>      | FARS        | Bourbon Co.        | Vemont Ln.                   | 1             | 1997 Grand Cherokee    | 210052        |



| <b>Crash Date by State</b> | <b>Name</b> | <b>City/County</b> | <b>Road</b>      | <b>Deaths</b> | <b>Make/Model/Year</b> | <b>FARS #</b> |
|----------------------------|-------------|--------------------|------------------|---------------|------------------------|---------------|
| <b>Louisiana</b>           |             |                    |                  |               |                        |               |
| 07/20/03 <sup>F</sup> †(3) | FARS        | St. Martin Co.     | I-10             | 5             | 2000 Grand Cherokee    | 220401        |
| <b>Michigan</b>            |             |                    |                  |               |                        |               |
| 04/30/05 <sup>F</sup> †(1) | FARS        | Oakland Co.        | I-75             | 3             | 2004 Grand Cherokee    | 260239        |
| <b>Nebraska</b>            |             |                    |                  |               |                        |               |
| 12/19/06 <sup>F</sup> †(1) | FARS        | Pierce Co.         | 553 Ave. 849 Rd. | 1             | 2000 Grand Cherokee    | 310215        |
| <b>New Jersey</b>          |             |                    |                  |               |                        |               |
| 02/24/07 <sup>F</sup>      | FARS        | Parsippany         | I-287            | 1             | 1996 Grand Cherokee    | 340080        |
| <b>New York</b>            |             |                    |                  |               |                        |               |
| 08/21/99 <sup>F</sup>      | FARS        | Henrietta          | I-390            | 1             | 1996 Grand Cherokee    | 360956        |
| 12/17/06 <sup>F</sup>      | FARS        | Greenfield Center  | SR-9             | 1             | 1996 Grand Cherokee    | 361158        |
| 08/15/07 <sup>F</sup>      | FARS        | Duanesburg         | I-88             | 1             | 1993 Grand Cherokee    | 360655        |
| 06/19/08 <sup>F</sup>      | FARS        | Churubusco         | River Rd.        | 1             | 2004 Grand Cherokee    | 360417        |
| <b>Ohio</b>                |             |                    |                  |               |                        |               |
| 09/26/97 <sup>F</sup>      | FARS        | Wood Co.           | SR65             | 1             | 1993 Grand Cherokee    | 390948        |
| <b>Oklahoma</b>            |             |                    |                  |               |                        |               |
| 05/26/01 <sup>F</sup> †(1) | FARS        | Oklahoma City      | S. Choctaw Rd.   | 2             | 1993 Grand Cherokee    | 400185        |
| <b>Pennsylvania</b>        |             |                    |                  |               |                        |               |
| 03/05/00 <sup>F</sup>      | FARS        | Bucks Co.          | SR-309           | 1             | 1993 Grand Cherokee    | 420157        |
| <b>South Carolina</b>      |             |                    |                  |               |                        |               |
| 08/06/99 <sup>F</sup>      | FARS        | Marlboro Co.       | 259              | 2             | 1993 Grand Cherokee    | 450527        |
| 05/21/00 <sup>F</sup>      | FARS        | Hampton            | SR-68            | 1             | 1994 Grand Cherokee    | 450396        |
| 07/07/08 <sup>F</sup>      | FARS        | Georgetown Co.     | US-17 545        | 1             | 1996 Grand Cherokee    | 450425        |
| <b>Tennessee</b>           |             |                    |                  |               |                        |               |
| 08/31/01 <sup>F</sup>      | FARS        | Jackson            | McClellan Rd.    | 1             | 1999 Grand Cherokee    | 470731        |
| 08/31/02 <sup>F</sup>      | FARS        | Lawrence Co.       | Old Jackson Hwy. | 1             | 1994 Grand Cherokee    | 470669        |
| 05/29/04 <sup>F</sup>      | FARS        | Germantown         | Stout Rd.        | 1             | 1996 Grand Cherokee    | 471036        |
| <b>Texas</b>               |             |                    |                  |               |                        |               |

| <b>Crash Date by State</b> | <b>Name</b> | <b>City/County</b> | <b>Road</b>               | <b>Deaths</b> | <b>Make/Model/Year</b> | <b>FARS #</b> |
|----------------------------|-------------|--------------------|---------------------------|---------------|------------------------|---------------|
| 01/16/98 <sup>F</sup>      | FARS        | Brazoria Co.       | SR-288                    | 1             | 1994 Grand Cherokee    | 480087        |
| 06/09/04 <sup>F</sup>      | FARS        | Victoria Co.       | US-77                     | 1             | 2002 Grand Cherokee    | 481205        |
| 08/06/05 <sup>F</sup>      | FARS        | Bullard            | FM344                     | 1             | 1996 Grand Cherokee    | 481685        |
| <b>West Virginia</b>       |             |                    |                           |               |                        |               |
| 09/30/06 <sup>F</sup>      | FARS        | Charleston         | Hickory Rd. Overbrook Rd. | 1             | 1998 Grand Cherokee    | 540269        |
| <b>Wisconsin</b>           |             |                    |                           |               |                        |               |
| 05/18/03 <sup>F</sup>      | FARS        | Grant Co.          | SR-133                    | 1             | 1996 Grand Cherokee    | 550248        |
| 07/03/07 <sup>F</sup>      | FARS        | Nashotah           | SR-16                     | 1             | 2001 Grand Cherokee    | 550300        |
|                            |             |                    |                           | <b>68</b>     |                        |               |

<sup>F</sup> Indicated in FARS as most harmful: "fire/explosion."

† Fatality(s) (#) occurred in other vehicle(s).

**Attachment C**  
**Ford Pinto Investigation Report**

INVESTIGATION REPORT

PHASE I

C7 - 38

ALLEGED FUEL TANK AND FILLER NECK DAMAGE IN REAR-END  
COLLISION OF SUBCOMPACT PASSENGER CARS

1971 - 1976 FORD PINTO  
1975 - 1976 MERCURY BOBCAT

OFFICE OF DEFECTS INVESTIGATION  
ENFORCEMENT  
NATIONAL HIGHWAY TRAFFIC SAFETY ADMINISTRATION

MAY 1978

A PORTION OF THIS REPORT HAS BEEN WITHHELD  
FROM THE PUBLIC FILE PURSUANT TO 5 U.S.C.  
552(b)(4).

**OFFICIAL USE  
ONLY**

7 38-81

## TABLE OF CONTENTS

|   | <u>Page</u> |
|---|-------------|
| I. BACKGROUND                                     | 1           |
| A. BASIS FOR INVESTIGATION                        | 1           |
| B. DESCRIPTION AND FUNCTION                       | 1           |
| C. ANALYSIS OF THE ALLEGED PROBLEM                | 1           |
| Mode  | 1           |
| Symptoms  | 2           |
| D. INVESTIGATIVE INPUTS AND ACTIONS               | 2           |
| II. PROBLEMS ALLEGED                              | 3           |
| A. REPORTS FROM CONSUMERS                         | 3           |
| B. REPORTS FROM FORD MOTOR COMPANY                | 3           |
| C. REPORTS FROM CANADIAN MINISTRY OF TRANSPORT    | 4           |
| D. SUMMARY OF PROBLEM REPORTS                     | 4           |
| III. TECHNICAL DATA                               | 5           |
| IV. MAJOR NHTSA INVESTIGATIVE ACTIONS             | 9           |
| A. EXAMINATION OF ACCIDENT STATISTICS             | 9           |
| B. NHTSA CRASH TEST PROGRAM                       | 11          |
| V. OTHER NHTSA ACTIONS                            | 13          |
| A. MEDIA AND CONSUMER GROUPS                      | 13          |
| B. RECORD CHECKS                                  | 13          |
| 1. Vehicle Owner Letter File                      | 13          |
| 2. NHTSA Motor Vehicle Defect Recall Campaign Log | 13          |
| 3. Technical Reference Library                    | 14          |
| 4. Canadian Ministry of Transport                 | 14          |
| VI. OBSERVATIONS                                  | 15          |
| VII. CONCLUSIONS                                  | 16          |

## I. BACKGROUND

1.

### A. BASIS FOR INVESTIGATION:

A formal defect investigation case was initiated on September 13, 1977, based upon allegations that the design and location of the fuel tank in the Ford Pinto make it highly susceptible to damage on rear impact at low to moderate closing speeds.

On August 10, 1977, a press conference was held in Washington, D.C., to announce the release of an article entitled, "Pinto Madness", which was published in the September/October issue of Mother Jones magazine. The article made several allegations concerning the safety of the Pinto fuel tank. The most significant of these charges as related to the National Highway Traffic Safety Administration's (NHTSA) defect investigation are as follows:

1. That the Pinto fuel tank is designed and located so that in rear-impact collisions at low to moderate speeds, it is displaced forward until it impacts the differential housing on the rear axle, resulting in tank cuts and/or puncture. The leakage of gasoline thus presents a significant fire hazard.
2. That the Ford Motor Company had knowledge of this "defect" during the developmental phase of the Pinto through its own test programs, but concluded that it was more cost-effective to produce the vehicle without modifications which would have corrected the problem but added to the production cost.

Investigation was initiated to determine whether the alleged problem constitutes a safety-related defect within the meaning of the National Traffic and Motor Vehicle Safety Act of 1966.

### B. DESCRIPTION AND FUNCTION:

The Pinto fuel tank is of sheet metal construction and is attached to the undercarriage of the vehicle by means of two metal straps. In addition, the fuel filler tube extends into the top left side of the tank in a sliding fit through a gasketed opening. At its other end the fuel filler tube is affixed to the inner side of the left rear quarter panel by means of a bracket which is firmly attached to the quarter panel surface.

The fuel tank is the reservoir which holds the supply of gasoline required for engine operation. In the Pinto and Bobcat of model years in question, the tank capacity is approximately 11 gallons.

### C. ANALYSIS OF THE ALLEGED PROBLEM:

MODE:

Allegedly, rear impact of the Pinto by another vehicle at low to moderate closing speed displaces the fuel tank forward until it is cut or punctured

2.

by the differential housing, or its bolts. Fuel tank filler necks pull out of the tank as well. The resulting fuel spillage may then be ignited, creating a fire hazard of obvious significance.

SYMPTOMS:

There are no symptoms to indicate the existence of the alleged safety hazard. The alleged problem addresses the rear impact crashworthiness of the Pinto and Bobcat which is exhibited only under collision conditions.

D. INVESTIGATIVE INPUTS AND ACTIONS:

Following public release of the article, "Pinto Madness", the NHTSA initiated, on August 11, 1977, a preliminary evaluation of the alleged safety defect, and on September 13, a formal defect investigation case. The following activities were undertaken in these efforts.

- A. The author of the magazine article, Mark Dowie, was asked to make available to the NHTSA, documentation and evidence upon which his article was based.
- B. Consumer letters, including Congressional inquiries on behalf of constituents, were received and appropriately processed.
- C. The National Center for Statistics and Analysis conducted a search of the Fatal Accident Reporting System (FARS) files, to compile relevant fatal accident statistics and data.
- D. The Ford Motor Company was requested to provide various technical and legal data concerning the matter.
- E. Contact was established and maintained with the Canadian Ministry of Transport (CMOT), which also initiated an investigation of the "Pinto Madness" charges.
- F. A test program of staged vehicle-to-vehicle rear-end collisions was developed and a contract awarded for the performance of these tests.

The details of the aforementioned sources of information, as well as NHTSA actions taken and the findings which resulted, are detailed in subsequent sections of this report.

## II. PROBLEMS ALLEGED

### A. REPORTS FROM CONSUMERS:

Since public release of the Mother Jones article, the NHTSA has received over 900 inquiries from the public concerning this matter. The defect investigation case file contains 54 letters and telephone contacts, including 18 Congressional inquiries on behalf of constituents. The Office of Public Affairs and Consumer Participation has received approximately 540 inquiries from Pinto and other vehicle owners concerning this matter, in addition to an estimated 30 inquiries from the media, and several inquiries from various consumer groups. The Auto Safety Hotline reported that an estimated 250 telephone inquiries have been received with no further contacts made with these consumers. In addition, over 40 telephone contacts have been made by ODI Staff personnel with various consumers, media representatives and with NHTSA representatives in Regional Offices. These contacts were generally non-contributory to the investigation in terms of furnishing factual data, and are not documented in the record.

Of the consumer letters and other inquiries, only one involved an actual report of a fire occurrence in a Pinto vehicle upon rear-end impact, not previously reported to the NHTSA through other sources. This particular instance involved a parked Pinto sedan of unknown model year which was rear-ended by a 1969 Pontiac Firebird in a residential area. The incident resulted in fire damage to both the Pinto and other real property, but no bodily injuries and/or fatalities were sustained.

### B. REPORTS FROM FORD MOTOR COMPANY (FORD):

In response to the NHTSA's requests, Ford provided information concerning the number and nature of known incidents in which rear impact of a Pinto vehicle reportedly caused fuel tank damage, fuel system leakage or fire occurrence. This information disclosed the following:

Total Number Rear Impact/Fuel Leakage/Fire cases reported: 35  
Lawsuits/Liability Claims: 29

Total Number injuries, including fatalities, reported in all vehicles: 107

Total Number injuries, including fatalities, sustained by Pinto occupants: 57

Total Number fatalities reported: 26

Number fatalities sustained by Pinto occupants: 25

Lawsuits/Liability Claims: 29  
(Cases involving fires/burn injuries or claims of defective/dangerous fuel tank/negligence in fuel system design)

Number burn injuries: 23

Number fatalities reported (non-impact): 21



Number cases settled out of court or by judgement against Ford/defendants: 8

Number cases pending trial: 19

Cases settled in favor of Ford/under investigation: 2

C. REPORTS FROM CANADIAN MINISTRY OF TRANSPORT (CMOT):

Since the initiation of this defect investigation case, two incidents have been reported to the NHTSA by the CMOT, involving rear-impact collisions of Ford Pintos which resulted in fires. These incidents resulted in one fatality, and two impact/burn injury cases.

D. SUMMARY OF PROBLEM REPORTS:

In total, the NHTSA is aware of 38 cases in which rear-end collisions of Pinto vehicles have resulted in fuel tank damage, fuel system leakage and/or ensuing fire. These cases have resulted in a total of 27 fatalities sustained by Pinto occupants, of which one is reported to have resulted from impact injuries. In addition, 24 occupants of these Pinto vehicles have sustained non-fatal burn injuries.

### III. TECHNICAL DATA

The following technical data acquired from Ford and other sources has relevance to the design, materials, construction or performance aspect of the fuel tank installed in the 1971-1976 Pinto and 1975-1976 Bobcat.

1. The Pinto two-door sedan was introduced for sale in the United States on September 11, 1970, as a 1971 model year vehicle. A 1971 model year Pinto three-door version was introduced in February 1971. The station wagon model was introduced as a 1972 model year vehicle on March 17, 1972.
2. Production statistics for the pre-1977 Pinto are as follows:

| Model Year | 2-Door<br>Sedan | 3-Door<br>Sedan | Station<br>Wagon | Totals         |
|------------|-----------------|-----------------|------------------|----------------|
| 1971       | 267,694         | 59,173          | 0                | 326,867        |
| 1972       | 171,616         | 187,657         | 96,221           | 455,494        |
| 1973       | 109,080         | 141,440         | 204,514          | 455,034        |
| 1974       | 120,911         | 159,999         | 217,351          | 498,261        |
| 1975       | 58,697          | 63,129          | 83,137           | 204,963        |
| 1976       | <u>86,842</u>   | <u>87,101</u>   | <u>99,138</u>    | <u>273,081</u> |
| Totals     | 814,840         | 698,499         | 700,361          | 2,213,700      |

3. Based upon R.L. Polk and Company statistics of vehicle registration as of July 1, 1976, it is estimated that 1.9 million Pintos of 1971-1976 model years are currently in use. These Pinto vehicles accounted for 2.0% of all registered cars as of July 1, 1976.
4. The 1971-1976 Pinto fuel tank is of sheet steel construction and is attached to the vehicle's rear undercarriage by two metal straps, with mounting brackets. The tank is located aft of the rear axle which, in the Pinto, may be one of two types; 6 3/4 - inch ring gear with integral carrier, or 8 - inch ring gear with removeable carrier. The rear differential cover on the 8 - inch axle is welded on, and employs no mechanical fasteners. The 6 3/4 - inch axle differential cover is attached by eight 5/16 - 18x0.62 hex head locking screws. The differential cover dome protrudes further aft than do the the screw heads, as follows:

|                                   | <u>Height of Fastener<br/>Head Relative to<br/>Adjacent Cover</u> | <u>Distance of Fastener<br/>Head <u>Forward</u> of Cover<br/>Dome Surface</u> |
|-----------------------------------|---|---|
| S.O.P. 1971 -                     | .314/.246   | 1.954/1.827   |
| Approx. 3/71 -<br>Model Year 1977 | .313/.293   | 1.907/1.827   |

The outer edge of the differential cover dome also protrudes aft approximately 1/8 - inch, the apparent result of the dome forming process.

In answering NHTSA questions, Ford provided information concerning nominal distances from the forward surface of the fuel tank to the aft surface of the differential cover. While the true distance from the fuel tank body to the nearest point on the rear axle varies from one model year to another and from sedan to station wagon models, the 1971-1976 Pinto with the 6 3/4 - inch axle maintained this distance at approximately 3 inches. In the 1977 model year, this distance was increased by a minimum of 1 inch. It was also disclosed that the left shock absorber is located approximately equidistant from the fuel tank as the rear axle.

In this investigation, the fuel filler neck is considered to be an integral part of the tank. The filler neck is firmly attached by a flange with mounting screws, to the inner side of the left rear quarter panel. At its other end, the filler neck extends into the fuel tank through a gasketed opening in the left side of the tank.

Ford initiated 82 post-introduction engineering changes in the Pinto fuel tank, fuel filler neck, and associated hardware utilized for attaching the fuel tank to the vehicle underbody. Review of these data disclosed the following changes with potential relevance to the rear-impact crash performance of the fuel tank.

- . 1973 Station Wagon filler pipe - length of fuel filler pipe reduced by 0.50 inches at tank attachment end. Initiated at Job #1.
  - . 1977 Sedan and Station Wagon fuel tank shield - plastic shield added between fuel tank and straps. Initiated at Job #1.
  - . 1977 Sedan filler pipe assembly - filler pipe assembly lengthened to reduce fuel capacity by 1.3 gallons and vehicle weight by 8 pounds.
  - . Other engineering changes involved various items including tank capacity, filler pipe flange and seals, and tank straps and brackets.
5. According to Ford, Mercury Bobcat vehicles "... utilize essentially the same structures as Pintos of contemporary manufacture and their fuel systems and related components are identical to those employed in such Pintos."

Production statistics for the pre-1977 Mercury Bobcat are as follows:

| Model Year | 3-Door Runabout | Station Wagon | Totals        |
|------------|-----------------|---------------|---------------|
| 1975       | 14,605          | 17,851        | 32,456        |
| 1976       | <u>20,212</u>   | <u>21,207</u> | <u>41,419</u> |
| Totals     | 34,817          | 39,058        | 73,875        |

6. Prior to initial introduction of the Pinto for sale, Ford performed four rear impact barrier crash tests which included "...assessment of the post-impact condition of the fuel tank and/or filler pipe." These tests were reportedly conducted on "...experimental vehicles equipped with differing rear structure and fuel system designs proposed from time to time for incorporation in the Pinto..." Ford further reported that "...none of the tested vehicles employed structure or fuel system designs representative of structures and fuel systems incorporated in the Pinto as introduced in September 1970." These tests were conducted May 1969 through November 1969, utilizing a vehicle identified as a "Special Maverick."

Following initial introduction of the Pinto for sale, Ford continued a program of rear barrier impact tests on Pintos which included assessment of the post impact condition of the fuel tank and/or filler pipe. Reports of 55 rear barrier crash tests conducted "... on both production vehicles and vehicles with experimental components and/or modified structures..." were provided, including tests of Mercury Bobcats. While these tests were reportedly performed, in part, in connection with proposed NHTSA rulemaking activities, three items developed a history of consistent results:

- a. At impact speeds as low as 21.5 miles per hour with a fixed barrier (Crash Test No. 1616), the fuel tank was punctured by contact with the differential housing and/or its bolts, or with some other underbody structure.
- b. Under similar test conditions as (a), above, the fuel filler neck was pulled out of the tank completely.
- c. Again, under similar test conditions as (a), above, structural and/or sheet metal damage to the vehicle was sufficient to jam one, or both of the passenger doors closed.

Among the experimental and other modifications studied in these tests were:

- . Use of rubber bladder with locally reinforced textured nylon patches in "puncture prone areas", installed inside steel tank

- . Modification of filler pipe attachment to the left rear quarter panel and fuel tank to prevent pull-out during impact.
- . Installation of plastic shields on the fuel tank immediately aft of the differential housing.
- . Modified exhaust system with muffler located behind the rear axle.
- . Fuel tank made of molded polyethylene.
- . Increased length of fuel filler neck extending inside the tank.
- . Modified rear underbody structure and reinforced rear quarter panels.

Review of the test reports in question suggested that Ford had studied several alternative solutions to the numerous instances in which fuel tank deformation, damage or leakage occurred during or after impact.



#### IV. MAJOR NHTSA INVESTIGATIVE ACTIONS

##### A. EXAMINATION OF ACCIDENT STATISTICS:

A search of the NHTSA's Fatal Accident Reporting System (FARS) file was conducted by the National Center for Statistics and Analysis, Research and Development. Search of the automated FARS file provided information on fatal accidents for approximately 2 1/2 years of data collection. A purpose of the search was to determine whether Pintos had been involved in rear-end fatal crashes with fires.

In terms of the purely quantitative data, the following tabulations specifically applicable to the Pinto were disclosed by the FARS examination (covering 1975, 1976 and approximately half of 1977):

|  |       |
|--|-------|
| . Total Number Fatal Pinto Accidents<br>Due to All Causes, 1975-1977                               | 1,626 |
| . Total Number Pinto Occupant Fatalities in<br>Accidents Due to All Causes, 1975-1977              | 1,417 |
| . Total Number Fatal Pinto Accidents with<br>Fire, 1975-1977                                       | 33    |
| . Total Number Pinto Occupant Fatalities in<br>Accidents with Fire, 1975-1977                      | 41    |
| . Total Number Fatal Pinto Accidents with<br>Rear End Collision, 1975-1977                         | 95    |
| . Total Number Pinto Occupant Fatalities in<br>Accidents with Rear End Collision,<br>1975-1977     | 72    |
| . Total Number Fatal Pinto Accidents with<br>Rear End Collision and Fire, 1975-1977                | 11    |
| . Total Number Pinto Occupant Fatalities<br>in Accidents Rear End Collision and<br>Fire, 1975-1977 | 17    |

The data show that rear-end collisions of Pinto vehicles have resulted in fires and fatalities. This fact is substantiated by the historical details of various litigation cases.

## VII. CONCLUSIONS

Based upon the information either developed or acquired during this investigation, the following conclusions have been reached:

1. 1971-1976 Ford Pintos have experienced moderate speed, rear-end collisions that have resulted in fuel tank damage, fuel leakage, and fire occurrences that have resulted in fatalities and non-fatal burn injuries.
2. Rear-end collision of Pinto vehicles can result in puncture and other damage of the fuel tank and filler neck, creating substantial fuel leakage, and in the presence of external ignition sources fires can result.
3. The dynamics of fuel spillage are such that when impacted by a full size vehicle, the 1971-1976 Pinto exhibits a "fire threshold" at closing speeds between 30 and 35 miles per hour.
4. Relevant product liability litigation and previous recall campaigns further establish that fuel leakage is a significant hazard to motor vehicle safety, including such leakage which results from the crashworthiness characteristics of the vehicle.
5. The fuel tank design and structural characteristics of the 1975-1976 Mercury Bobcat which render it identical to contemporary Pinto vehicles, also render it subject to like consequences in rear impact collisions.

## B. NHTSA CRASH TEST PROGRAM

On September 30, 1977, a Request for Proposals was issued in order to select a contractor to perform a series of staged vehicle-to-vehicle crash tests at moderate speeds. The program was designed to generate data and to document the results of specified rear impact collisions under actual driving conditions. The stationary vehicles were specified as Pintos, Chevrolet Vegas, and full size sedans, with the moving vehicles to be identical full size sedans. The program required that the fuel tanks of the stationary vehicles be filled to at least 95% of rated capacity, and that the engines of both stationary and moving vehicles be running and at normal operating temperature at the time of impact. In addition, the brake lights were illuminated on the stationary vehicle at impact. Other test variables included:

- . Speed and attitude of the moving vehicle
- . Illumination of headlights on the moving vehicle
- . Angle and parallelism of vehicles at impact

The contract was awarded to Dynamic Science, Incorporated, in Phoenix, Arizona, and testing commenced on February 1, 1978. As originally designed, the test program involved 6 Pintos, 6 Vegas, and 3 full size vehicles for use as stationary cars. The program was subsequently amended to include 4 Pintos of 1974-1976 model years and 2 Pinto Station Wagons. Other changes in test requirements were made as the program progressed; these are identified in the matrix of test results attached as Figure 2, to this report. In its final form, the program entailed:

### 11 Full size vehicles/Pinto tests

1 Pinto/fixed barrier test (tank filled with Stoddard solvent)

5 Full size vehicle/Vega tests

1 Vega/fixed barrier test (tank filled with Stoddard solvent)

1 Full size vehicle/Full size vehicle test

19 Total tests

The results of the tests are summarized in Figure 1. Therein, it is noted that in two Pinto tests with the full size vehicle travelling at 35 miles per hour, fires resulted. In similar tests at 30 miles per hour, significant leakage of the Pinto fuel tanks resulted without fire. A significant finding in the test program was the fact that the design of the Pinto fuel filler pipe resulted in its being completely dislodged from the tank in some cases. Impacts sufficient to result in puncture/tearing of the



fuel tank generally resulted in leakage of fuel in a pouring fashion. Separation of the filler neck from the tank provided a fuel spillage mechanism in a wide dispersion fashion.

No fires were produced by the tests involving Vegas and full size vehicles as stationary cars.

All of the tests were documented by high-speed and normal speed color motion pictures, as well as by still photography following impacts.

## V. OTHER NHTSA ACTIONS

The following are other actions taken by the NHTSA.

### A. MEDIA AND CONSUMER GROUPS:

On August 11, 1977, the first of several letters was sent to Mr. Mark Dowie, author of the Mother Jones article, requesting that he make available to the NHTSA, documentation and evidence upon which his article was based.

Because of the sensitivity and widespread media attention given to the Mother Jones article, as well as to the settlements of two related lawsuits during the course of this investigation, specific requests to various media and consumer organizations for information were generally not made. Efforts were expended, however, in cooperating with the media and consumer groups to advise them of the nature, scope and status of the NHTSA's investigation. Included among the organizations contacted were the Center for Auto Safety, ABC-TV Evening News, and various television stations and newspapers.

### B. RECORDS CHECKS:

#### 1. Vehicle Owner Letter File

The NHTSA's motor vehicle owner letter file, initiated in September 1966, contains all letters and telephone contacts received from all sources reporting defects and other problems with motor vehicles. At present, approximately 2,500 documents enter this file each month.

All letters received by the NHTSA in specific reference to this investigation were noted in Section II.A., of this report.

#### 2. NHTSA Motor Vehicle Defect Recall Campaign Log

The log contains the make, model, year and a brief description of the defect for all safety defect recall campaigns reported to the NHTSA by manufacturers in accordance with the Act of 1966.

A check of the Campaign Log disclosed that at least 17 previous recalls have been conducted for correction of various specific problems that could allow fuel leakage from the fuel tank/filler neck/cap. Of note is Campaign No. 77V048, in which General Motors recalled 128,700 1968-1970 Opel Kadetts for correction of an uncovered tail-light mounting bolt which could puncture the fuel tank in low speed right rear impacts.

In Campaign No. 77V114, the Ford Motor Company recalled 642 1977 Pintos for replacement of an erroneously installed U-nut on the inboard rear attachment of the rear bumper isolator. The edge of the U-bolt could possibly contact and puncture the fuel tank.

### 3. Technical Reference Library

A search of the Technical Reference Library filed was conducted for information and publications relevant to this investigation. This search disclosed that previously cited Pinto recall campaign (77V114), as well as three others which could involve possible fuel leakage and fire potential.

A review of all Pinto Standards Enforcement Tests disclosed that a 1976 Pinto Pony MPG failed to meet the requirements of FMVSS 301, Fuel Systems Integrity.

### 4. Canadian Ministry of Transport (CMOT)

On September 30, 1977, a 1974 Pinto was involved in a rear-impact, fatal fire accident in Windsor, Ontario, Canada. The Pinto was impacted by a 1976 Chevrolet Impala in a braking attitude and forced into the rear of a 1976 Mercury Monarch. The fuel tank of the Pinto was punctured or torn in several locations, the filler neck pulled out completely, and the vehicle was completely engulfed by fire. One of the two Pinto occupants sustained fatal injuries.

The CMOT acquired possession of the Pinto and performed a thorough inspection of the vehicle on November 29 and 30. This inspection was attended by NHTSA and Ford representatives.

On February 24, 1978, the CMOT reported the occurrence of a rear impact with fire incident involving a 1973 Pinto. The single Pinto occupant was attempting engine repairs when the vehicle was struck by a 1976 Plymouth Volare reportedly travelling at 35 miles per hour. A report of the incident, with photographs taken within seconds after the collision by a nearby pedestrian, was furnished to the NHTSA on March 30, 1978.

## VI. OBSERVATIONS

The fuel tank and filler pipe assembly installed in the 1971-1976 Ford Pinto is subject to damage which results in fuel spillage and fire potential in rear impact collisions by other vehicles at moderate closing speeds.

When impacted from the rear by other vehicles at moderate closing speeds, the Pinto fuel tank may be punctured, cut or torn, by contact with the rear axle differential housing assembly, the left shock absorber and/or its lower bracket, or by other vehicle rear underbody components.

In nine staged collision tests of 1971-1976 Pinto 2-door sedans and 3-door runabouts impacted by 1971 Chevrolet Impalas at closing speeds of 30 and 35 miles per hour, two tests resulted in fires. In all of the remaining seven tests, fuel tank damage occurred with fuel leakage rates ranging from 6 to 700 ounces per minute, with an average rate in excess of 240 ounces per minute.

In one test of a 1972 Pinto towed rearward into a fixed barrier at 21.5 miles per hour, the fuel tank sustained damage and the filler pipe pulled out of the tank. Fuel leakage was measured to exceed 12 ounces per minute.

In tests of 1 ea., 1972 and 1976 Pinto station wagons, no significant fuel leakage rates were measured. Similarly, no punctures or tears of the fuel tanks were caused, and the fuel filler pipes did not completely pull out of the tanks.

Data from the Ford Motor Company indicates that at least 35 rear-end collisions of 1971-1976 Pintos have occurred in the United States, in which fuel tank damage and/or fuel leakage and/or fires have resulted. These incidents have resulted in at least 25 fatalities and 23 cases of non-fatal burn injuries.

Data from the Fatal Accident Reporting System disclosed that from January 1975 through approximately June 1977, 33 fatal Pinto accidents occurred that involved fire, and resulted in 41 Pinto occupant fatalities. During this same period of time, 11 fatal accidents occurred in which Pintos were impacted from the rear and fires resulted; 17 Pinto occupants sustained fatal injuries in these cases.

Since initiation of this investigation, two cases have occurred in Canada involving rear impact of Pintos which resulted in fuel tank fires. These occurrences resulted in 1 fatality and 1 burn injury case.

In the history of product liability actions filed against Ford and other co-defendants involving rear impact of Pintos with fuel tank damage/fuel leakage/fire occurrences, nine cases have been settled. Of these, the plaintiffs have been compensated in 8 cases, either by jury awards or out of court settlements.

These data were recognized to be subject to qualifications and amplifications. Basically pertinent among these are the following:

- . Make/model information in FARS comes from two sources: vehicle registration data and automated decoding of the Vehicle Identification Number. Therefore, a particular car was identified where either one of these two sources indicated it to be the make/model in question.
- . Fire/explosion is not a standard data element on most police reporting forms, unless a non-collision fire caused an accident. Thus, FARS coding of fire is due primarily to its specific mention, if any, in the officer's accident description. In addition, FARS data do not indicate the origin of the fire.
- . If a death due to burns occurred sometime after the crash, it is less likely that it would be reported on the officer's accident report.
- . FARS does not record the cause of death, only its fact; it does not distinguish between deaths due to impact and those caused by the fire.
- . The FARS cases examined disclosed limited availability of data necessary to establish accurate pre-impact closing speeds.

**Attachment D**  
**Fire Safety Performance of Motor Vehicles in Crashes**



## FIRE SAFETY PERFORMANCE OF MOTOR VEHICLES IN CRASHES

**Kennerly H. Digges<sup>1</sup>**  
**R. Rhoads Stephenson<sup>1</sup>**  
**Paul G. Bedewi<sup>2</sup>**

<sup>1</sup>Motor Vehicle Fire Research Institute (MVFRI)  
<sup>2</sup>FHWA/NHTSA National Crash Analysis Center –  
The George Washington University  
USA  
Paper Number 422

### ABSTRACT

The research reported in this paper is a follow-on to a five year research program conducted by General Motors in accordance with an administrative Settlement Agreement reached with the US Department of Transportation. In lieu of a vehicle recall to reduce vehicle vulnerability to post-crash fires, a research program was undertaken to provide knowledge to assist reducing the fire vulnerability for all future vehicles.

In this follow-on research project, GM agreed fund more than \$4.1 million in fire related research over the period 2001-2004. This paper summarizes the projects undertaken and the preliminary results.

Research projects that have been initiated include the following: (1) statistical analysis of field data; (2) assessment of state-of-the-art in fuel safety technology; (3) test and evaluation of fuel tanks exposed to fire and impact; (4) development of recommended practices for the fire safety of 42-volt electrical systems.

For the year 2001, there were a total of 1,657 fatal crashes in which there was a fire. This is about 2.9% of all fatal crashes. Analysis of FARS data indicates that the fire rates in cars has dropped by 43.7% and LTVs (pick-ups, vans and SUVs) by 59.7% since the 1979. In 2000, the fire rate for passenger cars was 5.14 fires/million vehicle years, compared to 6.39 for light trucks.

For the years 1997-2000 the NASS/CDS contains 228 cases with fires. In these cases, frontal crashes accounted for 51.3% followed by rollover (24.1%) and side (18.4). Rear impacts accounted for the smallest fraction – 6.1%. The most frequent origin for the fire was the engine compartment, accounting for 64.5%. The fuel tank accounted for 11.4%. There were a relatively large number of unknown sources – 17.1%. The most frequent object impacted before the fire occurred was another vehicle (41.2%). However, a variety of roadside objects made up

48.7%. Narrow objects such as poles and trees contributed more than 25%.

Plastic tanks of three different shapes were evaluated to fire and impact testing as required by ECE R34, Annex 5 and US CFR 393.67 (e)(1). The ECE R34 fire test appeared to produce repeatable results and all tanks demonstrated the capability to withstand the test. All tanks passed the ECE R34 impact test. The US CFR 393.67 (e)(1) requires the tank containing water equal to its rated weight of fuel to be dropped on its corner from a height of 30 ft. All new tanks passed the test. However, two of three tanks that had been in service for three years failed the test.

Research is now underway to identify state-of-the-art technologies in present day motor vehicles. Other research is oriented to developing test methods to assure the fire safety of materials used in vehicles with 42-volt electrical systems. The results of this research will be made public as it progresses.

### INTRODUCTION

On March 7, 1995, the U.S. Department of Transportation (DOT) and General Motors Corporation (GM) entered into an administrative agreement, which settled an investigation that was being conducted by the National Highway Traffic Safety Administration (NHTSA) regarding an alleged defect related to fires in GM C/K pickup trucks [NHTSA 1994 and 2001].

Under the GM/DOT Settlement Agreement, GM agreed to provide support to NHTSA's effort to enhance the current Federal Motor Vehicle Safety Standard (FMVSS) No. 301, regarding fuel system integrity, through a public rulemaking process. GM also agreed to expend \$51.355 million over a five-year period to support projects and activities that would further vehicle and highway safety. Ten million dollars of the funding was devoted to fire safety research [NHTSA 2001].

Subsequent to the GM/DOT Settlement, GM agreed to fund an additional \$4.1 million in research related to impact induced fires. This latter research project was included under the terms of a judicial settlement. The fuel safety project objectives are defined by the White, Monson and Cashiola vs. General Motors Agreement dated June 27, 1996 [Judicial District Court 1996]. All research under the project will be made public for use by the safety community. The purpose of this paper is to provide an initial public

report on the projects that have been funded under this research program, along with results to date.

Research projects that have been initiated include the following:

1. A statistical analysis of field data to determine the frequency of fuel leaks and fires by model year and by other crash attributes.
2. A case by case study of fuel leaks and fires in NASS/CDS and an assessment of opportunities for reduction of vulnerability.
3. The assessment of the state-of-the-art technology to reduce the frequency of fires in motor vehicles and/or to delay the time for fires to propagate to the fuel or the interior of the occupant compartment.
4. The evaluation of fuel tanks of various shapes when subjected to fire and impact testing required by ECE or other government standards.
5. The development of recommended practices for the prevention of fires in vehicles equipped with 42-volt electrical systems.

The status and results of each of the above projects is summarized in the sections to follow.

## **STATISTICAL ANALYSIS OF VEHICLE FIRES**

The occurrence of serious injuries and fatalities from fires has remained virtually unchanged over the past ten years. Based on data published by the NHTSA for the year 2000, there were a total of 1,657 (2.9%) fatal and approximately 5,000 (0.1%) injury crashes in which there was a fire [NHTSA 2002]. Of these, 328 crashes, totaling 552 fatalities, coded fire/explosion as the most harmful event. Between 1991 and 2000, the percentage of fire related fatal crashes has continued to range between 2.6 - 2.9% of all fatal crashes, and 0.1 – 0.2% of all injury crashes. Although driving exposure has increased over this time period, the occurrence of these fatalities and serious injuries warrants a more detailed investigation into the nature of these crashes.

Previous work has focused on the seriousness or severity of fire related casualties, including injury and fatality frequencies during impact induced car fires. Additionally, impact induced fuel leakage has also been studied, which may be another indicator of the performance and crashworthiness of fuel systems. Due to the continued occurrence of these events, there appears to be a necessity to reevaluate this topic as it applies to the current U.S. vehicle fleet. This includes looking at the effects of model year, crash

severity, fuel leak hazard, impact modes, and vehicle types. Previous studies have not focused on the vehicle mix, which has changed dramatically over the past decade. Of particular interest is the increasing population of light trucks (pick-ups, vans, and SUVs).

Several resources were used to determine the factors related to the actual occurrence and impact of fires in light passenger vehicles. These factors included (1) an investigation into the availability of fire related data from state, federal, private, and international sources, (2) a statistical analysis of national data from 1975-present, (3) a statistical analysis of selected state accident records from 1978-present. Results from item (2) will be presented here. Work under item (1) and (3) is still underway and results will be published at a later date, along with updates in the other areas.

### **Analysis of State and National Data from 1975-Present**

Previously, Malliaris examined FARS 1975-1987 to understand certain trends in accidents associated with fire events [Malliaris, 1991]. The analysis reported in this paper further extends the Malliaris work to include the present vehicle fleet and provide a differentiation by vehicle type.

Malliaris also examined Michigan state data for the years 1978-1984 to assess fire rates and fuel leakage rates in police reported crashes [Malliaris 1991]. At present the state data study is being updated and applied to states other than Michigan. In 1990, Michigan discontinued reporting fuel leakage. Consequently, this condition could not be updated. Initial studies have confirmed a number of findings initially reported by Malliaris. The extension of the analysis to later years is now underway and will be reported when completed.

### **Fire Rates in Vehicles 0-4 Years Old Involved in Fatal Accidents**

Figure 1 shows the fire occurrence for vehicles 0 to 4 years old at the time they were involved in fatal accidents. To be counted, a fire had to occur in the vehicle after the crash and a fatality had to occur in the crash. The fatality may or may not have been in that particular vehicle or caused by the fire. Figure 2 displays the same data adjusted for vehicle exposure. The exposure metric used in the figure is the number of registered vehicle years by vehicle class, given as million vehicle years or MVY.



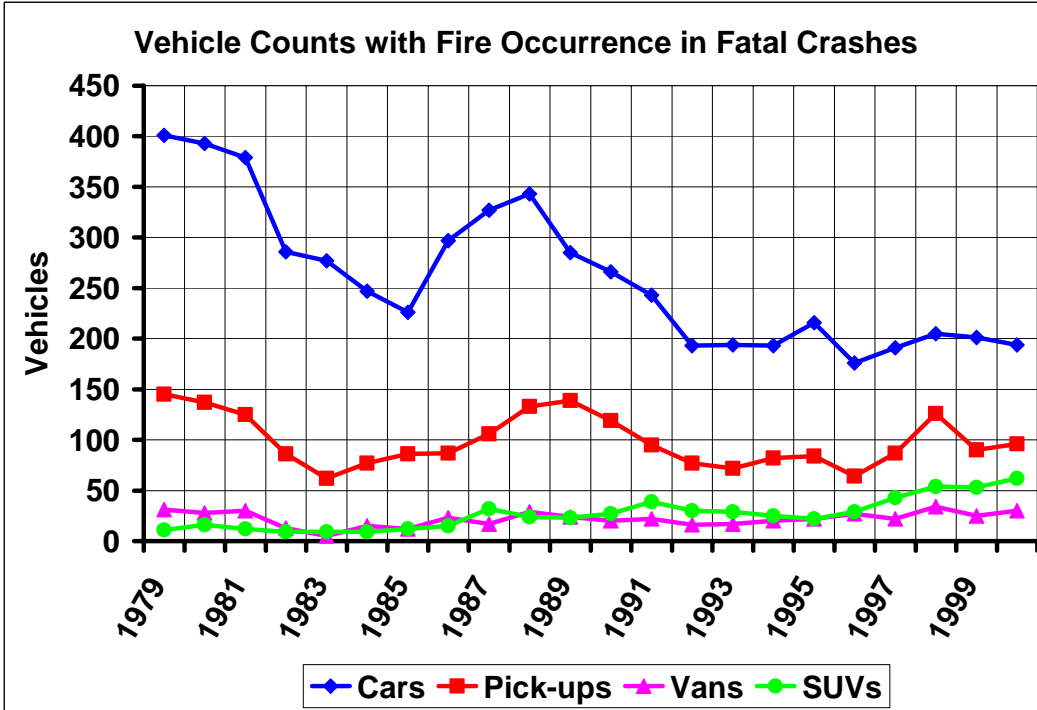

Figure 1. Frequency counts of vehicles involved in fatal crashes where a fire occurred in that particular vehicle (fatality did not necessarily occur in the vehicle with the fire). Data is from FARS 1979-2000, vehicle age is 0-4 years, and distributions are by vehicle type.

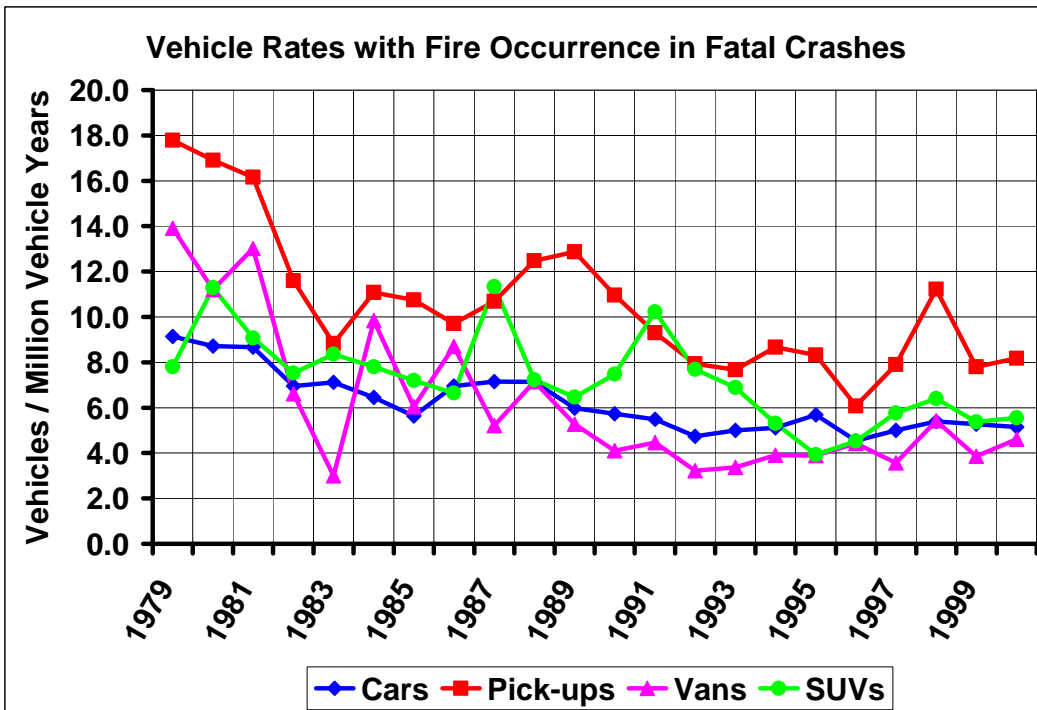

Figure 2. Rates per million vehicle registered years of vehicles involved in fatal crashes where a fire occurred in that particular vehicle (fatality did not necessarily occur in the vehicle with the fire). Data is from FARS 1979-2000, vehicle age is 0-4 years, and distributions are by vehicle type.

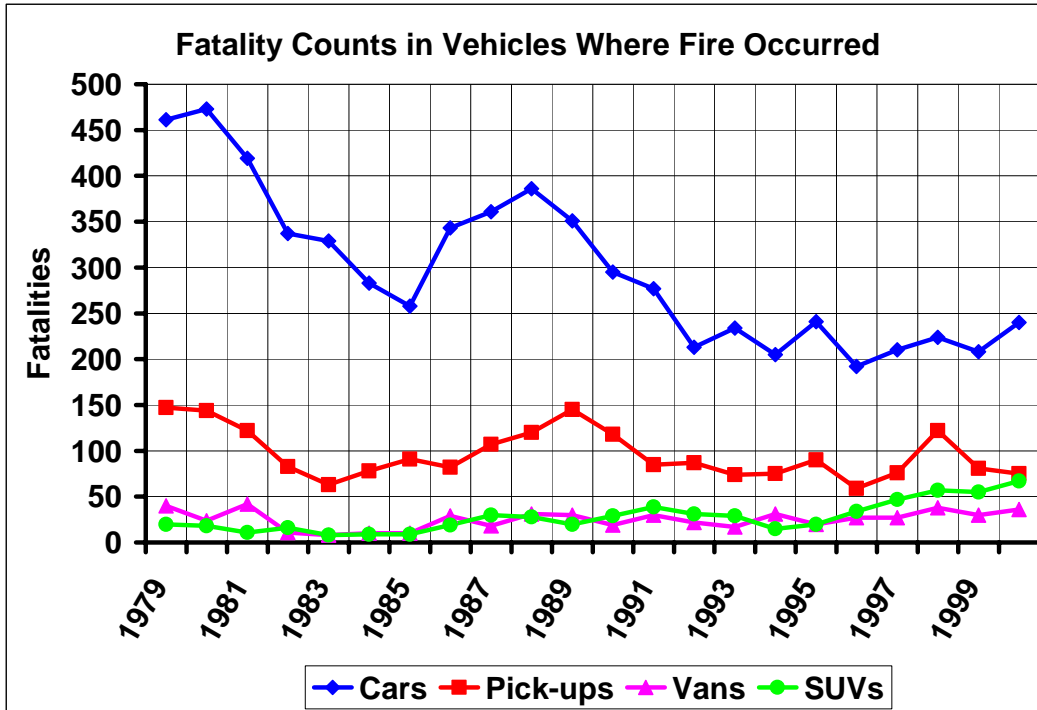

Figure 3. Fatality counts in vehicles where there was the occurrence of a fire/explosion (fatality is not necessarily attributed to the fire event). Data is from FARS 1979-2000, vehicle age is 0-4 years, and distributions are by vehicle type.

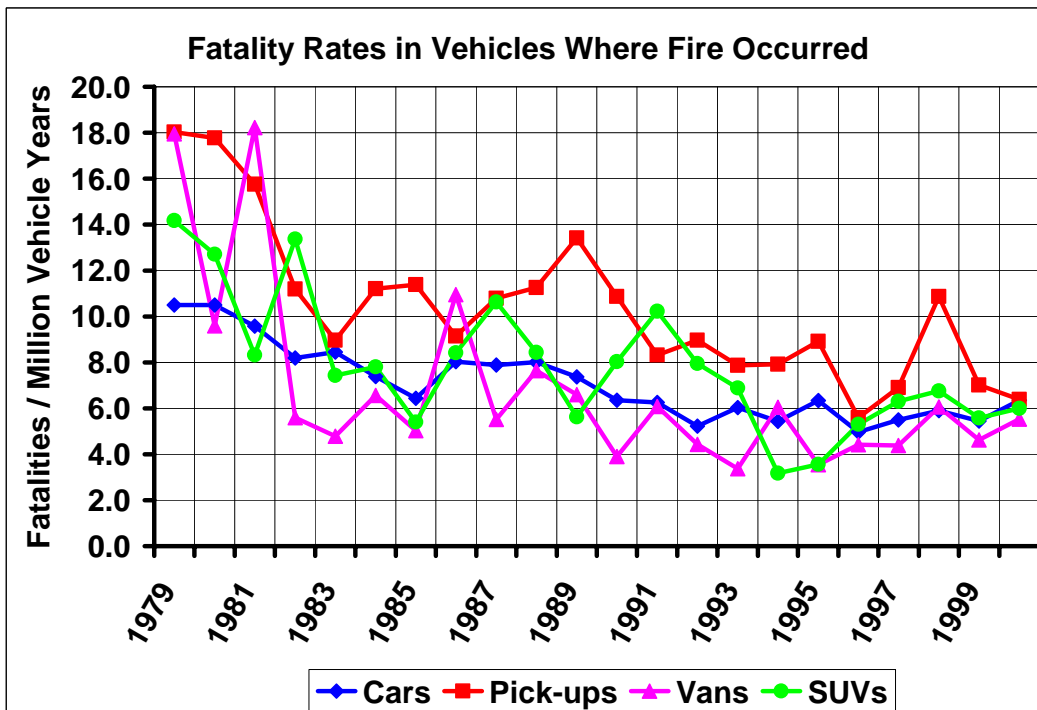

Figure 4. Fatality rates per million vehicle registered years in vehicles where there was the occurrence of a fire/explosion (fatality is not necessarily attributed to the fire event). Data is from FARS 1979-2000, vehicle age is 0-4 years, and distributions are by vehicle type.

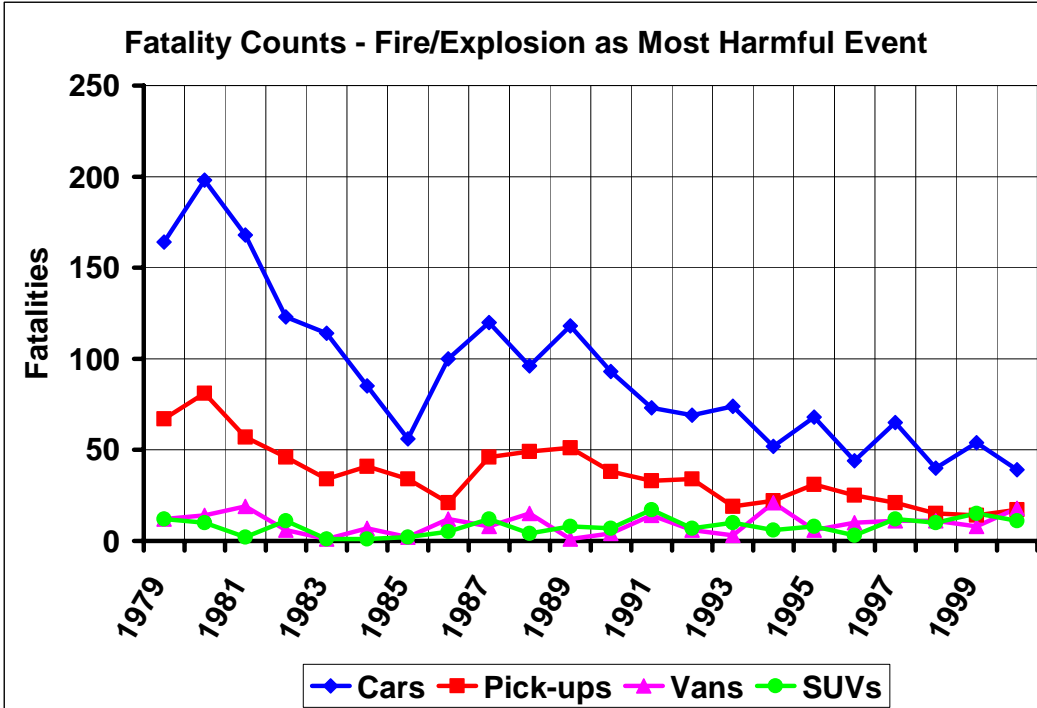

Figure 5. Fatality counts in vehicles where there was the occurrence of a fire/explosion and the fire event has been coded as the most harmful event (i.e. cause of death). Data is from FARS 1979-2000, vehicle age is 0-4 years, and distributions are by vehicle type.

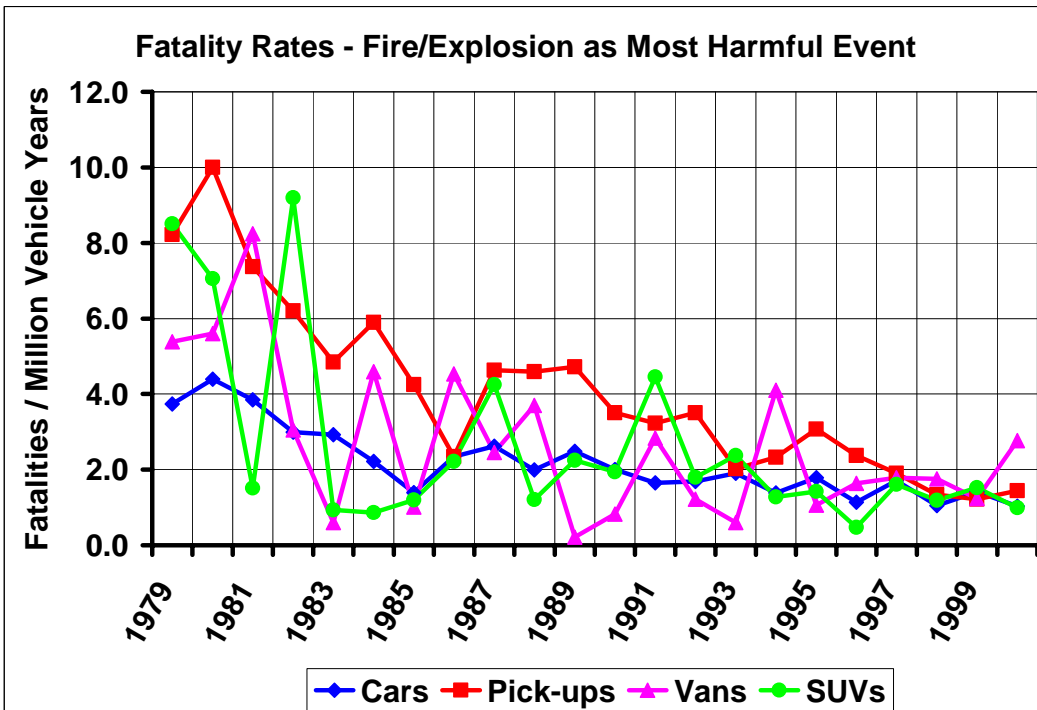

Figure 6. Fatality rates per million vehicle registered years in vehicles where there was the occurrence of a fire/explosion and the fire event has been coded as the most harmful event (i.e. cause of death). Data is from FARS 1979-2000, vehicle age is 0-4 years, and distributions are by vehicle type.

This study looks at vehicles of age 0-4 years; therefore, FARS year 2000 includes models years 1996-2000. A significant occurrence took place during model year 1976 with the introduction of the FMVSS 301 standard for fuel system integrity. Based on data in these figures, FARS year 1981 would be the first year with all vehicles FMVSS 301 compliant.

Figures 3 and 4 provide the fatality counts and rates for fatal crashes in which the fatality occurred in the vehicle where there was a fire. In these figures the fatality was not necessarily attributed to the fire event. Figures 5 and 6 relate the number and rate of fatalities to the fire event. In these figures, the fire event has been coded as the most harmful event, indicating it was the cause of the fatality. Often times it may be difficult to discern the cause of the fatality in these crashes (biomechanical trauma vs. fire trauma). This distinction was not investigated and the coding was taken directly from FARS. Previous studies have attempted to investigate the uncertainty and difficulty in coding fire as the most harmful event [Davies 2002].

It is positive to note that fire occurrence rates and fatality rates, including most harmful event rates, have declined since 1979 for all vehicle classes. With regard to fire occurrence counts and fatality counts, passenger cars and pick-up trucks have shown significant declines since 1979. Vans have remained relatively constant, while SUVs have shown a slight increase in recent years. The rise in SUVs is offset by the increased number of vehicle registrations over the same time period. SUV registrations have increased by 790% since 1979, and by over 300% since the early 1990's. Even with the increased exposure, rates have declined.

Passenger cars have shown the greatest decline in fire occurrence counts (207 fires - 51.6%), while pick-up trucks have the largest rate decline (9.62 fires/MVY). Pick-ups still maintain the highest rate for vehicle fires at 8.17 fires/MVY. In 2000, the fire rate for passenger cars was 5.14 fires/MVY, compared to 6.39 fires/MVY for light trucks. When looking at the overall decline in fire rates, cars have dropped by 43.7% and LTVs (pick-ups, vans, SUVs) by 59.7%. More importantly fatality rates by most harmful event have declined by 72.3% for cars and 79.7% for LTVs. Tables 1 and 2 display data from 1979 and 2000 for fire occurrence rates and fatality (most harmful event) rates respectively.

**Table 1. Fire occurrence rates, vehicles age 0-4 in FARS**

|         | Cars  | Pick-ups | Vans  | SUVs  | All LTVs | All Vehicles |
|---------|-------|----------|-------|-------|----------|--------------|
| 1979    | 9.13  | 17.79    | 13.91 | 7.79  | 15.86    | 10.56        |
| 2000    | 5.14  | 8.17     | 4.61  | 5.56  | 6.39     | 5.69         |
| Change  | 4.00  | 9.62     | 9.30  | 2.23  | 9.47     | 4.87         |
| Percent | 43.7% | 54.1%    | 66.9% | 28.7% | 59.7%    | 46.1%        |

**Table 2. Fatality rates by most harmful event, vehicles age 0-4**

|         | Cars  | Pick-ups | Vans  | SUVs  | All LTVs | All Vehicles |
|---------|-------|----------|-------|-------|----------|--------------|
| 1979    | 3.74  | 8.22     | 5.39  | 8.50  | 7.72     | 4.58         |
| 2000    | 1.03  | 1.45     | 2.77  | 0.99  | 1.56     | 1.27         |
| Change  | 2.70  | 6.77     | 2.62  | 7.52  | 6.15     | 3.31         |
| Percent | 72.3% | 82.4%    | 48.6% | 88.4% | 79.7%    | 72.4%        |

This FARS data is also being reviewed for such variables as crash mode (frontal, rear, rollover, etc.), impacting object, and more. Certain vehicle characteristics may reveal trends; however the relatively low number of fire events may prevent significant findings as the data is further categorized.

### CASE REVIEWS OF VEHICLE FIRES

For the first phase of this study, the National Automotive Sampling System – Crashworthiness Data System (NASS/CDS) was used as the source of data in the analysis of detailed case studies. There have been two primary tasks completed to this stage. These include 1) the development of a NASS analysis tool for fire and fuel leakage cases, and 2) the application of this tool toward the study of NASS/CDS cases.

A crash query and case summary reporting tool is currently under development to help researchers review historical crash cases collected through NASS/CDS. The web based query page allows a user to select a specific subset of crashes from the database, based on desired crash conditions. It has been further enhanced to identify cases based on fire/fuel leakage variables.

The NASS/CDS tool performs a query based on a series of limiting conditions, and then returns two sets of information. First, data relating to the generated subset of crashes is available in tabular form. Since a large set of crash variables may be returned, a user is able to perform sorting and scanning on the data to look for trends and relationships between variables not evident during the initial query.

The second piece of information returned is a list of all cases that meet the query criteria. A user can select a case for further investigation. Following case selection, an automated summary sheet(s) is

generated with significant crash variables presented along with applicable pictures and scene diagram.

This query tool was used to identify and summarize 228 cases from 1997-2000 NASS/CDS in which there was a fire occurrence. These cases have been further analyzed to identify certain attributes of the crashes, which include:

- Investigate crash mode distribution in these cases (frontal, side, rear, rollover, etc.).
- Identify the ignition sources of the fires, along with fire location within the vehicle.
- Investigate accidents of similar severity and impact mode in which there was no fire, looking at injury distribution comparisons.

Although this study is ongoing, some initial results are available. It should be noted that NASS/CDS weighting factors were not used in this study due to the complexity and relative randomness of fire events. It was felt that the weighting factors could not be definitively applied to the fire events.

When looking at impact direction, the cases were divided into categories of impact that would be associated with the fire event. For example, if a frontal impact occurred with another vehicle followed by a side impact to a tree, and the tree impact was the source of a ruptured fuel tank, this would be classified as a side impact for this study. Based on this criterion, frontal impacts accounted for 117 cases (51.3%), side impacts 42 cases (18.4%), rear impacts 14 cases (6.1%), and rollovers 55 cases (24.1%). These results can be seen in Figure 7. It is interesting to note that rear impacts had the lowest frequency of fire events.

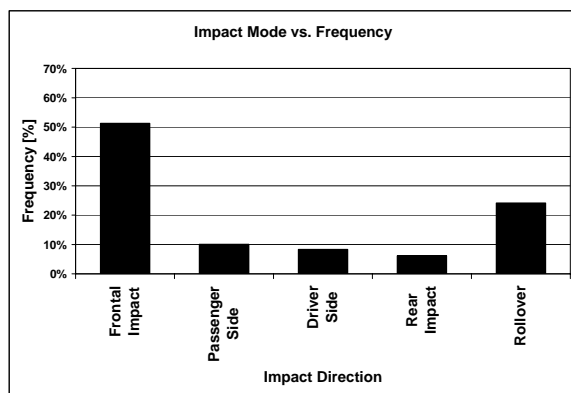
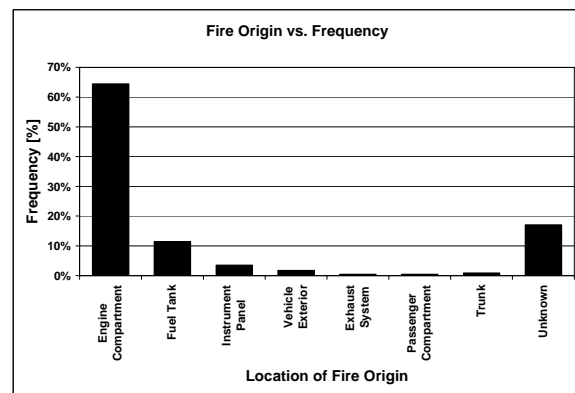

**Figure 7. Distribution of fire events by impact direction.**

Each impact mode is being further investigated to identify any possible trends. This includes impact mode in combination with impacting object and origin of the fire. Rollover events are being reviewed

to understand the various contributions of the role events. This includes roll severity (number of ¼ turns), roll direction, and fire origin relative to roll events.

The location and/or origin of the fire can provide useful information to researchers looking to further improve vehicle design and prevent fire events. The distribution of the fire origin within these NASS/CDS cases is shown in Figure 8. Of particular interest is that a large majority of fires (147 cases – 64.5%) initiated inside the engine compartment. In 26 cases (11.4%) it could be definitively determined that the fuel tank was the source of the fire. Often times it is difficult or impossible to determine the fire origin. This typically occurs in cases in which the vehicle was completely engulfed. There were 39 cases (17.1%) with unknown fire origins. This distribution is similar to previous studies and warrants further investigation into specific sources of fire initiation within the engine compartment.



**Figure 8. Distribution of fire origin/location.**

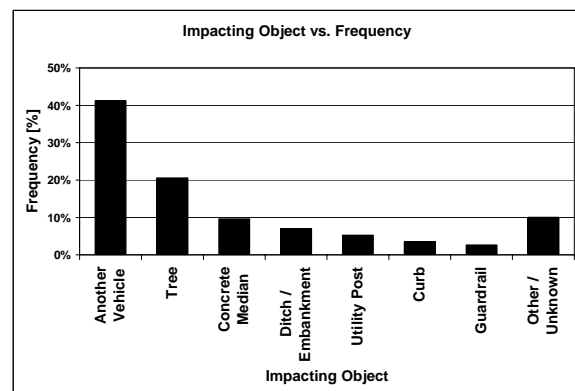
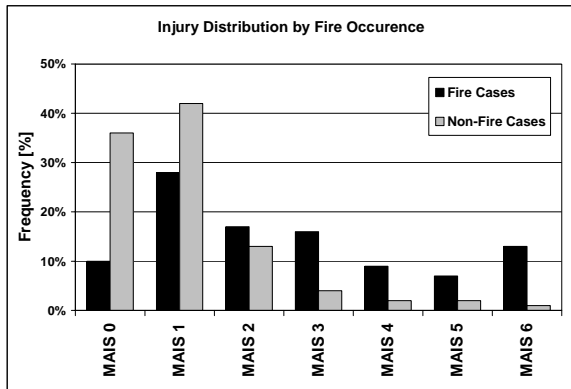

**Figure 9. Distribution of fire events by impacting object.**

This initial review of the data also identified the distribution of impacting objects for fire events (Figure 9). In 94 cases (41.2%) another vehicle was

the impacting object that was associated with the fire event. Although Figure 9 shows a more detailed breakdown of the impacting object, it can be seen that in 111 cases (48.7%) a fixed roadside object was the source of impact and the fire event. In a majority of these cases the fixed object is narrow and results in significant penetration at concentrated locations along the vehicle. Though further investigation is warranted and ongoing, impacts with fixed narrow objects account for a larger portion of the fuel tank related fires.

Of particular importance in any vehicle safety investigation is to study the relationships with occupant injury and fatality. While it is interesting to look at injury distributions within a particular type of event, it is also necessary to gauge the relative importance of the findings. For this study, it can be done by comparing all crash events with fire events. Injury distributions based on MAIS is shown in Figure 10. The data is displayed for all fire event cases along side all non-fire cases. It should be noted that the MAIS for the fire cases is associated with the fire event. For example, if the crash victim had an AIS 5 associated with steering wheel contact, and an AIS 2 associated with the fire event, the case is classified as MAIS 2 for this study. This attempts to normalize to a certain extent for the fire event, but it should be noted that it is often difficult to discern these injuries at higher severities.



**Figure 10. Injury distribution by MAIS for fire and non-fire cases.**

Results show some interesting initial findings. Fire events tend to have a significantly greater percentage of MAIS 3+ associated injuries. While fire events are relatively infrequent, their occurrence tends to have greater associated harm. Further investigation into the injuries within each case is ongoing.

## SURVEY OF STATE-OF-THE-ART IN FIRE SAFETY TECHNOLOGY

An investigation of the state-of-the-art in fuel systems has been undertaken with a focus on identifying fuel system fire safety technologies for preventing and/or mitigating post-crash fuel fires that may be in use today. An extensive survey will be conducted with in-vehicle evaluation and documentation of the various systems. Additionally, major fuel system components, such as the fuel tank itself, will be evaluated. The project is divided into two phases:

- Phase 1 defines the overall scope of the investigation and establishes procedures for carrying out the more specific review of individual systems. Included is a review of existing automotive fuel system standards.
- Phase 2 comprises the in-depth evaluation of the fuel systems from vehicles identified in Phase 1. The work performed under Phase 1 of the project is discussed herein.

Forty two different fuel system performance standards from world wide standards agencies and governing bodies were reviewed as part of the investigation into the state-of-the-art in fuel systems. These standards have been summarized and reported previously [Fournier 2001].

Various design strategies or technologies associated with the fuel system, which includes the evaporative emissions hardware, have been identified as potential countermeasures for preventing or mitigating the likelihood of post-crash vehicle fires. These strategies or technologies, which may already be employed in existing vehicles, include:

- **Filler check valve:** If the filler hose is torn from the tank a check valve located at the spout on the tank would prevent excessive fuel loss.
- **Shielding:** Shields may be used to increase the fuel system's resistance to damage resulting from direct contact and debris by providing an additional layer of protection.
- **Tank materials, thickness:** The choice of tank materials (plastic vs. metal) and its thickness will affect the resistance to punctures, tearing or bursting.
- **Multiple layered tanks:** Although principally used to address emission issues, multiple layered constructions may improve robustness.
- **Tank bladders:** Compliant and tear resistant bladders contained inside a tank prevent fuel



leaks if the rigid outer shell of the tank system is compromised.

- Tear away fuel line connections with check valves: These connections are designed to disengage and seal if excessive tension is applied to the fuel lines.
- Fire shields/blankets: Fire retardant shields, affixed to the hood fall into place to smother engine compartment fires.
- Anti-siphoning: The routing of fuel lines are such that if severed they would not continue to siphon fuel from the tank.
- EFI Fuel Pump shut off: The fuel pump would be deactivated if a crash is detected.
- Active fire suppression systems: Fire detectors would trigger the release of fire suppressant chemicals.
- Tank additives: Reticulate materials placed inside the tank to prevent explosions of the tank.
- Location, tank environment and routing of fill and delivery lines: Placement of fuel system components relative to potentially intrusive or aggressive components to minimize damage in the event of a collision.
- Slip-in-tube drive shaft: In a frontal collision of a rear wheel drive vehicle, the drive shaft would collapse along its length to minimize damage to a rear mounted tank.

The North American fleet comprises over three hundred makes and models of vehicles, not including variations within a model. The inspection of each one is beyond the current scope of the review which intends to gain a cross-section view of the best practices in fuel system fire safety design. A subset of these vehicles has been proposed and consists of a cross section of vehicle type (car, SUV, truck, etc.), manufacturer, price range, country of origin, etc. Also, vehicles with known technology implementations will be reviewed.

Information on each vehicle is collected and input into a Microsoft Access<sup>®</sup> database. This includes, but is not limited to:

- Tank shape and placement
- Presence of technologies listed previously
- Routing of fuel lines and components associated with the fuel delivery system
- Type and location of batteries and power sources
- Proximity of potentially “aggressive” structural components

In addition to visual inspections, vehicle brochures and user manuals will be reviewed, along with repair and maintenance manuals. Accompanying digital photos are also placed in the database.

A sample vehicle inspection has been completed as part of phase 1 of this study. Phase 2 – the inspection of 70 vehicles – is underway and all data will enter the public domain upon completion.

## EVALUATION OF PLASTIC FUEL TANKS OF VARIOUS SHAPES

The purpose of this program is to conduct comparison evaluations of existing plastic fuel tanks to performance standards applied in Europe and also to standards applied to tanks for trucks in the US. The tests also examined degradation in service. Two ages of tanks were tested; 1) “conditioned” tanks, not older than four years, and 2) “new” tanks, from original equipment manufacturers (OEMs). The conditioned tanks were from vehicles that have been operated in a warm climate in the vicinity of San Antonio, Texas. The new tanks were purchased from the OEM supply and not from an after market supplier. The project evaluated three different tank design shapes.

The three tank design shapes are as follows: 1) a “pancake” tank typical of tanks in front wheel drive cars with a thin shape mounted to an underbody near the rear seat area and in front of the rear axle; 2) a “long” tank with a narrow shape mounted inside the frame rail and in front of the rear axle; and 3) a “square” tank mounted behind the rear axle. The three types of tanks are shown in Figures 11-13.

Three types of tests were conducted for new and conditioned tanks for each of the three tank shapes. The tests were: fire resistance, concentrated energy cold impact, and high energy impact.

The fire resistance tests were conducted in accordance with the European Standard for plastic fuel tanks, ECE R 34, Annex 5, Fire Resistance Section. This standard requires the plastic tank to withstand a pool fire for two minutes without leaking. In this test, the tank is mounted on the actual vehicle and filled with gasoline to 50% of capacity. For one minute, the vehicle and tank were subjected to the full intensity of a fuel-fed pool fire positioned directly beneath the tank. For the second minute, the intensity of the fire was mitigated by covering the fire pan with a screen. If the tank survives for two minutes it is said to “pass.”

In the research testing conducted under this project, a third condition was imposed. In this third condition, the screen was removed and the high intensity fire was continued until tank leakage occurred. Once



Figure 11. "Pancake" shaped tank pre-test.



Figure 14. "Pancake" tank after fire test.



Figure 12. "Long" shaped tank pre-test.



Figure 15. "Long" tank after fire test.



Figure 13. "Square" shaped tank pre-test.



Figure 16. "Square" tank after fire test.

leakage was observed, the fire was extinguished quickly by fire suppressants. The results reported in Table 3 shows the number of seconds after removal of the screen at 2 minutes until the tank leakage occurred

In these fire tests, all of the conditioned tanks were the original tanks installed on the 1998 model year

vehicles that were subjected to the burn tests. These conditioned tanks were tested before the "new" tanks were installed on the same vehicle. In all cases, the fire exposure caused some loss of body material from the vehicle. Consequently, added area for ventilation might exist in the second test. To reduce the effects of differences in ventilation, the vehicle with the "pancake" tank was rebuilt for the second test. The

other vehicles suffered less degradation and were not rebuilt. The second test of the “square” tank resulted in tank leakage at 101 seconds – 19 seconds short of the requirement. This difference could be explained by the increased ventilation permitted by the test buck.

**Table 3. Number of Seconds After Removal of Fire Screen Until Tank Leakage Occurred**

| Tank Type | New | Conditioned |
|-----------|-----|-------------|
| Pancake   | 90  | 90          |
| Long      | 38  | 21          |
| Square    | -19 | 10          |

Other observations made from the tests included the location and size of the initial leak that occurred before the fire was extinguished. The two pancake tanks leaked at the same place – the bottom left rear corner. In both cases, the leaks were very small. The two square tanks both leaked in locations that were associated with loading by the mounting strap. Both tanks also leaked or were severely weakened at the front right top corner due to sagging of the tank. The rate of leakage from the square tank was greater than for the pancake tank. The two long tanks both leaked due to sagging of the front part of the tank that overhung the mounting straps. The leakage occurred at the front of the tank or at the straps. The rate of leakage was greater than the square tank. The post test deformation of the “pancake” tank, the “long” tank, and the “square” tank are shown in Figures 14 through 16.

Impact resistance was conducted on three new and three seasoned tanks. The impact tests were of two types. First tests were conducted in accordance with the European Standard for plastic fuel tanks, ECE R 34, Annex 5, Section 1 “Impact Resistance”. Second, tests were conducted in accordance with 49 CFR 393.67, “Liquid Fuel Tanks”.

For the ECE R 34 impact resistance test, the tanks are filled to rated capacity and chilled to -40 degrees C. At this temperature, they are impacted by a pyramid shaped 15 kg mass at an energy level of 30.1 Nm. In the research tests, tanks were impacted at the right front corner at energy levels ranging from 30.1 Nm to 43.6 Nm. No leakage occurred in any of the tests.

Federal Motor Carrier Safety Regulation CFR 393.67 “Liquid Fuel Tanks” requires an impact test condition that has not been applied to passenger vehicles. Section (e) (1) of the standard applies to side-mounted tanks and requires a drop test of the tank. In this test, the tank is filled with water to a weight

equal to the rated weight of fuel and dropped on its corner from a height of 30 ft. onto an unyielding surface. The standard limits the allowable leakage after the test to 1 oz per minute.

**Table 4. Leakage rate in oz. per minute for Three Types of Tanks After 30 ft Drop Test per CFR 393.67 (e) (1)**

| Tank Type | New | Conditioned |
|-----------|-----|-------------|
| Pancake   | <1  | <1          |
| Long      | <1  | 150         |
| Square    | <1  | 900         |

The results of the 30 ft drop tests are shown in Table 4. All of the new tanks and the seasoned pancake tank passed the test. However, both of the other seasoned tanks ruptured at the pinch-off separation. A typical breach of the tank is shown in Figure 17.



**Figure 17. Seasoned “Long” Tank Post Drop Test**

This limited research indicates that the tested tanks performed in a repeatable manner when subjected to ECE R 34, Annex 5, “Fire Resistance” Section. However, considerable difference in the margin for passing the test was present for the three tank types. In addition, the amount of leakage that occurred once the leak was initiated was vastly different. The behind the axle location of the “square” tank permitted the greatest amount of ventilation, and consequently may have been the most severe environment. The overhang of the long tank beyond the supporting straps appeared to be the most vulnerable feature of that tank shape. There was no identifiable difference between the performance of new and seasoned tanks in these tests.

All three tanks performed satisfactorily when subjected to the ECE R 34 Impact Resistance test, even when subjected to an impact with approximately

50% more energy than required by the test. No degradation was noted in the seasoned tanks.

All three new tanks performed satisfactorily when subjected to the Federal Motor Carrier Safety Regulation CFR 393.67 (e)(1) 30 ft. drop test. However, the seasoned “long” and “square” tanks leaked excessively after the drop. This result suggests some degradation of the resistance to severe impact with aging for these tanks.

## **DEVELOPMENT OF RECOMMENDED PRACTICE IN 42-VOLT APPLICATIONS**

Major auto manufacturers are currently developing electrical systems that operate on 36-volt architectures, transitioning from the current 12-volt systems (14 volts when charging) typically used today. The 36 volt architecture charges at 42 volts, with possible voltage peaks as high as 58 volts. Current best practice and recommendations from ISO restrict the ability for human interface with voltages above 60 volts, thus the selection of the 36-volt architecture. Because the normal operating range is 42-volts, they are typically referred to as 42-volt systems.

There are several reasons why this transition is taking place. Power demands have been growing at about 6% per year for the last 15-20 years [SAE 2002, TOPTec 2002, Intertech 2002]. Modern cars consume between one and three kilowatts of power. They are near the limit of what can be done with the 12-volt architecture. This growth in power demand results from the expanding use of electronics in autos: radio and hi-fi systems, navigation systems, use of electrical outlets for plug-in computers, etc. In the future, there are many conventional systems that can be driven electronically. Electrically assisted power steering is now on the market. Electric brakes, electric rear wheel steering, electric suspension and stability control, electric drive for water and oil pumps, advanced automatic crash notification (ACN) systems, electric air conditioning and heating systems, and 110 volt AC outlets are all new applications which may be attractive after 42 volts becomes available. Some of these new components have fuel economy, emissions, and/or safety benefits.

Another major trend is toward “mild hybrids,” where the engine is shut off when stopped in traffic, and other systems, such as the air conditioning continue to operate. This technology is commonly referred to as an integrated starter generator and can provide approximately a 10% fuel economy improvement in city driving.

Even at 14-volts, there are fires caused by shorts and other malfunctions in the electrical systems. As was shown previously in the data analysis, more fires occur in frontal impacts, and initiate within the engine compartment. Since batteries are typically mounted in that region of the vehicle, and most of the under-hood fluids are flammable (including the engine coolant), there is reason to suspect that the battery may contribute to many under-hood fires. Batteries contain a great deal of energy (~ 3 million Joules for an 85 Ampere-hour battery). A short can dissipate hundreds of Watts, and can ignite surrounding flammable materials. A crushed battery can create either external or internal shorts and begin a heat release that can ignite the plastic battery case, and then spread to other under-hood materials.

If a circuit is broken with a 14-volt circuit, some sparking may occur, but not a sustained arc. With a 42-volt system there is likely to be a sustained arc when a circuit opens or there is a short to ground. This arc has tremendous power associated with it. It can easily produce 1000 Watts of power and release 1000 Joules per second. The temperature of the plasma can be 6000 C. This level of power can ignite most materials and can burn holes in sheet steel.

There is also another phenomenon called “Carbon Tracking” which can be present at 14 volts, but will be more common at 42 volts. It is caused by an electric field across an “insulator.” “Insulators” can conduct small amounts of electricity and gradually convert the hydrocarbons in the plastic to carbon - which is a good conductor. After considerable time (i.e. 10-15 years of a vehicle lifetime), this deposit of carbon can grow until it is capable of conducting a large amount of current. Shortly after the current builds up, the material will effectively short and cause an arc, and the material can flash into flame.

This process is accelerated by having conducting liquids or solids on the surface of the conductor. Oil, dirt, grime and moisture, which are readily available in the engine compartment, can get on the plastic electrical components and speed-up the process. Road salt (and battery acid released in a crash) are also conductors which can exacerbate the situation. 42-volt systems (with associated voltage margins) will be more susceptible to this phenomenon.

MVFRI is working with the USCAR 42-volt Working Group to fund a 42-volt research project at Underwriter’s Laboratories (UL). The purpose of this effort is to investigate Carbon Tracking phenomena with 25 different plastic samples that are



representative of materials used in connectors, terminal strips, and wire insulation. A 5% salt solution, typical of spray from salted roads in winter conditions, will be used to stress the material. One calibrated drop will fall every 30-seconds. After 50 drops (~25 minutes) the material is said to "pass." Some materials will be tested for 500 drops to validate that 50 drops is an acceptable stopping point.

The second effort under consideration will be to test a selection of materials to determine their flammability after being exposed to arcs likely to be created by 42-volt systems. These arcs are very high intensity and most materials will ignite if exposed long enough. The distinguishing factor is how much energy they can absorb before igniting. The number of materials is potentially much larger in number than for the carbon tracking testing. Any material that could be exposed to arcing needs to be tested - including some of the flammable under-hood fluids.

Results from these studies will be published at a later date and it is expected that these works may form the basis for recommended best practice and/or test standards associated with 42-volt systems.

## CONCLUSIONS

For the year 2001, there were a total of 1,657 fatal crashes in which there was a fire. This is about 2.9% of all fatal crashes. Analysis of FARS data indicates that the fire rates in cars has dropped by 43.7% and LTVs (pick-ups, vans and SUVs) by 59.7% since the 1979. In 2000, the fire rate for passenger cars was 5.14 fires/million vehicle years, compared to 6.39 for light trucks.

For the years 1997-2000 the NASS/CDS contains 228 cases with fires. In these cases, frontal crashes accounted for 51.3% followed by rollover (24.1%) and side (18.4). Rear impacts accounted for the smallest fraction - 6.1%. The most frequent origin for the fire was the engine compartment, accounting for 64.5%. The fuel tank accounted for 11.4%. There were a relatively large number of unknown sources - 17.1%. The most frequent object impacted before the fire occurred was another vehicle (41.2%). However, a variety of roadside objects made up 48.7%. Narrow objects such as poles and trees contributed more than 25%.

Plastic tanks of three different shapes were evaluated to fire and impact testing as required by ECE R34, Annex 5 and US CFR 393.67 (e)(1). The ECE R34 fire test appeared to produce repeatable results and all tanks demonstrated the capability to withstand the

test. All tanks passed the ECE R34 impact test. The US CFR 393.67 (e)(1) requires the tank containing water equal to its rated weight of fuel to be dropped on its corner from a height of 30 ft. All new tanks passed the test. However, two of three tanks that had been in service for three years failed the test. In both cases the failure was pinch off separation, suggesting a possible deterioration of this junction with time.

Research is now underway to identify state-of-the-art technologies in present day motor vehicles. Other research is oriented to developing test methods to assure the fire safety of materials used in vehicles with 42-volt electrical systems. The results of this research will be made public as it progresses.

## ACKNOWLEDGMENTS

The authors would like to recognize that funding for this research was provided by General Motors in accordance with the White, Monson and Cashiola vs. General Motors Settlement Agreement.

The authors would also like to recognize the contributions of several researchers and/or organizations that provided technical input to this paper. This includes: Friedman Research Corporation for the statistical data analysis, Biokinetics and Associates Ltd. for the survey of the state-of-the-art technology, Southwest Research Institute for the evaluation of plastic fuel tanks, and the George Washington University for the NASS/CDS case study reviews. Further details of research and progress associated with this work may be obtained at the following internet address: [www.mvfri.org](http://www.mvfri.org).

## REFERENCES

- Davies, B. T., and Griffin, L. I., "A Clinical Evaluation of the Death Investigations for 206 Decedents Who Died in Passenger Vehicles that Experienced Post-Crash Fires," (January 2002) Docket # NHTSA-98-3588-170, Texas Transportation Institute.
- Fournier, E., and Keown, M. "Survey of the State-Of-The-Art in Fuel System Fire Safety - Phase I," (2001) Prepared for MVFRI by Biokinetics and Associates, Ltd.

"42 Volt Systems" *SAE TOPTEC* (April 2002) Troy, MI.

“42 Volt Technology 2002,” *SAE 2002 World Congress* (March 2002) SAE Publication SP-1661, Detroit, MI.

“Intertech Symposium on 42-volt systems,” (Sept. 2002) Cleveland, OH.

Judicial District Court “Agreement of Settlement, White, Monson and Cashiola vs. General Motors”, Number 42,865, DIV.”D”, 18th Judicial District Court, Parish of Iberville, Louisiana, June 27, 1996.

Malliaris, A.C., “Impact-Induced Car Fires: A Comprehensive Investigation,” (1991) *Journal of Accident Analysis and Prevention*, Vol. 23, No. 4, pp 257-273.

National Highway Traffic Safety Administration, “U.S. DoT/General Motors Settlement Agreement Status Report, Year 4”, NHTSA 2001.

Office of Defects Investigation, “Engineering Analysis Report and Initial Decision That The Subject Vehicles Contain A Safety Related Defect”, National Highway Traffic Safety Administration, Engineering Analysis EA92-041, NHTSA October 17, 1994.

“Traffic Safety Facts 2001,” (2002) National Center for Statistics and Analysis, NHTSA, 400 Seventh Street, S.W., Washington, D.C. 20590.



**Attachment E**  
**Smith v. DaimlerChrysler**



**DaimlerChrysler Settles Suit Of Exploding Jeep Grand Cherokee Yet Makes No Design Changes To Remedy Problem**

July 30th, 2002 (WEST PALM BEACH, Fla.) - Kenneth Smith's life changed in a mere blink of an eye on the morning of October 6, 2001. As his 1995 Jeep Grand Cherokee began traveling through an intersection with a green light his vehicle was rear-ended by a Lincoln Town Car. Immediately upon impact the Jeep burst into flames. Smith, a resident of Jacksonville, Florida, suffered burns to his abdomen, right hand and arm. He has undergone two skin grafts, and must wear special garments to protect his arm and hand.

Ken Smith was unaware, as are probably countless other individuals, that the 1995 Jeep Grand Cherokee (as well as the current models of the Grand Cherokee and Jeep Liberty) was unsafe because the fuel tank and filler neck was designed and installed in a location that is susceptible to rupture or puncture in a rear-end collision. In an accident the Jeep's fuel tank will often times rupture and allow gasoline to escape. This almost always presents a high risk of fire and explosion, which will lead to severe injury or death to the vehicle's occupants.

"This vehicle was a virtual time bomb poised to explode," said attorney, Ted Leopold, of Ricci~Leopold, P.A. , West Palm Beach. "The fuel tank of the 1995 model was located behind the rear axle. This puts the tank in a position that leaves it vulnerable to explosion if impacted by another vehicle. DaimlerChrysler could have located the fuel tank forward of the rear axle, as almost all of its competitors do. This would have provided greater protection to the fuel tank, and the occupants of the vehicle in the event of a rear impact collision. If nothing else the company should have at least provided a shield that would protect the fuel tank from rupture."

Today, Ken Smith is making great progress in his recovery from this horrendous accident. Ironically, one would think that the car that hit the back of Smith's Jeep, was

traveling at a high rate of speed. It was not! The vehicle was traveling 20-25 miles per hour at the time of impact.

DaimlerChrysler, settled with Smith for an undisclosed sum of money. However, this was no victory for consumers. Today, anyone can walk on to a DaimlerChrysler lot and purchase a new Grand Cherokee or Jeep Liberty and be at risk for this same type explosion. The fuel tank remains in a location that is susceptible to rupture, puncture or other damage that could cause a failure and allow fuel to escape. In addition, the fuel tank was designed with material that is susceptible to rupture and the fuel filler neck of the Jeeps are routed in such a way that they are susceptible to being torn away, pulled off, punctured or damaged in the event of an accident.

"Justice for Ken Smith was our first order of business in this case," said Leopold. "However, I am disappointed and horrified to see that DaimlerChrysler continues to manufacture these vehicles in this manner. Sadly, we are bound to see many more children and adults riding in these vehicles who will undoubtedly suffer severe burn injuries and even death from horrific car fires."

Founded in 1982, Ricci~Leopold, P.A., has built a reputation as one of the most successful personal injury law firms in the Southeast. The firm represents individuals who have been wrongfully injured in matters involving automotive crashworthiness, managed care litigation, insurance bad faith and coverage disputes, and personal injury. Ricci~Leopold, P.A. headquartered in West Palm Beach, Florida, has seven attorneys representing clients as well as an experienced and skilled research and investigative staff. For additional information, please visit the firm's website at <http://www.ricci-law.com>

**Attachment F**  
**Susan Kline Accident**



Mrs. Susan Kline with her family.

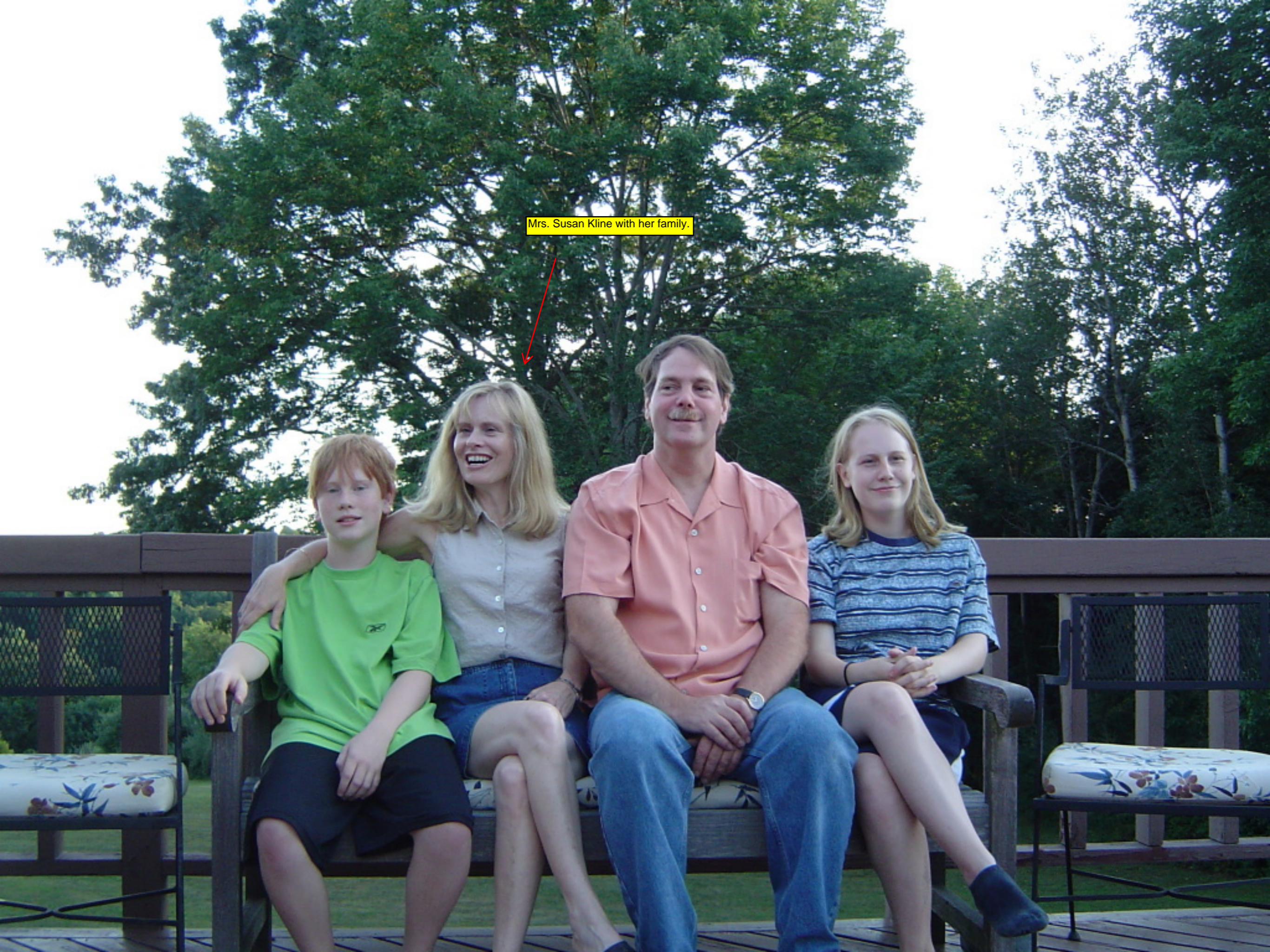







Mrs. Susan Kline (death victim).  
Post fuel-fed fire caused by defective fuel system/tank  
design in Jeep Grand Cherokee SUVs

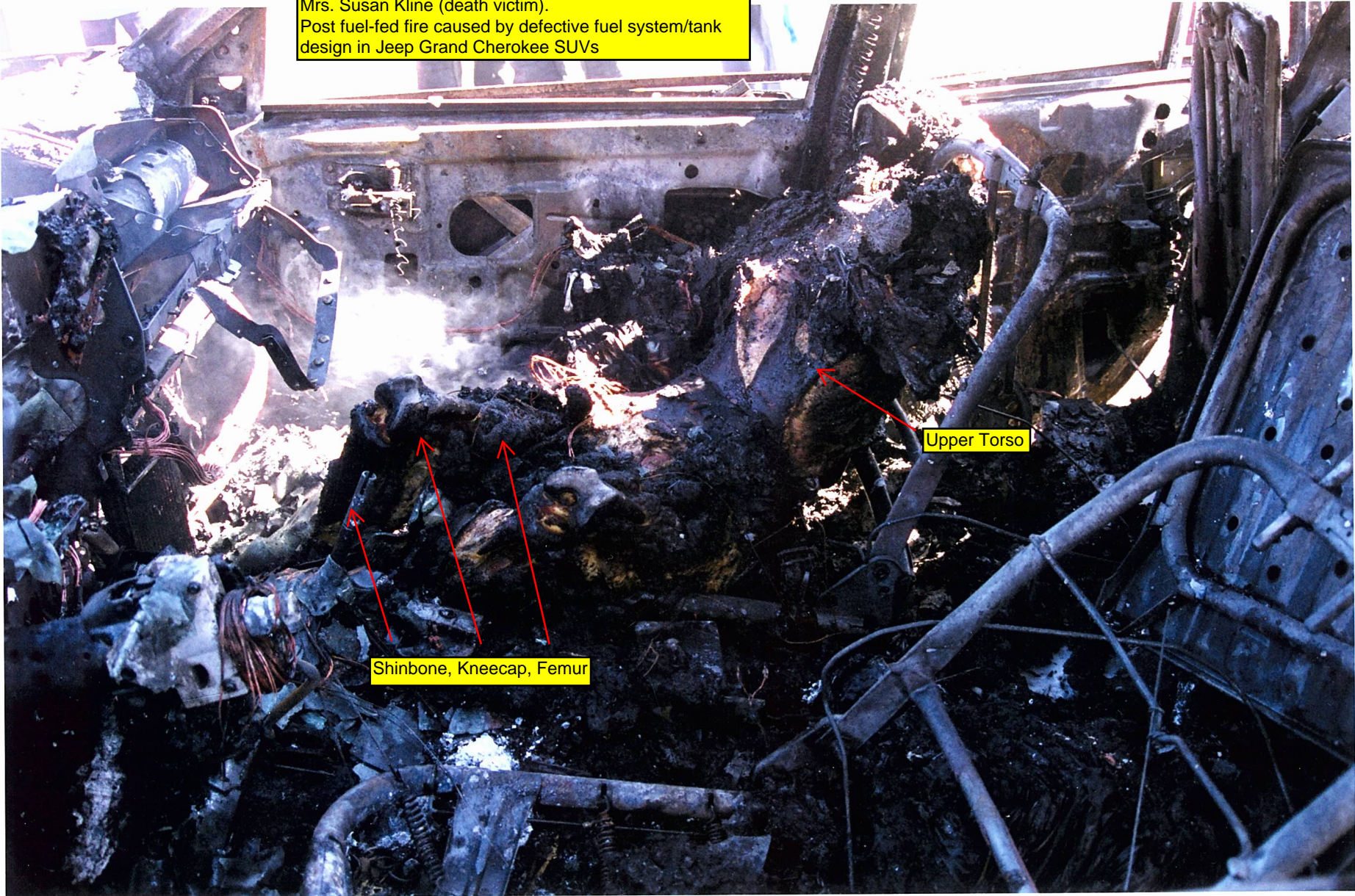

Upper Torso

Shinbone, Kneecap, Femur



**Attachment G**  
**Rodney Wood Accident Report**

FATAL     CMV INVOLVED     SCHOOL BUS RELATED     RAILROAD RELATED     MEDICAL ADVISORY BOARD     HIT AND RUN     AMENDMENT/SUPPLEMENT



# Texas Peace Officer's Crash Report

Form CR-3  
(Rev. 03/09)  
Page 1 of 2

Submission of Crash Records: This report may be submitted via the CRIS Web Portal, electronically submitted via XML, or by mailing to the Texas Department of Transportation, Crash Records, PO Box 149349, Austin, TX 78714.  
Questions? Call: 512/486-5780

PLACE WHERE CRASH OCCURRED  
 COUNTY TARRANT CITY OR TOWN FORT WORTH LOC # 09-076903  
 IF CRASH WAS OUTSIDE CITY LIMITS INDICATE FROM NEAREST TOWN \_\_\_\_\_ MILES     OF \_\_\_\_\_  
 ORI # \_\_\_\_\_  
 TxDOT # \_\_\_\_\_

ROAD ON WHICH CRASH OCCURRED 2350 NE LOOP 820 CONSTRUCTION ZONE  YES  NO SPEED LIMIT 65  
 BLOCK NUMBER STREET OR ROAD NAME ROUTE NUMBER OR STREET CODE WORKERS PRESENT  YES  NO  
 INTERSECTING STREET OR RR X'ING NUMBER \_\_\_\_\_ CONSTRUCTION ZONE  YES  NO SPEED LIMIT \_\_\_\_\_  
 BLOCK NUMBER STREET OR ROAD NAME ROUTE NUMBER OR STREET CODE WORKERS PRESENT  YES  NO  
 NOT AT INTERSECTION 100  FT.     OF 5300 MARK IV PARKWAY MILEPOST \_\_\_\_\_  
 MI. N S E W SHOW MILEPOST OR NEAREST INTERSECTING NUMBERED HIGHWAY IF NONE, SHOW NEAREST INTERSECTING STREET OR REFERENCE POINT LATITUDE \_\_\_\_\_  
 LONGITUDE \_\_\_\_\_

DATE OF CRASH JULY 10 2009 DAY OF WEEK FRIDAY HOUR 5:35  AM  PM # EXACTLY MOON OR MIDNIGHT, SO STATE

UNIT # 1 1-MOTOR VEHICLE 4-PEDESTRIAN 7-NON-CONTACT 8-OTHER VIN # 1VH2B1E20Y6200129 ALTERED VEHICLE HEIGHT  YES  NO  
 2-TRAIN 5-MOTORIZED CONVEYANCE 8-OTHER  
 3-PEDALCYCLIST 6-TOWED  
 YEAR MODEL 00 COLOR & MAKE WHITE - ORION MODEL NAME BUS BODY STYLE \_\_\_\_\_ LICENSE PLATE EXMP TX YEAR STATE 869182 NUMBER

DRIVER'S NAME WARE RONNIE D 4008 HILLDALE FTWORTH, TX 76119 PHONE NUMBER 817-449-9925  
 LAST FIRST M.I. ADDRESS (STREET, CITY, STATE, ZIP)

DRIVER'S LICENSE TX 14869672 B-CDL 12/06/1970 LICENSE STATUS 1 1-VALID 2-NOT VALID 3-SUSPENDED/REVOKED 4-CANCELLED/DENIED 5-EXPIRED 6-UNKNOWN  
 STATE NUMBER CLASS/TYPE ENDORSEMENTS RESTRICTIONS DATE OF BIRTH

DRIVER'S ETHNICITY 3 1-WHITE 4-ASIAN DRIVER'S SEX  MALE  FEMALE DRIVER'S OCCUPATION BUS DRIVER POLICE, FIREFIGHTER, EMS, ON EMERGENCY  IF CHECKED, PLEASE EXPLAIN IN NARRATIVE  
 2-HISPANIC 5-OTHER

TYPE OF ALCOHOL SPECIMEN TAKEN 4 TEST RESULTS \_\_\_\_\_ TYPE OF DRUG SPECIMEN TAKEN 3 TEST RESULTS \_\_\_\_\_ DRUG CATEGORY 1. \_\_\_\_\_ 2. \_\_\_\_\_  
 1-BREATH 2-BLOOD 3-URINE 4-NONE 5-REFUSED 1-BLOOD 2-URINE 3-NONE 4-REFUSED

LESSEE  OWNER FT WORTH TRANSIT AUTH 1600 E LANCASTER FTW TX 76102  
 NAME (ALWAYS SHOW LESSEE IF LEASED, OTHERWISE SHOW OWNER) ADDRESS (STREET, CITY, STATE, ZIP)

LIABILITY INSURANCE  YES  NO  EXP INSURANCE COMPANY \_\_\_\_\_ POLICY NUMBER \_\_\_\_\_ VEHICLE DAMAGE RATING 12-VB-7-FD-3

UNIT # 2 1-MOTOR VEHICLE 4-PEDESTRIAN 7-NON-CONTACT 8-OTHER VIN # 1J4GX48S94C249693 ALTERED VEHICLE HEIGHT  YES  NO  
 2-TRAIN 5-MOTORIZED CONVEYANCE 8-OTHER  
 3-PEDALCYCLIST 6-TOWED  
 YEAR MODEL 04 COLOR & MAKE BLK / JEEP MODEL NAME GRAND CHEROKEE BODY STYLE SUV LICENSE PLATE 09 TX YEAR STATE X34BBC NUMBER

DRIVER'S NAME WOOD RODNEY R 16125 HOLLYHILL CT JUSTIN TX 76247 PHONE NUMBER \_\_\_\_\_  
 LAST FIRST M.I. ADDRESS (STREET, CITY, STATE, ZIP)

DRIVER'S LICENSE TX 19721212 CM 12/12/1972 LICENSE STATUS 1 1-VALID 2-NOT VALID 3-SUSPENDED/REVOKED 4-CANCELLED/DENIED 5-EXPIRED 6-UNKNOWN  
 STATE NUMBER CLASS/TYPE ENDORSEMENTS RESTRICTIONS DATE OF BIRTH

DRIVER'S ETHNICITY W 1-WHITE 4-ASIAN DRIVER'S SEX  MALE  FEMALE DRIVER'S OCCUPATION \_\_\_\_\_ POLICE, FIREFIGHTER, EMS, ON EMERGENCY  IF CHECKED, PLEASE EXPLAIN IN NARRATIVE  
 2-HISPANIC 5-OTHER

TYPE OF ALCOHOL SPECIMEN TAKEN 4 TEST RESULTS \_\_\_\_\_ TYPE OF DRUG SPECIMEN TAKEN 3 TEST RESULTS \_\_\_\_\_ DRUG CATEGORY 1. \_\_\_\_\_ 2. \_\_\_\_\_  
 1-BREATH 2-BLOOD 3-URINE 4-NONE 5-REFUSED 1-BLOOD 2-URINE 3-NONE 4-REFUSED

LESSEE  OWNER SAME AS DRIVER 62491286  
 NAME (ALWAYS SHOW LESSEE IF LEASED, OTHERWISE SHOW OWNER) ADDRESS (STREET, CITY, STATE, ZIP)

LIABILITY INSURANCE  YES  NO  EXP INSURANCE COMPANY PROGRESSIVE INS POLICY NUMBER \_\_\_\_\_ VEHICLE DAMAGE RATING 06-BD7-FD4-VB7

DAMAGE TO PROPERTY OTHER THAN VEHICLES \_\_\_\_\_

OBJECT \_\_\_\_\_ NAME AND ADDRESS OF OWNER \_\_\_\_\_ FEET FROM CURB \_\_\_\_\_ DAMAGE ESTIMATE \$ \_\_\_\_\_

IN YOUR OPINION, DID THIS CRASH RESULT IN AT LEAST \$1,000.00 DAMAGE TO ANY ONE PERSON'S PROPERTY?  YES  NO

CHARGES FILED  
 NAME \_\_\_\_\_ CHARGE \_\_\_\_\_ CITATION # \_\_\_\_\_  
 NAME \_\_\_\_\_ CHARGE \_\_\_\_\_ CITATION # \_\_\_\_\_

TIME NOTIFIED OF CRASH 07/10/09 6:23PM HOW POLICE RADIO TIME ARRIVED AT SCENE 07/10/09 6:53PM DATE OF REPORT 07/11/09  
 DATE HOUR DATE HOUR DATE HOUR  
 TYPED OR PRINTED NAME OF INVESTIGATOR DETECTIVE TDP DAVIS ID # 1965 AGENCY FWPD DIST/AREA D13 REPORT COMPLETE  YES  NO

|   |   |  |   |  |  |   |   |
|---|---|--|---|--|--|---|---|
| <b>SEAT POSITION</b><br>1-FRONT LEFT<br>2-FRONT CENTER<br>3-FRONT RIGHT<br>4-SECOND SEAT LEFT<br>5-SECOND SEAT CENTER<br>6-SECOND SEAT RIGHT<br>7-THIRD SEAT LEFT<br>8-THIRD SEAT CENTER<br>9-THIRD SEAT RIGHT<br>10-CARGO AREA<br>11-OUTSIDE VEHICLE<br>12-UNKNOWN | <b>SOLICITATION</b><br>INDICATES A PERSON'S DESIRE TO RECEIVE CONTACT FROM PERSONS SEEKING PROFESSIONAL EMPLOYMENT AS/FOR AN ATTORNEY, CHIROPRACTOR, PHYSICIAN, SURGEON, PRIVATE INVESTIGATOR, OR ANY OTHER PERSON REGISTERED OR LICENSED BY A HEALTH CARE REGULATORY AGENCY (Y=SOLEICIT, N=NO SOLICIT) | <b>EJECTED</b><br>1-NO<br>2-YES<br>3-YES, PARTIAL<br>4-NOT APPLICABLE<br>5-UNKNOWN | <b>RESTRAINT USED</b><br>1-SHOULDER & LAP BELT<br>2-SHOULDER BELT ONLY<br>3-LAP BELT ONLY<br>4-CHILD SEAT, FACING FORWARD<br>5-CHILD SEAT, FACING REAR<br>6-CHILD SEAT, UNKNOWN | <b>7-BOOSTER SEAT</b><br>8-NONE<br>9-OTHER<br>10-UNKNOWN | <b>AIRBAG</b><br>1-NOT APPLICABLE<br>2-NOT DEPLOYED<br>3-DEPLOYED, FRONT<br>4-DEPLOYED, SIDE<br>5-DEPLOYED, OTHER<br>6-UNKNOWN | <b>HELMET USE</b><br>1-WORN, DAMAGED<br>2-WORN, NOT DAMAGED<br>3-WORN, UNK. DAMAGE<br>4-NOT WORN<br>5-UNKNOWN IF WORN | <b>INJURY SEVERITY</b><br>K-KILLED<br>A-INCAPACITATING INJURY<br>B-NON INCAPACITATING INJURY<br>C-POSSIBLE INJURY<br>N-NOT INJURED<br>U-UNKNOWN |
|---|---|--|---|--|--|---|---|

UNIT # **1** TOWED DUE TO  YES  NO **DISABLING DAMAGE** VEHICLE REMOVED TO **1600 E LANCASTER** BY **ABC WRECKER**

| ITEM # | SEAT POSITION | COMPLETE ALL DATA ON ALL OCCUPANT'S NAMES, POSITIONS, RESTRAINTS USED, ETC. HOWEVER, IT IS NOT NECESSARY TO SHOW ADDRESSES UNLESS KILLED OR INJURED. | SOL | EJECTED | RESTRAINT USED | AIRBAG | HELMET | AGE | SEX | INJURY CODE |
|--------|---------------|--|-----|---------|----------------|--------|--------|-----|-----|-------------|
| 1      | 1             | SEE FRONT  | N   | 1       | 1              | 2      | 4      | 38  | M   | B           |
| 2      | 3             | RAGLAND, GARY 4601 GOLD ROCK FTW, TX. 76137  | N   | 1       | 9              | 1      | 4      | 45  | M   | C           |
| 3      |               |  |     |         |                |        |        |     |     |             |
| 4      |               |  |     |         |                |        |        |     |     |             |
| 5      |               |  |     |         |                |        |        |     |     |             |

UNIT # **2** TOWED DUE TO  YES  NO **DISABLING DAMAGE** VEHICLE REMOVED TO **1301 E NORTHSIDE DR** BY **FORT WORTH WRECKER**

| ITEM # | SEAT POSITION | COMPLETE ALL DATA ON ALL OCCUPANT'S NAMES, POSITIONS, RESTRAINTS USED, ETC. HOWEVER, IT IS NOT NECESSARY TO SHOW ADDRESSES UNLESS KILLED OR INJURED. | SOL | EJECTED | RESTRAINT USED | AIRBAG | HELMET | AGE | SEX | INJURY CODE |
|--------|---------------|--|-----|---------|----------------|--------|--------|-----|-----|-------------|
| 6      | 1             | SEE FRONT  | N   | 1       | 1              | 6      | 4      | 36  | M   | K           |
| 7      |               |  |     |         |                |        |        |     |     |             |
| 8      |               |  |     |         |                |        |        |     |     |             |
| 9      |               |  |     |         |                |        |        |     |     |             |
| 10     |               |  |     |         |                |        |        |     |     |             |

| PED., PEDAL, MOT., CONVEY, ETC. | COMPLETED IF CASUALTIES NOT IN MOTOR VEHICLE | CASUALTY NAME (LAST, FIRST, MI) | ADDRESS | SOL | ALCOHOL SPECIMEN TAKEN | RESULT | DRUG SPECIMEN TAKEN | RESULT | HELMET | AGE | SEX | INJURY CODE |
|---------------------------------|--|---------------------------------|---------|-----|------------------------|--------|---------------------|--------|--------|-----|-----|-------------|
|                                 |  |                                 |         |     |                        |        |                     |        |        |     |     |             |

| ITEM #S | TAKEN TO        | BY                  | IF AMBULANCE USED, SHOW |                       |                  |                                  |  |
|---------|-----------------|---------------------|-------------------------|-----------------------|------------------|----------------------------------|--|
|         |                 |                     | TIME NOTIFIED           | TIME ARRIVED AT SCENE | AMBULANCE UNIT # | # OF ATTENDANTS INCLUDING DRIVER | # OF PERSONS TRANSPORTED FOR TREATMENT |
| 1       | HARRIS DOWNTOWN | MED-STAR 49         | 5:38P                   | 5:43P                 | 49               | 2                                |  |
| 6       | TCME OFFICE     | WL LAWSON FOUNDATIO | 1930                    | 2000                  |                  | 2                                | 1                                      |

COMPLETE THIS SECTION IF PERSON KILLED (If a driver or occupant dies within 30 days of the crash, please complete this area and mail the supplement to the Crash Records Bureau)

| ITEM # | DATE OF DEATH | TIME OF DEATH | ITEM # | DATE OF DEATH | TIME OF DEATH | ITEM # | DATE OF DEATH | TIME OF DEATH | ITEM # | DATE OF DEATH | TIME OF DEATH |
|--------|---------------|---------------|--------|---------------|---------------|--------|---------------|---------------|--------|---------------|---------------|
| 6      | 071009        | 1735          |        |               |               |        |               |               |        |               |               |

INVESTIGATOR'S NARRATIVE OPINION OF WHAT HAPPENED (ATTACH ADDITIONAL SHEETS IF NECESSARY)

Unit 1 was E/B 2350 NE Loop 820 in left lane. Driver 1 said unit 2 slammed on brakes. Unit 2 was struck by unit 1. Unit 2 then struck unit 3. Unit 5 states unit 4 who was behind him was driving fast and he tried to move out of the way and was then rear ended by unit 4. Driver unit 2 was deceased on the scene.

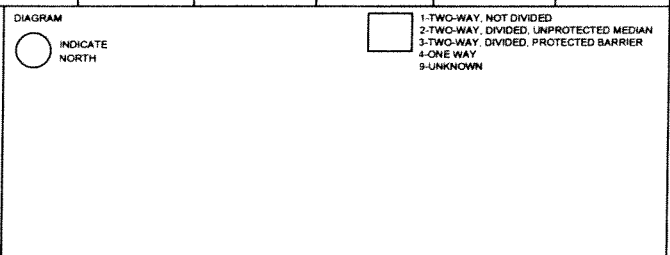

FACTORS AND CONDITIONS LISTED ARE THE INVESTIGATOR'S OPINION

| UNIT # | FACTORS/CONDITIONS CONTRIBUTING | OTHER FACTORS/CONDITIONS MAY OR MAY NOT HAVE CONTRIBUTED | VEHICLE DEFECTS CONTRIBUTING | VEHICLE DEFECTS MAY HAVE CONTRIBUTED |
|--------|---------------------------------|--|------------------------------|--------------------------------------|
| 1      | 22                              |  |                              |                                      |

- 1-ANIMAL ON ROAD - DOMESTIC
- 2-ANIMAL ON ROAD - WILD
- 3-BACKED WITHOUT SAFETY
- 4-CHANGED LANE WHEN UNSAFE
- 5-13 SEE VEHICLE DEFECTS
- 14-DISABLED IN TRAFFIC LANE
- 15-DISREGARD STOP AND GO SIGNAL
- 16-DISREGARD STOP SIGN OR LIGHT
- 17-DISREGARD TURN MARKS AT INTERSECTION
- 18-DISREGARD WARNING SIGN AT CONSTRUCTION
- 19-DISTRACTION IN VEHICLE
- 20-DRIVER INATTENTION
- 21-DRIVE WITHOUT HEADLIGHTS
- 22-FAILED TO CONTROL SPEED
- 23-FAILED TO DRIVE IN SINGLE LANE
- 24-FAILED TO GIVE HALF OF ROADWAY
- 25-FAILED TO NEED WARNING SIGN
- 26-FAILED TO PASS TO LEFT SAFELY
- 27-FAILED TO PASS TO RIGHT SAFELY
- 28-FAILED TO GIVE SIGNAL OR WRONG SIGNAL
- 29-FAILED TO STOP AT PROPER PLACE
- 30-FAILED TO STOP FOR SCHOOL BUS
- 31-FAILED TO STOP FOR TRAIN
- 32-FAILED TO YIELD ROW - EMERGENCY VEHICLE
- 33-FAILED TO YIELD ROW - OPEN INTERSECTION
- 34-FAILED TO YIELD ROW - PRIVATE DRIVE
- 35-FAILED TO YIELD ROW - STOP SIGN
- 36-FAILED TO YIELD ROW - TO PEDESTRIAN
- 37-FAILED TO YIELD ROW - TURNING LEFT
- 38-FAILED TO YIELD ROW - TURN ON RED
- 39-FAILED TO YIELD ROW - YIELD SIGN
- 40-FATIGUED OR ASLEEP
- 41-FAULTY EVASIVE ACTION
- 42-FIRE IN VEHICLE
- 43-FLEEING OR EVADING POLICE
- 44-FOLLOWED TOO CLOSELY
- 45-HAD BEEN DRINKING
- 46-HANDICAPPED DRIVER (EXP. IN NARRATIVE)
- 47-ILL (EXP. IN NARRATIVE)
- 48-IMPARED VISIBILITY (EXP. IN NARRATIVE)
- 49-IMPROPER START FROM PARKED POSITION
- 50-LOAD NOT SECURED
- 51-OPENED DOOR INTO TRAFFIC LANE
- 52-OVERSIZE VEHICLE OR LOAD
- 53-OVERTAKE AND PASS INSUFFICIENT CLEARANCE
- 54-PARKED AND FAILED TO SET BRAKES
- 55-PARKED IN TRAFFIC LANE
- 56-PARKED WITHOUT LIGHTS
- 57-PASSED IN NO PASSING ZONE
- 58-PASSED ON RIGHT SHOULDER
- 59-PEDAL/MOT. CON. FTYROW TO VEHICLE
- 60-SPEEDING-UNSAFE (UNDER LIMIT)
- 61-SPEEDING-OVER LIMIT
- 62-TAKING MEDICATION (EXP. IN NARRATIVE)
- 63-TURNED IMPROPERLY - CUT CORNER ON LEFT
- 64-TURNED IMPROPERLY - WIDE RIGHT
- 65-TURNED IMPROPERLY - WRONG LANE
- 66-TURNED WHEN UNSAFE
- 67-UNDER INFLUENCE - ALCOHOL
- 68-UNDER INFLUENCE - DRUG
- 69-WRONG SIDE APPROACH OR IN INTERSECTION
- 70-WRONG SIDE NOT PASSING
- 71-WRONG WAY - ONE WAY ROAD
- 72-CELLMOBILE PHONE USE
- 73-ROAD RAGE
- 74-OTHER FACTOR (WRITE ON LINE)

- VEHICLE DEFECTS**
- 5-DEFECTIVE OR NO HEADLAMPS
  - 9-DEFECTIVE OR NO STOP LAMPS
  - 7-DEFECTIVE OR NO TAIL LAMPS
  - 8-DEFECTIVE OR NO TURN SIG. LAMPS
  - 10-DEFECTIVE OR NO TRAILER BRAKES
  - 10-DEFECTIVE OR NO VEHICLE BRAKES
  - 11-DEFECTIVE OR NO STEERING MECH
  - 12-DEFECTIVE OR SLICK TIRES
  - 13-DEFECTIVE TRUCK HITCH

| TRAFFIC CONTROL  | ROADWAY RELATION  | PART OF ROADWAY   | ROADWAY ALIGNMENT   | LIGHT CONDITION   | TYPE OF ROAD SURFACE  | WEATHER   | SURFACE CONDITION  |
|--|---|---|---|---|---|---|--|
| 1-NONE<br>2-NONOPERATIVE<br>3-FLASHER<br>4-FLASHER<br>5-SIGNAL LIGHT<br>6-FLASHING RED LIGHT | 7-FLASHING YELLOW LIGHT<br>8-STOP SIGN<br>9-YIELD SIGN<br>10-WARNING SIGN<br>11-CENTER STRIPPED DIVIDER<br>12-NO PASSING ZONE | 13-RR GATE/SIGNAL<br>14-SCHOOL ZONE<br>15-CROSSWALK<br>16-BIKE LANE<br>17-OTHER | 1-STRAIGHT LEVEL<br>2-STRAIGHT GRADE<br>3-STRAIGHT HILLCREST<br>4-CURVE LEVEL<br>5-CURVE GRADE<br>6-CURVE HILLCREST<br>7-OTHER<br>8-UNKNOWN | 1-DAYLIGHT<br>2-DARK, NOT LIGHTED<br>3-DARK, LIGHTED<br>4-DARK, UNK. LIGHTED<br>5-DAWN<br>6-DUSK<br>7-OTHER<br>8-UNKNOWN<br>9-UNKNOWN | 1-CONCRETE<br>2-BLACKTOP<br>3-BROCK<br>4-GRAVEL<br>5-DIRT<br>6-OTHER<br>7-UNKNOWN | 1-CLEAR/LOUDLY<br>2-RAIN<br>3-SLEET/RAIL<br>4-SNOW<br>5-FOG<br>6-BLOWING SAND/SNOW<br>7-SEVERE CROSSWINDS<br>8-OTHER<br>9-UNKNOWN | 1-DRY<br>2-SAND/MUD/DIRT<br>3-WET<br>4-STANDING WATER/PUNK<br>5-SLUSH<br>6-ICE |

FATAL    CMV INVOLVED    SCHOOL BUS RELATED    RAILROAD RELATED    MEDICAL ADVISORY BOARD    HIT AND RUN    AMENDMENT/SUPPLEMENT



# Texas Peace Officer's Crash Report

Form CR-3  
(Rev. 03/09)  
Page 1 of 2

Submission of Crash Records: This report may be submitted via the CRIS Web Portal, electronically submitted via XML, or by mailing to the Texas Department of Transportation, Crash Records, PO Box 149349, Austin, TX 78714.  
Questions? Call: 512/486-5780

PLACE WHERE CRASH OCCURRED  
 COUNTY TARRANT CITY OR TOWN FORT WORTH  
 IF CRASH WAS OUTSIDE CITY LIMITS INDICATE FROM NEAREST TOWN \_\_\_\_\_ MILES     OF \_\_\_\_\_  
 LOC # 09-076903  
 ORI # \_\_\_\_\_  
 TxDOT # \_\_\_\_\_

ROAD ON WHICH CRASH OCCURRED 2350 NE LOOP 820 CONSTRUCTION ZONE  YES  NO SPEED LIMIT 65  
 BLOCK NUMBER STREET OR ROAD NAME ROUTE NUMBER OR STREET CODE WORKERS PRESENT  YES  NO  
 INTERSECTING STREET OR RR X'ING NUMBER \_\_\_\_\_ CONSTRUCTION ZONE  YES  NO SPEED LIMIT \_\_\_\_\_  
 BLOCK NUMBER STREET OR ROAD NAME ROUTE NUMBER OR STREET CODE WORKERS PRESENT  YES  NO  
 NOT AT INTERSECTION 100  FT.     OF 5300 MARK IV PARKWAY MILEPOST \_\_\_\_\_  
 MI. N S E W SHOW MILEPOST OR NEAREST INTERSECTING NUMBERED HIGHWAY IF NONE, SHOW NEAREST INTERSECTING STREET OR REFERENCE POINT LATITUDE \_\_\_\_\_  
 LONGITUDE \_\_\_\_\_

DATE OF CRASH JULY 10 2009 DAY OF WEEK FRIDAY HOUR 5:35  
 MONTH DAY YEAR  
 AM # EXACTLY NOON  
 PM OR MIDNIGHT, 50 STATE

UNIT # 3 1 1-MOTOR VEHICLE 4-PEDESTRIAN 7-NON-CONTACT 8-OTHER VIN # 2CNDL63F966034560 ALTERED VEHICLE HEIGHT  YES  NO  
 2-TRAIN 5-MOTORIZED CONVEYANCE 8-OTHER  
 3-PEDALCYCLIST 6-TOWED  
 YEAR MODEL 06 COLOR & MAKE MAROON - CHEVY MODEL NAME EQUINOX BODY STYLE SUV LICENSE PLATE 09 TX BMN903  
 YEAR STATE NUMBER  
 DRIVER'S NAME HORN PAUL D 9025 BAYARD ST KELLER, TX. 76248 PHONE NUMBER \_\_\_\_\_  
 LAST FIRST M.I. ADDRESS (STREET, CITY, STATE, ZIP)

DRIVER'S LICENSE TX 19640406 CM 04/06/1964 LICENSE STATUS 1 1-VALID 4-CANCELLED/DENIED  
 STATE NUMBER CLASS/TYPE ENDORSEMENTS RESTRICTIONS DATE OF BIRTH STATUS 2-NOT VALID 5-EXPIRED  
 3-SUSPENDED/REVOKED 6-UNKNOWN

DRIVER'S ETHNICITY 1 1-WHITE 4-ASIAN DRIVER'S SEX  MALE  FEMALE DRIVER'S OCCUPATION \_\_\_\_\_ POLICE, FIREFIGHTER, EMS, ON EMERGENCY  IF CHECKED, PLEASE EXPLAIN IN NARRATIVE  
 2-HISPANIC 5-OTHER  
 3-BLACK

TYPE OF ALCOHOL SPECIMEN TAKEN 4 TEST RESULTS \_\_\_\_\_ TYPE OF DRUG SPECIMEN TAKEN 3 TEST RESULTS \_\_\_\_\_ DRUG CATEGORY 1. \_\_\_\_\_  
 1-BREATH 2-BLOOD 3-URINE 4-NONE 5-REFUSED 1-BLOOD 2-URINE 3-NONE 4-REFUSED 2. \_\_\_\_\_

LESSEE  OWNER SAME AS DRIVER  
 NAME (ALWAYS SHOW LESSEE IF LEASED, OTHERWISE SHOW OWNER) ADDRESS (STREET, CITY, STATE, ZIP)

LIABILITY INSURANCE  YES  NO PROGRESSIVE INS 62491286 VEHICLE DAMAGE RATING 06,VB7,BD4,FD4  
 EXP INSURANCE COMPANY POLICY NUMBER

UNIT # 4 1 1-MOTOR VEHICLE 4-PEDESTRIAN 7-NON-CONTACT 8-OTHER VIN # 1D7HA16K62J219983 ALTERED VEHICLE HEIGHT  YES  NO  
 2-TRAIN 5-MOTORIZED CONVEYANCE 8-OTHER  
 3-PEDALCYCLIST 6-TOWED  
 YEAR MODEL 02 COLOR & MAKE BLUE - DODGE MODEL NAME 1500 BODY STYLE P/U LICENSE PLATE 09 TX 55RFT2  
 YEAR STATE NUMBER  
 DRIVER'S NAME DIAL TRACY N 1235 GILLILAND RD SPRINGTOWN, TX. 76082 PHONE NUMBER 817-614-0608  
 LAST FIRST M.I. ADDRESS (STREET, CITY, STATE, ZIP)

DRIVER'S LICENSE TX 13714203 C 12/20/1984 LICENSE STATUS 1 1-VALID 4-CANCELLED/DENIED  
 STATE NUMBER CLASS/TYPE ENDORSEMENTS RESTRICTIONS DATE OF BIRTH STATUS 2-NOT VALID 5-EXPIRED  
 3-SUSPENDED/REVOKED 6-UNKNOWN

DRIVER'S ETHNICITY 1 1-WHITE 4-ASIAN DRIVER'S SEX  MALE  FEMALE DRIVER'S OCCUPATION \_\_\_\_\_ POLICE, FIREFIGHTER, EMS, ON EMERGENCY  IF CHECKED, PLEASE EXPLAIN IN NARRATIVE  
 2-HISPANIC 5-OTHER  
 3-BLACK

TYPE OF ALCOHOL SPECIMEN TAKEN 4 TEST RESULTS \_\_\_\_\_ TYPE OF DRUG SPECIMEN TAKEN 3 TEST RESULTS \_\_\_\_\_ DRUG CATEGORY 1. \_\_\_\_\_  
 1-BREATH 2-BLOOD 3-URINE 4-NONE 5-REFUSED 1-BLOOD 2-URINE 3-NONE 4-REFUSED 2. \_\_\_\_\_

LESSEE  OWNER SAME AS DRIVER  
 NAME (ALWAYS SHOW LESSEE IF LEASED, OTHERWISE SHOW OWNER) ADDRESS (STREET, CITY, STATE, ZIP)

LIABILITY INSURANCE  YES  NO STATE FARM 4332595686002 VEHICLE DAMAGE RATING 06,BD3,FD,2,RP2  
 EXP INSURANCE COMPANY POLICY NUMBER

DAMAGE TO PROPERTY OTHER THAN VEHICLES \_\_\_\_\_

OBJECT \_\_\_\_\_ NAME AND ADDRESS OF OWNER \_\_\_\_\_ FEET FROM CURB \_\_\_\_\_ \$ \_\_\_\_\_ DAMAGE ESTIMATE \_\_\_\_\_

IN YOUR OPINION, DID THIS CRASH RESULT IN AT LEAST \$1,000.00 DAMAGE TO ANY ONE PERSON'S PROPERTY?  YES  NO

CHARGES FILED  
 NAME \_\_\_\_\_ CHARGE \_\_\_\_\_ CITATION # \_\_\_\_\_  
 NAME \_\_\_\_\_ CHARGE \_\_\_\_\_ CITATION # \_\_\_\_\_

TIME NOTIFIED OF CRASH 07/10/09 6:23P HOW POLICE RADIO TIME ARRIVED AT SCENE 07/10/09 6:53P DATE OF REPORT 07/11/09  
 DATE HOUR DATE HOUR

TYPED OR PRINTED NAME OF INVESTIGATOR DETECTIVE TDP DAVIS ID # 1965 AGENCY FWOP DIST/AREA D13 REPORT COMPLETE  YES  NO

|   |  |   |  |  |  |   |  |  |  |   |  |   |  |  |  |  |  |
|---|--|---|--|--|--|---|--|--|--|---|--|---|--|--|--|--|--|
| SEAT POSITION<br>1-FRONT LEFT<br>2-FRONT CENTER<br>3-FRONT RIGHT<br>4-SECOND SEAT LEFT<br>5-SECOND SEAT CENTER<br>6-SECOND SEAT RIGHT |  | 7-THIRD SEAT LEFT<br>8-THIRD SEAT CENTER<br>9-THIRD SEAT RIGHT<br>10-CARGO AREA<br>11-OUTSIDE VEHICLE<br>12-UNKNOWN |  | SOLICITATION<br>INDICATES A PERSON'S DESIRE TO RECEIVE CONTACT FROM PERSONS SEEKING PROFESSIONAL EMPLOYMENT AS/FOR AN ATTORNEY, CHIROPRACTOR, PHYSICIAN, SURGEON, PRIVATE INVESTIGATOR, OR ANY OTHER PERSON REGISTERED OR LICENSED BY A HEALTH CARE REGULATORY AGENCY (Y=SOLEICIT, N=NO SOLICIT) |  | EJECTED<br>1-NONE<br>2-YES<br>3-YES, PARTIAL<br>4-NOT APPLICABLE<br>5-UNKNOWN |  | RESTRAINT USED<br>1-SHOULDER & LAP BELT<br>2-SHOULDER BELT ONLY<br>3-LAP BELT ONLY<br>4-CHILD SEAT, FACING FORWARD<br>5-CHILD SEAT, FACING REAR<br>6-CHILD SEAT, UNKNOWN |  | 7-BOOSTER SEAT<br>8-NONE<br>9-OTHER<br>10-UNKNOWN |  | AIRBAG<br>1-NOT APPLICABLE<br>2-NOT DEPLOYED<br>3-DEPLOYED, FRONT<br>4-DEPLOYED, SIDE<br>5-DEPLOYED, OTHER<br>6-UNKNOWN |  | HELMET USE<br>1-WORN, DAMAGED<br>2-WORN, NOT DAMAGED<br>3-WORN, UNK. DAMAGE<br>4-NOT WORN<br>5-UNKNOWN IF WORN |  | INJURY SEVERITY<br>A-KILLED<br>B-INCAPACITATING INJURY<br>C-NON INCAPACITATING INJURY<br>D-POSSIBLE INJURY<br>E-NOT INJURED<br>F-UNKNOWN |  |
|---|--|---|--|--|--|---|--|--|--|---|--|---|--|--|--|--|--|

UNIT # **3** TOWED DUE TO  YES  NO VEHICLE REMOVED TO **1301 E NORTHSIDE DR** BY **WESTLOOP TOWING**

| ITEM # | SEAT POSITION | COMPLETE ALL DATA ON ALL OCCUPANT'S NAMES, POSITIONS, RESTRAINTS USED, ETC. HOWEVER, IT IS NOT NECESSARY TO SHOW ADDRESSES UNLESS KILLED OR INJURED | ADDRESS | SOL | EJECTED | RESTRAINT USED | AIRBAG | HELMET | AGE | SEX | INJURY CODE |
|--------|---------------|---|---------|-----|---------|----------------|--------|--------|-----|-----|-------------|
| 1      | 1             | SEE FRONT   |         | N   | 1       | 1              | 6      | 4      | 44  | M   | B           |
| 2      |               |   |         |     |         |                |        |        |     |     |             |
| 3      |               |   |         |     |         |                |        |        |     |     |             |
| 4      |               |   |         |     |         |                |        |        |     |     |             |
| 5      |               |   |         |     |         |                |        |        |     |     |             |

UNIT # **4** TOWED DUE TO  YES  NO VEHICLE REMOVED TO **1301 E NORTHSIDE DR** BY **ABC WRECKER**

| ITEM # | SEAT POSITION | COMPLETE ALL DATA ON ALL OCCUPANT'S NAMES, POSITIONS, RESTRAINTS USED, ETC. HOWEVER, IT IS NOT NECESSARY TO SHOW ADDRESSES UNLESS KILLED OR INJURED | ADDRESS | SOL | EJECTED | RESTRAINT USED | AIRBAG | HELMET | AGE | SEX | INJURY CODE |
|--------|---------------|---|---------|-----|---------|----------------|--------|--------|-----|-----|-------------|
| 6      | 1             | SEE FRONT   |         | N   | 1       | 1              | 2      | 4      | 23  | F   | B           |
| 7      | 3             | PARKS, SHAWNA   |         | N   | 1       | 1              | 2      | 4      |     | F   | B           |
| 8      |               |   |         |     |         |                |        |        |     |     |             |
| 9      |               |   |         |     |         |                |        |        |     |     |             |
| 10     |               |   |         |     |         |                |        |        |     |     |             |

| PED., PEDAL, MOT. CONVEY, ETC. | COMPLETED IF CASUALTIES NOT IN MOTOR VEHICLE | CASUALTY NAME (LAST, FIRST, MI) | ADDRESS | SOL | ALCOHOL SPECIMEN TAKEN | RESULT | DRUG SPECIMEN TAKEN | RESULT | HELMET | AGE | SEX | INJURY CODE |
|--------------------------------|--|---------------------------------|---------|-----|------------------------|--------|---------------------|--------|--------|-----|-----|-------------|
|                                |  |                                 |         |     |                        |        |                     |        |        |     |     |             |

| DISPOSITION OF KILLED OR INJURED |                   |          |               | IF AMBULANCE USED, SHOW |                  |                                  |  |  |
|----------------------------------|-------------------|----------|---------------|-------------------------|------------------|----------------------------------|--|--|
| ITEM #S                          | TAKEN TO          | BY       | TIME NOTIFIED | TIME ARRIVED AT SCENE   | AMBULANCE UNIT # | # OF ATTENDANTS INCLUDING DRIVER | # OF PERSONS TRANSPORTED FOR TREATMENT |  |
| 1                                | HARRIS HOSPITAL   | MED STAR | 5:46P         | 5:52P                   | 60               | 2                                | 3                                      |  |
| 6&7                              | PARKLAND MEM HOSP | MED STAR | 5:45P         | 5:49P                   | 43               | 2                                |  |  |

COMPLETE THIS SECTION IF PERSON KILLED (If a driver or occupant dies within 30 days of the crash, please complete this area and mail the supplement to the Crash Records Bureau)

| ITEM # | DATE OF DEATH | TIME OF DEATH | ITEM # | DATE OF DEATH | TIME OF DEATH | ITEM # | DATE OF DEATH | TIME OF DEATH | ITEM # | DATE OF DEATH | TIME OF DEATH |
|--------|---------------|---------------|--------|---------------|---------------|--------|---------------|---------------|--------|---------------|---------------|
|        |               |               |        |               |               |        |               |               |        |               |               |

INVESTIGATOR'S NARRATIVE OPINION OF WHAT HAPPENED (ATTACH ADDITIONAL SHEETS IF NECESSARY)

\_\_\_\_\_

\_\_\_\_\_

\_\_\_\_\_

\_\_\_\_\_

\_\_\_\_\_

\_\_\_\_\_

\_\_\_\_\_

\_\_\_\_\_

\_\_\_\_\_

\_\_\_\_\_

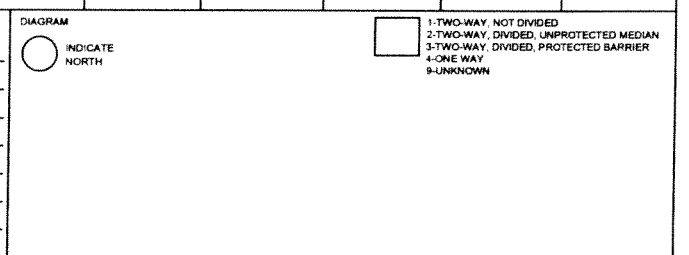

FACTORS AND CONDITIONS LISTED ARE THE INVESTIGATOR'S OPINION

| UNIT # | FACTORS/CONDITIONS CONTRIBUTING | OTHER FACTORS/CONDITIONS MAY OR MAY NOT HAVE CONTRIBUTED | VEHICLE DEFECTS CONTRIBUTING | VEHICLE DEFECTS MAY HAVE CONTRIBUTED |
|--------|---------------------------------|--|------------------------------|--------------------------------------|
| 1      | 1                               | 2  | 3                            | 4                                    |
| 1      | 2                               | 3  | 4                            | 5                                    |

- 1-ANIMAL ON ROAD - DOMESTIC  
2-ANIMAL ON ROAD - WILD  
3-BACKED WITHOUT SAFETY  
4-CHANGED LANE WHEN UNSAFE  
5-13 SEE VEHICLE DEFECTS  
14-DISABLED IN TRAFFIC LANE  
15-DISREGARD STOP AND GO SIGNAL  
16-DISREGARD STOP SIGN OR LIGHT  
17-DISREGARD TURN MARKS AT INTERSECTION  
18-DISREGARD WARNING SIGN AT CONSTRUCTION  
19-DISTRACTION IN VEHICLE  
20-DRIVER INATTENTION  
21-DROVE W/OUT HEADLIGHTS  
22-FAILED TO CONTROL SPEED  
23-FAILED TO DRIVE IN SINGLE LANE  
24-FAILED TO GIVE HALF OF ROADWAY  
25-FAILED TO HEED WARNING SIGN  
26-FAILED TO PASS TO LEFT SAFELY  
27-FAILED TO PASS TO RIGHT SAFELY  
28-FAILED TO GIVE SIGNAL OR WRONG SIGNAL  
29-FAILED TO STOP AT PROPER PLACE  
30-FAILED TO STOP FOR SCHOOL BUS  
31-FAILED TO STOP FOR TRAIN  
32-FAILED TO YIELD ROW - EMERGENCY VEHICLE  
33-FAILED TO YIELD ROW - OPEN INTERSECTION  
34-FAILED TO YIELD ROW - PRIVATE DRIVE  
35-FAILED TO YIELD ROW - STOP SIGN  
36-FAILED TO YIELD ROW - TO PEDESTRIAN  
37-FAILED TO YIELD ROW - TURNING LEFT  
38-FAILED TO YIELD ROW - TURN ON RED  
39-FAILED TO YIELD ROW - YIELD SIGN
- 40-FATIGUED OR ASLEEP  
41-FAULTY EVASIVE ACTION  
42-FIRE IN VEHICLE  
43-FLEEING OR EVADING POLICE  
44-FOLLOWED TOO CLOSELY  
45-HAD BEEN DRIVING  
46-HANDICAPPED DRIVER (EXP. IN NARRATIVE)  
47-ILL (EXP. IN NARRATIVE)  
48-IMPARED VISIBILITY (EXP. IN NARRATIVE)  
49-IMPROPER START FROM PARKED POSITION  
50-LOAD NOT SECURED  
51-OPENED DOOR INTO TRAFFIC LANE  
52-OVERSIZE VEHICLE OR LOAD  
53-OVERTAKE AND PASS INSUFFICIENT CLEARANCE  
54-PARKED AND FAILED TO SET BRAKES  
55-PARKED IN TRAFFIC LANE  
56-PARKED WITHOUT LIGHTS  
57-PASSED IN NO PASSING ZONE  
58-PASSED ON RIGHT SHOULDER  
59-PEDAL MOT. CON. FTYROW TO VEHICLE  
60-SPEDING-UNSAFE (UNDER LIMIT)  
61-SPEDING OVER LIMIT  
62-TAKING MEDICATION (EXP. IN NARRATIVE)  
63-TURNED IMPROPERLY - CUT CORNER ON LEFT  
64-TURNED IMPROPERLY - WIDE RIGHT  
65-TURNED IMPROPERLY - WRONG LANE  
66-TURNED WHEN UNSAFE  
67-PASSED ON RIGHT SHOULDER  
68-UNDER INFLUENCE - ALCOHOL  
69-UNDER INFLUENCE - DRUG  
70-WRONG SIDE APPROACH OR IN INTERSECTION  
71-WRONG SIDE NOT PASSING
- 71-WRONG WAY - ONE WAY ROAD  
72-CELL/MOBILE PHONE USE  
73-ROAD RAGE  
74-OTHER FACTOR (WRITE ON LINE)

VEHICLE DEFECTS

5-DEFECTIVE OR NO HEADLAMPS  
6-DEFECTIVE OR NO STOP LAMPS  
7-DEFECTIVE OR NO TAIL LAMPS  
8-DEFECTIVE OR NO TURN SIG LAMPS  
9-DEFECTIVE OR NO TRAILER BRAKES  
10-DEFECTIVE OR NO VEHICLE BRAKES  
11-DEFECTIVE OR NO STEERING MECH  
12-DEFECTIVE OR SLICK TIRES  
13-DEFECTIVE TRAILER HITCH

|  |   |   |
|--|---|---|
| <p>TRAFFIC CONTROL</p> <p>1-NONE<br/>2-INOPERATIVE<br/>3-OFFICER<br/>4-FLAGMAN<br/>5-SIGNAL LIGHT<br/>6-FLASHING RED LIGHT</p> <p>7-FLASHING YELLOW LIGHT<br/>8-STOP SIGN<br/>9-YIELD SIGN<br/>10-WARNING SIGN<br/>11-CENTER STRIPED DIVIDER<br/>12-NO PASSING ZONE</p> <p>13-RR GATE/SIGNAL<br/>14-SCHOOL ZONE<br/>15-CROSSWALK<br/>16-BIKE LANE<br/>17-OTHER</p> <p>11</p> | <p>ROADWAY RELATION</p> <p>1-ON ROADWAY<br/>2-OFF ROADWAY<br/>3-SHOULDER<br/>4-MEDIAN</p> <p>1</p>  |   |
| <p>PART OF ROADWAY</p> <p>1-MAIN LANE<br/>2-SERVICE ROAD<br/>3-ENTRANCE RAMP<br/>4-EXIT RAMP<br/>5-CONNECTOR<br/>6-TOUR<br/>7-OTHER</p> <p>1</p>   | <p>ROADWAY ALIGNMENT</p> <p>1-STRAIGHT, LEVEL<br/>2-STRAIGHT, GRADE<br/>3-STRAIGHT, HILLCREST<br/>4-CURVE, LEVEL<br/>5-CURVE, GRADE<br/>6-CURVE, HILLCREST<br/>7-OTHER<br/>8-UNKNOWN</p> <p>3</p> | <p>LIGHT CONDITION</p> <p>1-DAYLIGHT<br/>2-DARK, NOT LIGHTED<br/>3-DARK, LIGHTED<br/>4-DARK, UNLIGHTED<br/>5-DAWN<br/>6-DUSK<br/>7-OTHER<br/>8-UNKNOWN</p> <p>1</p> |
| <p>TYPE OF ROAD SURFACE</p> <p>1-CONCRETE<br/>2-BLACKTOP<br/>3-BRICK<br/>4-GRAVEL<br/>5-DIRT<br/>6-OTHER<br/>7-UNKNOWN</p> <p>2</p>  | <p>WEATHER</p> <p>1-CLEAR/LOUDY<br/>2-RAIN<br/>3-SLEET/HAIL<br/>4-SNOW<br/>5-FOG<br/>6-BLOWING SAND/SNOW<br/>7-SEVERE CROSSWINDS<br/>8-OTHER<br/>9-UNKNOWN</p> <p>1</p>                           | <p>SURFACE CONDITION</p> <p>1-DRY<br/>2-WET<br/>3-STANDING WATER<br/>4-SNOW<br/>5-SLUSH<br/>6-ICE<br/>7-SAND/MUD/DIRT<br/>8-OTHER<br/>9-UNKNOWN</p> <p>1</p>        |

FATAL     CMV INVOLVED     SCHOOL BUS RELATED     RAILROAD RELATED     MEDICAL ADVISORY BOARD     HIT AND RUN     AMENDMENT/SUPPLEMENT



# Texas Peace Officer's Crash Report

Form CR-3  
(Rev. 03/09)  
Page 1 of 2

Submission of Crash Records: This report may be submitted via the CRIS Web Portal, electronically submitted via XML, or by mailing to the Texas Department of Transportation, Crash Records, PO Box 149349, Austin, TX 78714. Questions? Call: 512/486-5780

PLACE WHERE CRASH OCCURRED  
 COUNTY TARRANT CITY OR TOWN FORT WORTH  
 IF CRASH WAS OUTSIDE CITY LIMITS INDICATE FROM NEAREST TOWN \_\_\_\_\_ MILES  N  S  E  W OF \_\_\_\_\_  
 LOC # 09-076903  
 ORI # \_\_\_\_\_  
 TxDOT # \_\_\_\_\_

ROAD ON WHICH CRASH OCCURRED 2350 NE LOOP 820 CONSTRUCTION ZONE  YES  NO SPEED LIMIT 65  
 BLOCK NUMBER STREET OR ROAD NAME ROUTE NUMBER OR STREET CODE WORKERS PRESENT  YES  NO  
 INTERSECTING STREET OR RR X'ING NUMBER 100  FT.  MI.  N  S  E  W OF 5300 MARK IV PARKWAY CONSTRUCTION ZONE  YES  NO SPEED LIMIT \_\_\_\_\_  
 WORKERS PRESENT  YES  NO  
 NOT AT INTERSECTION 100  FT.  MI.  N  S  E  W OF 5300 MARK IV PARKWAY MILEPOST \_\_\_\_\_ LATITUDE \_\_\_\_\_  
 SHOW MILEPOST OR NEAREST INTERSECTING NUMBERED HIGHWAY IF NONE, SHOW NEAREST INTERSECTING STREET OR REFERENCE POINT LONGITUDE \_\_\_\_\_

DATE OF CRASH JULY 10 2009 DAY OF WEEK FRIDAY HOUR 5:35  AM  PM IF EXACTLY NOON OR MIDNIGHT, SO STATE

UNIT # 5  1-MOTOR VEHICLE 4-PEDESTRIAN 7-NON-CONTACT ALTERED VEHICLE HEIGHT  YES  NO  
 2-TRAIN 5-MOTORIZED CONVEYANCE 8-OTHER VIN # 2C3LA63H26H336630  
 3-PEDALCYCLIST 6-TOWED  
 YEAR MODEL 06 COLOR & MAKE BLACK CHRY MODEL NAME 300 C BODY STYLE 4DR LICENSE PLATE 10 TX 919KKG  
 DRIVER'S NAME ZAVALA ROBERT JR 2501 DURINGER RD FORT WORTH, TX 76133 PHONE NUMBER \_\_\_\_\_  
 LAST FIRST M.I. ADDRESS (STREET, CITY, STATE, ZIP)

DRIVER'S LICENSE TX 16346783 C 07/05/1976 LICENSE STATUS 1 1-VALID 4-CANCELLED/DENIED  
 STATE NUMBER CLASS/TYPE ENDORSEMENTS RESTRICTIONS DATE OF BIRTH STATUS 2-NOT VALID 5-EXPIRED  
 3-SUSPENDED/REVOKED 6-UNKNOWN

DRIVER'S ETHNICITY 2 1-WHITE 4-ASIAN DRIVER'S SEX  MALE  FEMALE DRIVER'S OCCUPATION \_\_\_\_\_ POLICE, FIREFIGHTER, EMS, ON EMERGENCY  IF CHECKED, PLEASE EXPLAIN IN NARRATIVE  
 2-HISPANIC 5-OTHER

TYPE OF ALCOHOL SPECIMEN TAKEN 4 TEST RESULTS \_\_\_\_\_ TYPE OF DRUG SPECIMEN TAKEN 3 TEST RESULTS \_\_\_\_\_ DRUG CATEGORY 1. \_\_\_\_\_  
 1-BREATH 2-BLOOD 3-URINE 4-NONE 5-REFUSED 1-BLOOD 2-URINE 3-NONE 4-REFUSED 2. \_\_\_\_\_

LESSEE  OWNER DANIEL MARTINEZ 3601 FULLER FT WORTH, TX 76133  
 NAME (ALWAYS SHOW LESSEE IF LEASED, OTHERWISE SHOW OWNER) ADDRESS (STREET, CITY, STATE, ZIP)

LIABILITY INSURANCE  YES  NO FARMERS TX COUNTY MUTUAL 68759945 VEHICLE DAMAGE RATING 06,BD-2  
 EXP INSURANCE COMPANY POLICY NUMBER

UNIT #  1-MOTOR VEHICLE 4-PEDESTRIAN 7-NON-CONTACT ALTERED VEHICLE HEIGHT  YES  NO  
 2-TRAIN 5-MOTORIZED CONVEYANCE 8-OTHER VIN # \_\_\_\_\_  
 3-PEDALCYCLIST 6-TOWED  
 YEAR MODEL \_\_\_\_\_ COLOR & MAKE \_\_\_\_\_ MODEL NAME \_\_\_\_\_ BODY STYLE \_\_\_\_\_ LICENSE PLATE \_\_\_\_\_  
 DRIVER'S NAME \_\_\_\_\_ PHONE NUMBER \_\_\_\_\_  
 LAST FIRST M.I. ADDRESS (STREET, CITY, STATE, ZIP)

DRIVER'S LICENSE \_\_\_\_\_ 1-VALID 4-CANCELLED/DENIED  
 STATE NUMBER CLASS/TYPE ENDORSEMENTS RESTRICTIONS DATE OF BIRTH STATUS 2-NOT VALID 5-EXPIRED  
 3-SUSPENDED/REVOKED 6-UNKNOWN

DRIVER'S ETHNICITY \_\_\_\_\_ 1-WHITE 4-ASIAN DRIVER'S SEX  MALE  FEMALE DRIVER'S OCCUPATION \_\_\_\_\_ POLICE, FIREFIGHTER, EMS, ON EMERGENCY  IF CHECKED, PLEASE EXPLAIN IN NARRATIVE  
 2-HISPANIC 5-OTHER

TYPE OF ALCOHOL SPECIMEN TAKEN \_\_\_\_\_ TEST RESULTS \_\_\_\_\_ TYPE OF DRUG SPECIMEN TAKEN \_\_\_\_\_ TEST RESULTS \_\_\_\_\_ DRUG CATEGORY 1. \_\_\_\_\_  
 1-BREATH 2-BLOOD 3-URINE 4-NONE 5-REFUSED 1-BLOOD 2-URINE 3-NONE 4-REFUSED 2. \_\_\_\_\_

LESSEE  OWNER \_\_\_\_\_  
 NAME (ALWAYS SHOW LESSEE IF LEASED, OTHERWISE SHOW OWNER) ADDRESS (STREET, CITY, STATE, ZIP)

LIABILITY INSURANCE  YES  NO \_\_\_\_\_ VEHICLE DAMAGE RATING \_\_\_\_\_  
 EXP INSURANCE COMPANY POLICY NUMBER

DAMAGE TO PROPERTY OTHER THAN VEHICLES \_\_\_\_\_

OBJECT \_\_\_\_\_ NAME AND ADDRESS OF OWNER \_\_\_\_\_ FEET FROM CURB \_\_\_\_\_ \$ \_\_\_\_\_ DAMAGE ESTIMATE \_\_\_\_\_

IN YOUR OPINION, DID THIS CRASH RESULT IN AT LEAST \$1,000.00 DAMAGE TO ANY ONE PERSON'S PROPERTY?  YES  NO

CHARGES FILED  
 NAME \_\_\_\_\_ CHARGE \_\_\_\_\_ CITATION # \_\_\_\_\_  
 NAME \_\_\_\_\_ CHARGE \_\_\_\_\_ CITATION # \_\_\_\_\_

TIME NOTIFIED OF CRASH 07/10/09 6:23P HOW POLICE RADIO TIME ARRIVED AT SCENE 07/10/09 6:53P DATE OF REPORT 07/11/09  
 DATE HOUR DATE HOUR

TYPED OR PRINTED NAME OF INVESTIGATOR DETECTIVE TDP DAVIS ID # 1965 AGENCY FWPD DIST/AREA D13 REPORT COMPLETE  YES  NO



|  |   |   |  |   |  |  |   |   |
|--|---|---|--|---|--|--|---|---|
| <b>SEAT POSITION</b><br>1-FRONT LEFT<br>2-FRONT CENTER<br>3-FRONT RIGHT<br>4-SECOND SEAT LEFT<br>5-SECOND SEAT CENTER<br>6-SECOND SEAT RIGHT | 7-THIRD SEAT LEFT<br>8-THIRD SEAT CENTER<br>9-THIRD SEAT RIGHT<br>10-CARGO AREA<br>11-OUTSIDE VEHICLE<br>12-UNKNOWN | <b>SOLICITATION</b><br>INDICATES A PERSON'S DESIRE TO RECEIVE CONTACT FROM PERSONS SEEKING PROFESSIONAL EMPLOYMENT AS/FOR AN ATTORNEY, CHIROPRACTOR, PHYSICIAN, SURGEON, PRIVATE INVESTIGATOR, OR ANY OTHER PERSON REGISTERED OR LICENSED BY A HEALTH CARE REGULATORY AGENCY (Y=SOLEICIT, N=NO SOLICIT) | <b>EJECTED</b><br>1-NO<br>2-YES<br>3-YES, PARTIAL<br>4-NOT APPLICABLE<br>5-UNKNOWN | <b>RESTRAINT USED</b><br>1-SHOULDER & LAP BELT<br>2-SHOULDER BELT ONLY<br>3-LAP BELT ONLY<br>4-CHILD SEAT, FACING FORWARD<br>5-CHILD SEAT, FACING REAR<br>6-CHILD SEAT, UNKNOWN | <b>7-BOOSTER SEAT</b><br>8-NONE<br>9-OTHER<br>10-UNKNOWN | <b>AIRBAG</b><br>1-NOT APPLICABLE<br>2-NOT DEPLOYED<br>3-DEPLOYED, FRONT<br>4-DEPLOYED, SIDE<br>5-DEPLOYED, OTHER<br>6-UNKNOWN | <b>HELMET USE</b><br>1-WORN, DAMAGED<br>2-WORN, NOT DAMAGED<br>3-WORN, UNK. DAMAGE<br>4-NOT WORN<br>5-UNKNOWN IF WORN | <b>INJURY SEVERITY</b><br>K-KILLED<br>A-INCAPACITATING INJURY<br>B-NON INCAPACITATING INJURY<br>C-POSSIBLE INJURY<br>N-NOT INJURED<br>U-UNKNOWN |
|--|---|---|--|---|--|--|---|---|

|        |   |  |                                       |                  |
|--------|---|--|---------------------------------------|------------------|
| UNIT # | 5 | TOWED DUE TO <input type="checkbox"/> YES<br>DISABLING DAMAGE <input checked="" type="checkbox"/> NO | VEHICLE REMOVED TO <b>DRIVEN AWAY</b> | BY <b>DRIVER</b> |
|--------|---|--|---------------------------------------|------------------|

| ITEM # | SEAT POSITION | COMPLETE ALL DATA ON ALL OCCUPANT'S NAMES, POSITIONS, RESTRAINTS USED, ETC. HOWEVER, IT IS NOT NECESSARY TO SHOW ADDRESSES UNLESS KILLED OR INJURED.<br>NAME (LAST, FIRST, MI) ADDRESS | SOL | EJECTED | RESTRANT USED | AIRBAG | HELMET | AGE | SEX | INJURY CODE |
|--------|---------------|--|-----|---------|---------------|--------|--------|-----|-----|-------------|
| 1      | 1             | SEE FRONT  | N   | 1       | 1             | 2      | 4      | 32  | M   | N           |
|        |               |  |     |         |               |        |        |     |     |             |
|        |               |  |     |         |               |        |        |     |     |             |
|        |               |  |     |         |               |        |        |     |     |             |
|        |               |  |     |         |               |        |        |     |     |             |
|        |               |  |     |         |               |        |        |     |     |             |

|        |  |   |                          |          |
|--------|--|---|--------------------------|----------|
| UNIT # |  | TOWED DUE TO <input type="checkbox"/> YES<br>DISABLING DAMAGE <input type="checkbox"/> NO | VEHICLE REMOVED TO _____ | BY _____ |
|--------|--|---|--------------------------|----------|

| ITEM # | SEAT POSITION | COMPLETE ALL DATA ON ALL OCCUPANT'S NAMES, POSITIONS, RESTRAINTS USED, ETC. HOWEVER, IT IS NOT NECESSARY TO SHOW ADDRESSES UNLESS KILLED OR INJURED.<br>NAME (LAST, FIRST, MI) ADDRESS | SOL | EJECTED | RESTRANT USED | AIRBAG | HELMET | AGE | SEX | INJURY CODE |
|--------|---------------|--|-----|---------|---------------|--------|--------|-----|-----|-------------|
|        |               |  |     |         |               |        |        |     |     |             |
|        |               |  |     |         |               |        |        |     |     |             |
|        |               |  |     |         |               |        |        |     |     |             |
|        |               |  |     |         |               |        |        |     |     |             |
|        |               |  |     |         |               |        |        |     |     |             |

| PED., PEDAL, MOT., CONVEY, ETC.<br>CASUALTY NAME (LAST, FIRST, MI) ADDRESS | SOL | ALCOHOL SPECIMEN TAKEN | RESULT | DRUG SPECIMEN TAKEN | RESULT | HELMET | AGE | SEX | INJURY CODE |
|--|-----|------------------------|--------|---------------------|--------|--------|-----|-----|-------------|
|  |     |                        |        |                     |        |        |     |     |             |
|  |     |                        |        |                     |        |        |     |     |             |
|  |     |                        |        |                     |        |        |     |     |             |
|  |     |                        |        |                     |        |        |     |     |             |

| DISPOSITION OF KILLED OR INJURED |          |    |               |                       |                  | IF AMBULANCE USED, SHOW          |  |  |  |
|----------------------------------|----------|----|---------------|-----------------------|------------------|----------------------------------|--|--|--|
| ITEM #                           | TAKEN TO | BY | TIME NOTIFIED | TIME ARRIVED AT SCENE | AMBULANCE UNIT # | # OF ATTENDANTS INCLUDING DRIVER | # OF PERSONS TRANSPORTED FOR TREATMENT |  |  |
|                                  |          |    |               |                       |                  |                                  |  |  |  |
|                                  |          |    |               |                       |                  |                                  |  |  |  |
|                                  |          |    |               |                       |                  |                                  |  |  |  |

| COMPLETE THIS SECTION IF PERSON KILLED (if a driver or occupant dies within 30 days of the crash, please complete this area and mail the supplement to the Crash Records Bureau) |               |               |        |               |               |        |               |               |        |               |               |
|--|---------------|---------------|--------|---------------|---------------|--------|---------------|---------------|--------|---------------|---------------|
| ITEM #   | DATE OF DEATH | TIME OF DEATH | ITEM # | DATE OF DEATH | TIME OF DEATH | ITEM # | DATE OF DEATH | TIME OF DEATH | ITEM # | DATE OF DEATH | TIME OF DEATH |
|  |               |               |        |               |               |        |               |               |        |               |               |
|  |               |               |        |               |               |        |               |               |        |               |               |

INVESTIGATOR'S NARRATIVE OPINION OF WHAT HAPPENED (ATTACH ADDITIONAL SHEETS IF NECESSARY)

---



---



---



---



---



---

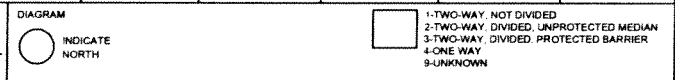

**FACTORS AND CONDITIONS LISTED ARE THE INVESTIGATOR'S OPINION**

| UNIT # | FACTORS/CONDITIONS CONTRIBUTING | OTHER FACTORS/CONDITIONS MAY OR MAY NOT HAVE CONTRIBUTED | VEHICLE DEFECTS CONTRIBUTING | VEHICLE DEFECTS MAY HAVE CONTRIBUTED |
|--------|---------------------------------|--|------------------------------|--------------------------------------|
|        |                                 |  |                              |                                      |
|        |                                 |  |                              |                                      |

- |   |   |  |
|---|---|--|
| 1-ANIMAL ON ROAD - DOMESTIC<br>2-ANIMAL ON ROAD - WILD<br>3-BACKED WITHOUT SAFETY<br>4-CHANGED LANE WHEN UNSAFE<br>5-13 SEE VEHICLE DEFECTS<br>14-DISABLED IN TRAFFIC LANE<br>15-DISREGARD STOP SIGN OR SIGNAL<br>16-DISREGARD STOP SIGN OR LIGHT<br>17-DISREGARD TURN MARKS AT INTERSECTION<br>18-DISREGARD WARNING SIGN AT CONSTRUCTION<br>19-OBSTRUCTION IN VEHICLE<br>20-DRIVER INATTENTION<br>21-DROVE WITHOUT HEADLIGHTS<br>22-FAILED TO CONTROL SPEED<br>23-FAILED TO DRIVE IN SINGLE LANE<br>24-FAILED TO GIVE HALF OF ROADWAY<br>25-FAILED TO HEED WARNING SIGN<br>26-FAILED TO PASS TO LEFT SAFELY<br>27-FAILED TO PASS TO RIGHT SAFELY<br>28-FAILED TO GIVE SIGNAL OR WRONG SIGNAL<br>29-FAILED TO STOP AT PROPER PLACE<br>30-FAILED TO STOP FOR SCHOOL BUS<br>31-FAILED TO STOP FOR TRAIN<br>32-FAILED TO YIELD ROW - EMERGENCY VEHICLE<br>33-FAILED TO YIELD ROW - OPEN INTERSECTION<br>34-FAILED TO YIELD ROW - PRIVATE DRIVE<br>35-FAILED TO YIELD ROW - STOP SIGN<br>36-FAILED TO YIELD ROW - TO PEDESTRIAN<br>37-FAILED TO YIELD ROW - TURNING LEFT<br>38-FAILED TO YIELD ROW - TURN ON RED<br>39-FAILED TO YIELD ROW - YIELD SIGN | 40-FATIGUED OR ASLEEP<br>41-FATALY EVASIVE ACTION<br>42-FIRE IN VEHICLE<br>43-FLEEING OR EVADING POLICE<br>44-FOLLOWED TOO CLOSELY<br>45-HAD BEEN DRIVING<br>46-HANDICAPPED DRIVER (EXP. IN NARRATIVE)<br>47-ALL (EXP. IN NARRATIVE)<br>48-IMPAIRED VISIBILITY (EXP. IN NARRATIVE)<br>49-IMPROPER START FROM PARKED POSITION<br>50-LOAD NOT SECURED<br>51-OPENED DOOR INTO TRAFFIC LANE<br>52-OVERSIZE VEHICLE OR LOAD<br>53-OVERTAKE AND PASS INSUFFICIENT CLEARANCE<br>54-PARKED AND FAILED TO SET BRAKES<br>55-PARKED IN TRAFFIC LANE<br>56-PARKED WITHOUT LIGHTS<br>57-PASSED IN NO PASSING ZONE<br>58-PASSED ON RIGHT SHOULDER<br>59-PEDESTAL MOT. CON. FTYROW TO VEHICLE<br>60-SPEEDING-UNSAFE (UNDER LIMIT)<br>61-SPEEDING OVER LIMIT<br>62-TAKING MEDICATION (EXP. IN NARRATIVE)<br>63-TURNED IMPROPERLY - CUT CORNER ON LEFT<br>64-TURNED IMPROPERLY - WIDE RIGHT<br>65-TURNED IMPROPERLY - WRONG LANE<br>66-TURNED WHEN UNSAFE<br>67-UNDER INFLUENCE, ALCOHOL<br>68-UNDER INFLUENCE, DRUG<br>69-WRONG SIDE APPROACH OR IN INTERSECTION<br>70-WRONG SIDE NOT PASSING | 71-WRONG WAY - ONE WAY ROAD<br>72-CELLPHONE PHONE USE<br>73-ROAD RAGE<br>74-OTHER FACTOR (WRITE ON LINE) |
|---|---|--|

- VEHICLE DEFECTS**
- 1-DEFECTIVE OR NO HEADLAMPS
  - 2-DEFECTIVE OR NO STOP LAMPS
  - 3-DEFECTIVE OR NO TAIL LAMPS
  - 4-DEFECTIVE OR NO TURN SIG. LAMPS
  - 5-DEFECTIVE OR NO TRAILER BRAKES
  - 6-DEFECTIVE OR NO VEHICLE BRAKES
  - 7-DEFECTIVE OR NO STEERING MECH.
  - 8-DEFECTIVE OR SICK TIRES
  - 9-DEFECTIVE TRAILER HITCH

|  |   |  |  |
|--|---|--|--|
| <b>TRAFFIC CONTROL</b><br>1-NONE<br>2-INOPERATIVE<br>3-OFFICER<br>4-FLIC/SMAN<br>5-SIGNAL LIGHT<br>6-FLASHING RED LIGHT<br>7-FLASHING YELLOW LIGHT<br>8-STOP SIGN<br>9-YIELD SIGN<br>10-WARNING SIGN<br>11-CENTER STRIPED/DIVIDER<br>12-NO PASSING ZONE<br>13-RR GATE/SIGNAL<br>14-SCHOOL ZONE<br>15-CROSSWALK<br>16-BIKE LANE<br>17-OTHER | <table border="1" style="width:100%; height:100%;"> <tr><td style="font-size: 2em; font-weight: bold;">11</td></tr> </table>  | 11   | <b>ROADWAY RELATION</b><br>1-ON ROADWAY<br>2-OFF ROADWAY<br>3-SHOULDER<br>4-MEDIAN |
| 11   |   |  |  |
| <b>PART OF ROADWAY</b><br>1-MAIN LANE<br>2-SERVICE ROAD<br>3-ENTRANCE RAMP<br>4-EXIT RAMP<br>5-CORRECTOR<br>6-DETUR<br>7-OTHER   | <b>ROADWAY ALIGNMENT</b><br>1-STRAIGHT LEVEL<br>2-STRAIGHT GRADE<br>3-STRAIGHT HILLCREST<br>4-CURVE LEVEL<br>5-CURVE GRADE<br>6-CURVE HILLCREST<br>7-OTHER<br>8-UNKNOWN | <b>LIGHT CONDITION</b><br>1-DAYLIGHT<br>2-DARK, NOT LIGHTED<br>3-DARK, LIGHTED<br>4-DARK, UNK. LIGHTED<br>5-DAWN<br>6-DUSK<br>7-OTHER<br>8-UNKNOWN |  |
| <b>TYPE OF ROAD SURFACE</b><br>1-CONCRETE<br>2-BLACKTOP<br>3-BROCK<br>4-GRAVEL<br>5-DIRT<br>6-OTHER<br>7-UNKNOWN   | <b>WEATHER</b><br>1-CLEAR/LOUDY<br>2-RAIN<br>3-SLEET/HAIL<br>4-SNOW<br>5-FOG<br>6-BLOWING SAND/SNOW<br>7-SEVERE CROSSWINDS<br>8-OTHER<br>9-UNKNOWN                      | <b>SURFACE CONDITION</b><br>1-DRY<br>2-WET<br>3-STANDING WATER<br>4-SMOW<br>5-SLUSH<br>6-ICE<br>7-SAND/MUD/DIRT<br>8-OTHER<br>9-UNKNOWN            |  |



# Commercial Motor Vehicle Enforcement Supplement to the Texas Peace Officer's Crash Report

Questions? Call: 512/486-5780

10,001 LBS OR MORE  HAZARDOUS MATERIAL  9 OR MORE PASSENGER CAPACITY (DRIVER INCLUDED)

### CRASH INFORMATION

1. COUNTY TARRANT 2. CITY OR TOWN FORT WORTH  
3. ROAD ON WHICH CRASH OCCURRED 2350 NE LOOP 820  
BLOCK # STREET OR ROAD NAME ROUTE #  
4. DATE OF CRASH 07/10/2009 5. HOUR 5:35  AM  PM

LOC # 09-076903  
ORI # \_\_\_\_\_  
TxDOT # \_\_\_\_\_  
ROADWAY ACCESS  
 1-FULL ACCESS CONTROL  
 2-PARTIAL ACCESS CONTROL  
 3-NO ACCESS CONTROL

### DRIVER INFORMATION

6. NAME WARE, RONNIE 7. DRIVER'S LICENSE CLASS  2

1-A 4-M 7-BM  
2-B 5-UNK 8-CM  
3-C 6-AM

### CARRIER INFORMATION

8. VEHICLE OPERATION  INTERSTATE COMMERCE  INTRASTATE COMMERCE  NOT IN COMMERCE  GOVERNMENT  PERSONAL  
9. CARRIER'S CORPORATE NAME FORT WORTH TRANSIT AUTHORITY  
10. CARRIER'S PRIMARY ADDRESS 1600 E LANCASTER FT WORTH TX 76102  
NUMBER STREET CITY STATE ZIP  
11. CARRIER ID TYPE  ICC  US DOT  TxDOT  OTHER  NONE 12. CARRIER ID NUMBER \_\_\_\_\_

### MOTOR VEHICLE INFORMATION

13. UNIT NUMBER ON CR-3  1 14. LICENSE PLATE EXM TX 869182 15. GROSS VEHICLE WEIGHT RATING (GVWR)   
YEAR STATE NUMBER REGISTERED GROSS VEHICLE WEIGHT (RGVW)  26000

### 16. VEHICLE TYPE

3 1-PASSENGER CAR (ONLY IF VEHICLE DISPLAYS HM PLACARDS) 7-TRUCK TRAILER  
2-LIGHT TRUCK (ONLY IF VEHICLE DISPLAYS HM PLACARDS) 8-TRUCK TRACTOR (BOB TAIL)  
3-BUS (SEATS FOR 9-15 PEOPLE, INCLUDING DRIVER) 9-TRACTOR/SEMITRAILER  
4-BUS (SEATS FOR > 15 PEOPLE, INCLUDING DRIVER) 10-TRACTOR/DOUBLE TRAILER  
5-SINGLE UNIT TRUCK (2 AXLES, 6 TIRES) 11-TRACTOR/TRIPLE TRAILER  
6-SINGLE UNIT TRUCK (3 OR MORE AXLES) 99-UNKNOWN HEAVY TRUCK OVER 10,000 LBS (CANNOT CLASSIFY)

### 17. CARGO BODY STYLE

1 1-BUS (SEATS FOR 9-15 PEOPLE, INCLUDING DRIVER) 7-CONCRETE MIXER 98-OTHER \_\_\_\_\_  
2-BUS (SEATS FOR > 15 PEOPLE, INCLUDING DRIVER) 8-AUTO TRANSPORTER  
3-VAN/ENCLOSED BOX 9-GARBAGE/REFUSE  
4-CARGO TANK 10-GRAIN, CHIPS, GRAVEL  
5-FLATBED 11-POLE  
6-DUMP 12-NOT APPLICABLE

### 18. HAZARDOUS MATERIAL

TRANSPORTING PLACARDABLE HAZARDOUS MATERIAL  YES  NO HAZARDOUS MATERIALS RELEASED OR SPILLED  YES  NO (DO NOT INCLUDE FUEL FROM THE VEHICLE FUEL TANK)  
1 DIGIT CLASS #  4 DIGIT ID #  1 DIGIT CLASS #  4 DIGIT ID #

### TRAILER NUMBER 1 INFORMATION

19. LICENSE PLATE \_\_\_\_\_ 20. GROSS VEHICLE WEIGHT RATING (GVWR)   
YEAR STATE NUMBER REGISTERED GROSS VEHICLE WEIGHT (RGVW)  \_\_\_\_\_  
TRAILER TYPE  1-FULL TRAILER  
 2-SEMI TRAILER  
 3-POLE TRAILER

### TRAILER NUMBER 2 INFORMATION

21. LICENSE PLATE \_\_\_\_\_ 22. GROSS VEHICLE WEIGHT RATING (GVWR)   
YEAR STATE NUMBER REGISTERED GROSS VEHICLE WEIGHT (RGVW)  \_\_\_\_\_  
TRAILER TYPE  1-FULL TRAILER  
 2-SEMI TRAILER  
 3-POLE TRAILER

### 23. SEQUENCE OF EVENTS - UNIT 1

SEQ 1 SEQ 2 SEQ 3 SEQ 4  
 13     
1-NONCOLLISION RAN OFF ROAD  
2-NONCOLLISION JACKKNIFE  
3-NONCOLLISION OVERTURN (ROLLOVER)  
4-NONCOLLISION DOWNHILL RUNAWAY  
5-NONCOLLISION CARGO LOSS OR SHIFT  
6-NONCOLLISION EXPLOSION OR FIRE  
7-NONCOLLISION SEPARATION OF UNITS  
8-NONCOLLISION CROSS MEDIAN/CENTERLINE  
9-NONCOLLISION EQUIPMENT FAILURE  
10-NONCOLLISION OTHER  
11-NONCOLLISION UNKNOWN

12-COLLISION INVOLVING PEDESTRIAN  
13-COLLISION INVOLVING MOTOR VEHICLE IN TRANSPORT  
14-COLLISION INVOLVING PARKED MOTOR VEHICLE  
15-COLLISION INVOLVING TRAIN  
16-COLLISION INVOLVING PEDALCYCLE  
17-COLLISION INVOLVING ANIMAL  
18-COLLISION INVOLVING FIXED OBJECT  
19-COLLISION WITH WORK ZONE MAINTENANCE EQUIPMENT  
20-COLLISION WITH OTHER MOVABLE OBJECT  
21-COLLISION WITH UNKNOWN MOVABLE OBJECT  
98-OTHER \_\_\_\_\_

24. TOTAL NUMBER OF AXLES  2  
25. TOTAL NUMBER OF TIRES  4

26. OFFICER'S PRINTED NAME DETECTIVE TDP DAVIS 1965 DEPT. FT WORTH PD DATE 07/11/2009

## GENERAL

A separate commercial supplement is to be completed on **each** commercial motor vehicle involved in a motor vehicle crash. This supplement(s) must be attached to the basic peace officer's crash report. A commercial motor vehicle for supplemental reporting is defined as:

1. Any motor vehicle or towed vehicle with a Gross Vehicle Weight Rating (GVWR) or a Registered Gross Vehicle Weight (RGVW), whichever is greater, of 10,001 lbs. or more, or any combination of vehicles where the Gross Combined Weight Rating (GCWR) or the total RGVW of the combination is 10,001 lbs. or more.
  - 1.1 GVWR and RGVW are both defined as the weight of the fully equipped vehicle plus its net carrying capacity. The GCWR is the combined weight rating of a motor vehicle and a towed unit(s). On occasion, the GVWR and the RGVW will differ. In those situations, the greater weight value will be used to determine if this form must be completed.
  - 1.2 The GVWR of a motor vehicle normally can be found on an information plate on the driver's door or door post. The GVWR of a trailer normally can be found on an information plate near the front left portion of the trailer. If the vehicle does not have an information plate or it is illegible, use RGVW. For combination or token trailers, see 1.6 below.
  - 1.3 On vehicles registered in Texas, the RGVW is shown on the registration receipt under "gross weight." Commercial motor vehicles are required to carry the registration receipt.
  - 1.4 In the event the registration receipt is not available, RGVW can normally be obtained by a **complete** registration check. Exception: If the vehicle has exempt license plates (i.e. owned by a government entity) no RGVW will be shown. In those instances, GVWR must be used.
  - 1.5 If GVWR is used to determine the need to complete this supplement, GVWR for the motor vehicle and each trailer(s) must be obtained and shown in the appropriate blank(s).
  - 1.6 If RGVW is used to determine the need to complete this supplement, the RGVW should be obtained for each motor vehicle and trailer in the combination unless the combination is registered as a **combination/token** vehicle or as an **apportioned** vehicle. In those situations the license plates will indicate combination/token or apportioned. If the vehicle is registered as a combination/token or apportioned vehicle, the entire registered gross weight will be shown on the power unit and the trailer will not carry a RGVW. In those instances, show the RGVW of the combination in the power unit and show zero (0) on the trailer(s).
  - 1.7 RGVW for out-of-state vehicles and trailer(s) may be obtained from registration receipts issued by the licensing state, temporary permits, cab cards or other documents or as in 1.4 above.
2. Any bus, which shall include every motor vehicle with a seating capacity of nine (9) or more passengers (**including the driver**) and used for the transportation of persons. The seating capacity of a bus (excluding school buses) shall be determined by allowing one (1) passenger for each sixteen (16) inches of seat space. The seating capacity of a school bus shall be determined by allowing one (1) passenger for each thirteen (13) inches of seat space.
3. Any motor vehicle hauling hazardous materials which is required to be placarded under the Hazardous Materials Transportation Act.

## INSTRUCTIONS FOR COMPLETION OF FORM CR-3C

Detailed instructions for completion of this supplement are included in the Instructions to Police for Reporting Crashes.

### Check Boxes (Top of Report)

Check appropriate box indicating if the vehicle was over 10,001 pounds, Hazardous Material(s), or 9 or more passenger capacity (driver included). More than one box may be checked.

**Roadway Access** - Code the access control characteristics which best describes the roadway which the vehicle was traveling on at the time of the crash. Full Access Control is an expressway or freeway where the only means of entry to or exit from the roadway is by ramps connecting to other streets or highways. No Access Control is a street or highway where driveways provide access to and egress from adjacent properties and where cross streets intersect at a grade. Partial Access Control is a street or highway which does not clearly fit the above definitions.

### CRASH INFORMATION (Items 1-5)

Complete the information in this section exactly as shown on the basic report (CR-3).

### DRIVER INFORMATION (Items 6-7)

Complete items 6 and 7 exactly as shown on the basic report (CR-3).

### CARRIER INFORMATION (Items 8-12)

Indicate whether the operation of the commercial motor vehicle at the time of this crash is defined as an interstate, intrastate, government or personal operation. An interstate operation is one where the transportation of the property originated in one state or country and passed through or terminated in another state or country. An intrastate operation is one where the transportation of the property did not cross a state or international boundary. The bill of lading origin and destination information may be one source available to make this determination. Government and Personal use will be determined through investigation. Indicate the Carrier's corporate name and primary business address in items 9 and 10. The Carrier is defined as the entity responsible for the operation of the vehicle at the time of the crash. This may be the actual owner of the vehicle or the lessee. The information should match Owner/Lessee shown on the CR-3. Show the type of carrier identification by checking the appropriate box in item 11. Show the ID number in item 12, if applicable.

### MOTOR VEHICLE INFORMATION (Items 13-18)

Enter the unit number from the CR-3 for this motor vehicle in item 13. Show the registration year, state and number in item 14. Enter the GVWR and RGVW as applicable in item 15. Indicate which, GVWR or RGVW, by checking the appropriate box.

Indicate the appropriate number in the box for Vehicle Type in item 16.

Indicate the appropriate number in the box for Cargo Body Style in item 17.

Indicate by checking the appropriate box in item 18 whether this vehicle is hauling hazardous material(s). If yes, enter the class and ID numbers of the hazardous material(s) being transported. Indicate by checking the appropriate box whether hazardous materials were released (spilled, discharged, etc.) The class and ID numbers should be obtained from the bill of lading or shipping papers. If unavailable, the class and ID numbers may be taken from the placard. The class may be located in the lower corner of the diamond shaped placard. The ID numbers may be located on the placard or on an orange label near the placard. (REFER TO DETAILED INSTRUCTIONS.)

### TRAILER NUMBER 1 & 2 INFORMATION (Item 19-22)

If the commercial motor vehicle reported on this supplement is towing one trailer, complete trailer number 1 section only. If towing 2 trailers, complete both trailer number 1 and 2 sections.

Indicate the registration year, state, and number in item 19, and if applicable item 21. Show the GVWR or RGVW in item 20 and, if applicable, item 22.

Indicate which, GVWR or RGVW by checking the appropriate box.

Indicate the appropriate number in the box for Trailer Type (item 20, and if applicable, item 22).

**Indicate Sequence of Events (Item 23).** Indicate the order and type of crash events which occurred involving this vehicle.

**Indicate the Total Number of Axles (Item 24).** Indicate the total number of axles on the motor vehicle.

**Indicate the Total Number of Tires (Item 25).** Indicate the total number of tires on the motor vehicle.

**The person completing this supplement should print name, show department and the date this supplement was prepared in item 26.**

Case No.:

09076903

Address 1:

2350 NE Loop 820 E/B

County:

Tarrant



5300 Mark IV Parkway

2350 NE Loop 820  
East Bound  
Lanes Only

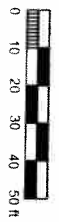
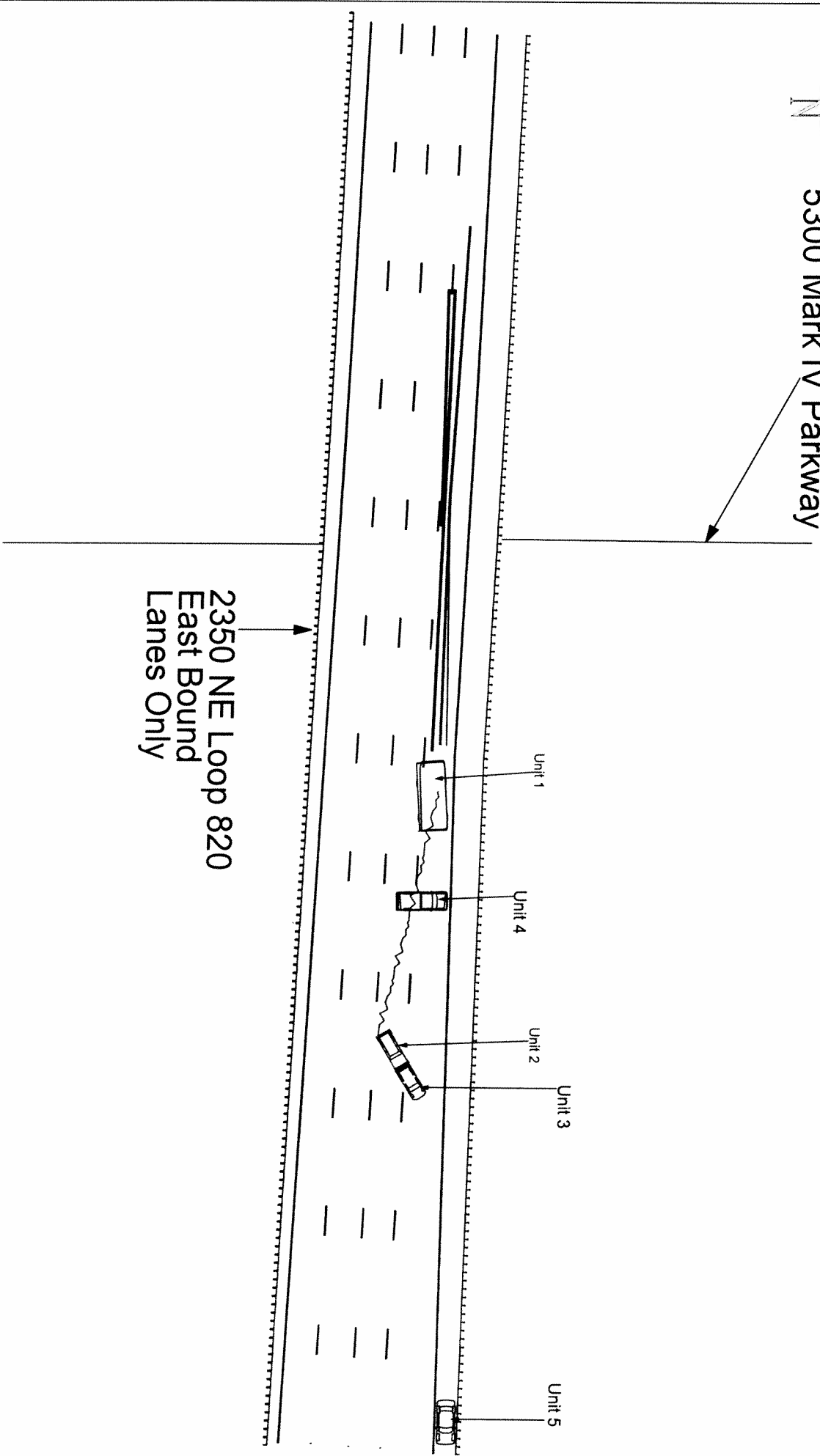

Officer:

Detective TDP Davis 1965

FWPD

Date:

071009

Time:

5:35 pm

**Attachment H**  
**Letter to Senator Richard Durbin from Chrysler**



**CHRYSLER**

August 27, 2009

John T Bozzella

The Honorable Richard Durbin  
United States Senate  
Washington, DC 20510

Dear Senator Durbin:

We very much appreciate the support you have given to the new Chrysler Group LLC, and we understand the concerns you have raised about Chrysler Group's commitments on product liability claims.

As you know, on June 10, 2009, Chrysler Group purchased substantially all of the assets of the former Chrysler LLC (now known as "Old Carco LLC"). As part of the bankruptcy court-approved sale transaction, Chrysler Group assumed product liability claims relating solely to vehicles sold by Chrysler Group to its dealers. Chrysler Group did not assume product liability claims arising out of vehicles sold before June 10, 2009 (except to the extent required by our sales and service agreements with sustained dealers).

Today, Chrysler Group has a much better appreciation of the viability of our business than it did on June 10. As a result, we will announce today that the company will accept product liability claims on vehicles manufactured by Old Carco before June 10 that are involved in accidents on or after that date. This is in addition to our previous commitment to honor warranty claims, lemon law claims and safety recalls regarding these vehicles. As a result of today's announcement, Chrysler Group's approach is consistent with that taken by General Motors as part of its bankruptcy process.

While Chrysler Group still faces challenges, we are confident today that the future viability of the company will not be threatened if we assume these obligations. We want our customers to feel comfortable and confident buying, driving and enjoying one of our vehicles. Chrysler Group vehicles meet or exceed all applicable federal safety standards and have excellent safety records.

We appreciate your dedication to exploring this issue with us through hearings and conversations with our key executives. We hope this decision alleviates your concerns and assures you that we stand behind our products, our customers and our dealers.

Sincerely,

A handwritten signature in black ink, appearing to read "John T. Bozzella", is located below the "Sincerely," text.

Cc: Chairman Patrick Leahy  
Senator Arlen Specter  
Senator Herb Kohl



# Tab 3

Paul V. Sheridan letter to Center for Auto Safety of June 1, 2010

-----  
Paul V. Sheridan letter of 13 February 2012 to Congressmen:

Representative Elijah Cummings  
Representative James D. Jordan  
Representative Mike Kelly  
Representative Dennis Kucinich

Subject: 1993-2004 Jeep Grand Cherokee Post-Collision Fire Death Defect Investigation  
Reference: House Oversight and Government Reform Hearing (Chevrolet Volt) of 25Jan2012



FedEx Express  
Customer Support Trace  
3875 Airways Boulevard  
Module H, 4th Floor  
Memphis, TN 38116

U.S. Mail: PO Box 727  
Memphis, TN 38194-4643  
Telephone: 901-369-3600

June 4, 2010

Dear Customer:

The following is the proof-of-delivery for tracking number **869667283713**.

---

**Delivery Information:**

|                       |              |                           |                                   |
|-----------------------|--------------|---------------------------|-----------------------------------|
| <b>Status:</b>        | Delivered    | <b>Delivery location:</b> | 1200 N.J. AVE SE W41 306<br>20590 |
| <b>Signed for by:</b> | T.MAPP       | <b>Delivery date:</b>     | Jun 4, 2010 13:15                 |
| <b>Service type:</b>  | Standard Box |                           |                                   |

---

**Shipping Information:**

|                         |              |                   |                |
|-------------------------|--------------|-------------------|----------------|
| <b>Tracking number:</b> | 869667283713 | <b>Ship date:</b> | Jun 3, 2010    |
|                         |              | <b>Weight:</b>    | 2.0 lbs/0.9 kg |

**Recipient:**  
DAVID STRICKLAND  
NHTSA-WEST BLDG  
1200 NEW JERSEY SE  
20590 US

**Shipper:**  
PAUL SHERIDAN  
SHERIDAN, PAUL V  
22357 COLUMBIA ST  
481243431 US

**Reference**

KLINE

Thank you for choosing FedEx Express.

FedEx Worldwide Customer Service  
1.800.GoFedEx 1.800.463.3339

To: Mr. Clarence Ditlow, Director \*  
Center for Auto Safety  
Suite 330  
1825 Connecticut Ave, NW  
Washington, DC 20009-5708  
(202) 328-7700

Date: 1 June 2010

VIA EMAIL AND FEDEX 1283181-00003186

From: Mr. Paul V. Sheridan  
DDM Consultants  
22357 Columbia Street  
Dearborn, MI 48124-3431  
313-277-5095 / [pvs6@Cornell.edu](mailto:pvs6@Cornell.edu)

**Subject 1: Jeep Grand Cherokee Defect Petition 09-005 (DP-09-005) File Update**

**Subject 2: Has Chrysler Group LLC Declared the Bankruptcy Order Void?**

### Courtesy Copy List

Ms. Angel M. DeFilippo  
Grieco Oates & DeFilippo, LLC  
414 Eagle Rock Avenue  
West Orange, NJ 07052  
973-243-2099

Mr. Courtney E. Morgan, Jr.  
Morgan & Meyers, PLLC / Suite 320  
3200 Greenfield Road  
Dearborn, MI 48120  
313-961-0130

Mr. David L. Strickland  
NHTSA Headquarters/West Building  
1200 New Jersey Avenue, SE  
Washington, DC 20590  
888-327-4236

Honorable Arthur J. Gonzalez, Chief Judge  
U.S. Bankruptcy Court for the  
Southern District of New York  
One Bowling Green  
New York, NY 10004-1408  
(212) 668-2870

Senator Frank Lautenberg  
324 Hart Senate Office Building  
District of Columbia 20510-3003  
202-224-3224

Senator Carl Levin  
269 Russell Senate Office Building  
Washington, D.C. 20510-2202  
202-224-6221

Ms. Silvia Gambardella  
Special Projects Producer- WTVD  
411 Liberty Street  
Durham, NC 27701  
919-687-2219

Mr. Brian S. Malone  
Publisher/Editor  
Times of Trenton  
500 Perry Street  
Trenton, N.J. 08605  
609-989-5665

\* Available with hyperlinks here: <http://links.veronicachapman.com/Ditlow-Baker-1.pdf>

DDM Consultants  
22357 Columbia Street  
Dearborn, MI 48124-3431  
313-277-5095  
[pvsheridan@comcast.net](mailto:pvsheridan@comcast.net)

1 June 2010

Mr. Clarence Ditlow, Director  
Center for Auto Safety - Suite 330  
1825 Connecticut Ave, NW  
Washington, DC 20009-5708  
(202) 328-7700

**Subject 1: Jeep Grand Cherokee Defect Petition 09-005 (DP-09-005) File Update**  
**Subject 2: Has Chrysler Group LLC Declared the Bankruptcy Order Void?**

Dear Mr. Ditlow:

### **Review**

Previously I had submitted DaimlerChrysler Safety Recall No. A10–Fuel Tank Blocker Bracket <sup>1</sup> as a [file update to the subject](#) (Attachment 1). What remains significant about this document is that it represents the first time that three key words were used connectedly and simultaneously with respect to the Jeep Grand Cherokee:

“safety”  
“skid plate”  
“repaired”

Although the underlying portent is well-understood internally to Chrysler and its dealers, Safety Recall A10 represented the first admission that Grand Cherokee fuel tank safety/crashworthiness issues could be “repaired” by existence or installation of a skid plate. Alternatively, I have not located MOPAR documentation or Chrysler new vehicle sales order guides that promote these three key words simultaneously. MOPAR materials use phraseology such as “recreation” when selling the fuel tank skid plate to the aftermarket. The new vehicle sales brochures/documents for option package “XEE” use similar descriptions. <sup>2</sup>

Again, prior to my discovery/submission of Safety Recall A10 to the lawsuit of Kline v. Chrysler, Lomans, et al., these three key words were never simultaneously offered to the public; either from Chrysler, from Chrysler dealerships, or from NHTSA (Attachment 1). <sup>3</sup>

---

<sup>1</sup> Dated February 2002, I was unable to locate Safety Recall A10 at the NHTSA website, and it was only recently that you located its cover letter of January 4, 2002 from Matthew Reynolds of the DaimlerChrysler Vehicle Compliance Office.

<sup>2</sup> Although refusing to be interviewed, Chrysler re-emphasized this public posturing/vernacular in their statement submitted to an [ABC News report](#) which described the death of Mrs. Susan Kline; [a case we reviewed pictorially in Attachment F of DP-09-005](#).

<sup>3</sup> As you will see below, Chrysler’s promotional use of the phrase ‘fuel tank skid plate’ is misleading since it implies a purpose restricted to mere recreation. In truth, the essential elements of fuel system crashworthiness are intrinsic to its purpose/design. Internally, for decades, and at the engineering level, it has been referred to as “*a protective impact deflection structure.*”

### **Subject 1: Jeep Grand Cherokee Defect Petition 09-005 (DP-09-005) File Update**

I recently re-acquired a document that was part of my Chrysler FMVSS-301 files (Attachment 2). This "CONFIDENTIAL" August 24, 1978 memo by Mr. Leonard Baker, former Safety Manager of Chrysler Engineering,<sup>4</sup> is entitled: Fuel System Design—Chrysler Passenger Car and Trucks. The subsection "Truck – Fuel Tank Location" states:

*"Chrysler is investigating fuel tank relocation ahead of the rear wheels for vans and multipurpose vehicles, but present plans for pickups through 1983 and for MPV's and vans through 1985 have the fuel tank located behind the rear wheels. In vehicles both with and without bumpers there is a concern with vertical height differences that create a mismatch with passenger car bumpers. Where fuel tank location behind the rear axle is all that is feasible, a protective impact deflection structure may have to be provided whether or not a bumper is provided. An investigation whether to relocate the fuel tank or to provide impact deflecting structures is presently underway."* (Attachment 3)

In stark contrast to an "on the surface" wording that was legally deployed in Safety Recall A10, this "Baker memo" of the former Chrysler Corporation (Old Carco) confirms detailed internal knowledge of the following fundamental fuel system defect/crashworthiness issues:

1. The fundamental lack of safety when fuel tanks are NOT located "*ahead of the rear wheels*" (such as in the Ford Pinto or the 1993-2004 Jeep Grand Cherokee).
2. The fundamental lack of safety when fuel tanks are located below the rear bumper, and are therefore vulnerable to the underride accident scenario due to "*a concern with vertical height differences that create a mismatch with passenger car bumpers*" (such as in the 1993-2004 Jeep Grand Cherokee).
3. The fundamental lack of safety when fuel tanks are unshielded; that is, when these have NOT been provided with "*a protective impact deflection structure*" (i.e. a fuel tank skid plate, which would have "repaired" the 1996 Jeep Grand Cherokee driven by Mrs. Kline).<sup>5</sup>

All three of these fuel system defect/crashworthiness issues were intrinsic to the accident sequence which occurred on February 24, 2007; [leading to the horrific death of New Jersey resident Mrs. Susan Kline](#). All three fuel system defect/crashworthiness issues were corrected in 2005 with the WK version of the Jeep Grand Cherokee; an engineering design which was heavily influenced by Daimler which has not had any fire related severe burn or death victims.<sup>6</sup>

<sup>4</sup> Mr. Baker later moved to an organization promoted as the Product Analysis Group. In-truth Product Analysis is part of the [Chrysler Legal department](#). In this later role, Baker reported to staff such as [Mr. Lewis Goldfarb](#) (Lead attorney for safety defect litigation) and [Mr. William O'Brien \(Chrysler Counsel\)](#); both of whom were involved in the confiscation of my Chrysler office safety files (Attachment 2). Attachment 3 was written to Mr. Robert M. Sinclair, who later became Executive VP of Chrysler Engineering, reporting to President Hal Sperlich and Chairman Lee Iacocca.

<sup>5</sup> Please see footnote 3, page one. It should be recognized that discussion of "*a protective impact deflection structure*" was occurring/extensive during a period when plastic fuel tanks were not yet in use at Chrysler.

<sup>6</sup> Option "XEE" is [not available on the 2005-2010 WK Jeep Grand Cherokee](#) since these versions are equipped with "*a protective impact deflection structure*" (i.e. a fuel tank skid plate) [as standard](#). This is also true for the [2011 WL version](#) which shares major development/part commonality with the [Mercedes-Benz ML Class SUV](#) (which has never included the three fuel system design defects described by Baker).

**Subject 2: Has Chrysler Group LLC Declared the Bankruptcy Order Void?**

I am sharing this "Confidential" Baker memo with no moral or ethical risk. However, public disclosure of related or similar documents may pose a legal risk.

On March 30, 2009 [President Obama announced the determination by his 'Auto Task Force'](#) that a taxpayer-funded bailout would require that Chrysler LLC (Old Carco) file for bankruptcy. The latter was granted by Judge Arthur Gonzalez of the U.S. Bankruptcy Court for the Southern District of New York on June 1, 2009. Since that ruling, billions of taxpayer dollars have been funneled to Chrysler Group LLC (New Carco), including a near-billion-dollar grant to Chrysler dealers. [In bankruptcy court filings Chrysler declared](#) that it will:

*"Only pay incentives to those dealers that they believe have value to the acquiring company."*

Respecting the President's knowledge of the bankruptcy laws, Chrysler continually emphasized distinctions between entities that possessed value versus those that did not. Old Carco, allegedly bankrupt circa June 1, 2009, was publicly and unequivocally declared as having no value. Indeed, minutes after the President's announcement, plaintiffs nationwide hurriedly received a facsimile entitled, "Notice of Suggestion of Bankruptcy" alleging this 'no value' status (Attachment 4).

However, [in the case of Kline v. Chrysler, Lomans, et al.](#), Chrysler Group LLC has ostensibly declared the bankruptcy status of Old Carco as void. In response to discovery (served on April 22, 2010 for production on May 7, 2010) Chrysler Group LLC has unabashedly reversed its earlier legal position regarding the 'no value' status of Old Carco by repeatedly resurrecting the following pre-bankruptcy rhetoric against plaintiffs:

*"Assuming an appropriate protective order is entered, Chrysler Group LLC will produce the documents by May 28, 2010. Almost all the (Old Carco) documents you are seeking contain confidential commercial information. As such, Chrysler Group LLC will not produce these (Old Carco) documents without a protective order in place. I will forward a proposed protective order to you with the discovery responses." (Attachment 5)*

In order to secure the billion-dollar taxpayer-funded bailout, Chrysler Group LLC was compelled to [liquidate the assets of Old Carco and declare it insolvent \(i.e. bankrupt\)](#). However, in the closed-door realm of safety defect litigation, Chrysler Group LLC is now proclaiming that this publicly promoted claim of liquidation/insolvency was merely a ruse; that in-reality Old Carco retains substantial value, and therefore the Baker memo and related or similar discovery documents which relate to an *"investigation presently underway"* are commercially proprietary, confidential, and valuable.

Respectfully yours,

[Paul V. Sheridan](#)



# Attachment 1

February 2002

Dealer Service Instructions for:

**Safety Recall No. A10 -- Fuel Tank Blocker Bracket**

Effective immediately, all repairs on involved vehicles are to be performed according to this recall notification. The labor operations for the interim service procedure that was published in the A10 electronic mail (DMAIL) message of January 4, 2002 will be cancelled on March 15, 2002. Those vehicles that have already been repaired by having a skid plate installed, do NOT require any additional service.

**Models****2002 (WJ) Jeep® Grand Cherokee**

*NOTE: This recall applies only to the above vehicles that are equipped with a fuel tank brush guard (WITHOUT Sales Code – XEE) built through December 13, 2001 (MDH 121317).*

**IMPORTANT:** Some of the involved vehicles may be in dealer new vehicle inventory. **Federal law requires you to stop sale and complete this recall service on these vehicles before retail delivery.** Dealers should also consider this requirement to apply to used vehicle inventory and should perform this recall on vehicles in for service. Involved vehicles can be determined by using the DIAL VIP System.

**Subject**

About 71,000 of the above vehicles may not comply with the requirements of Federal Motor Vehicle Safety Standard (FMVSS) 301 – Fuel System Integrity. Under certain accident conditions, the fuel tank may deform and damage an internal control valve. This could allow fuel leakage to occur if the vehicle rolls over. Fuel leakage in the presence of an ignition source can result in a fire.

**Repair**

A fuel tank blocker bracket must be installed on all involved vehicles.

**Parts Information**

| <u>Part Number</u> | <u>Description</u>               |
|--------------------|----------------------------------|
| <b>CBJ0A100</b>    | <b>Fuel Tank Blocker Bracket</b> |

**Each dealer** to whom vehicles in the recall were invoiced will receive enough Blocker Bracket Packages to service about **10%** of those vehicles. Each package contains a blocker bracket and a spacer.

**Service Procedure**

1. Raise the vehicle on an appropriate hoist.
2. Support the fuel tank with an OTC Fuel Tank Jack or equivalent.
3. Remove the four (4) fuel tank-to-rear bumper fascia clips (Figure 1).
4. Loosen, but do not remove, the bolts for the two (2) rear brush guard-to-frame support brackets (Figure 2).

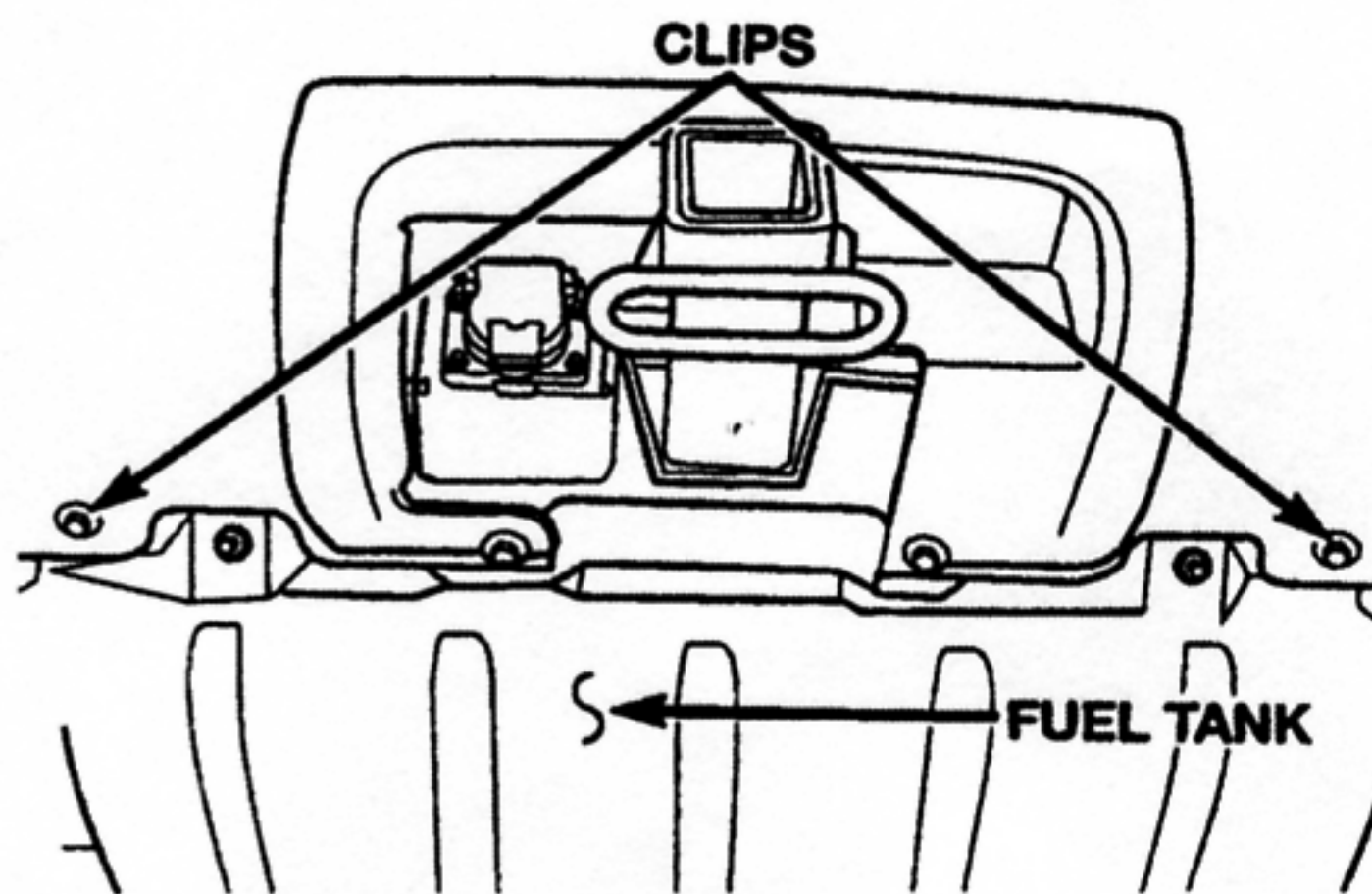

Figure 1

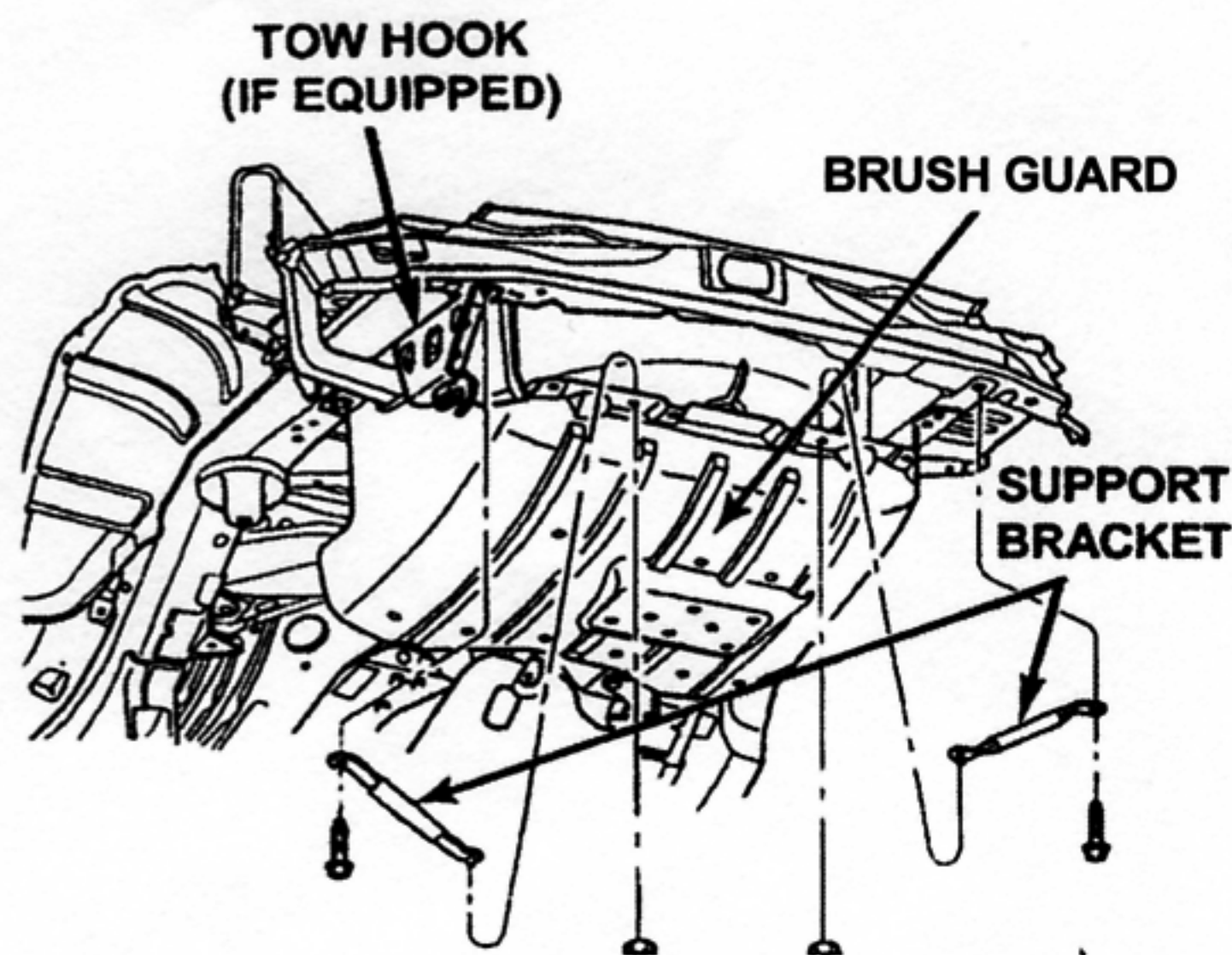

Figure 2



**Service Procedure (Continued)**

5. Loosen, but do not remove, the bolts for the front brush guard-to-frame support bracket (Figure 3).
6. Disconnect the electrical harness clip from the left side of the brush guard.

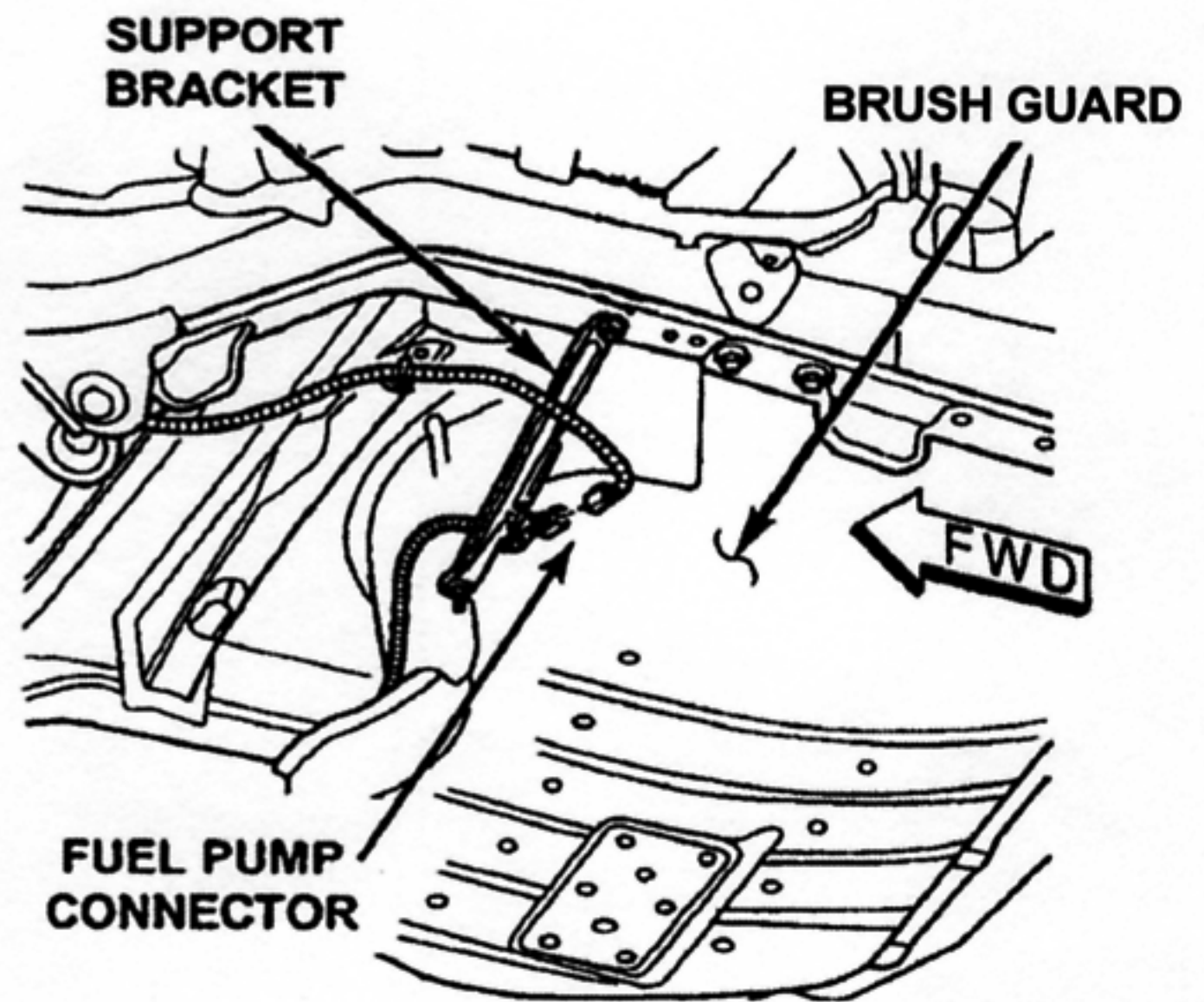

Figure 3

7. Remove the three (3) forward-most LEFT SIDE brush guard/trailer hitch (if equipped) mounting bolts (Figure 4). **DO NOT remove the rear left brush guard/trailer hitch mounting bolt.**
8. Loosen, but do not remove, the remaining four (4) brush guard bolts (one left side and three right side).
9. **For vehicles equipped with a trailer hitch,** loosen but do not remove, the two (2) rear-most trailer hitch bolts.
10. Using a large pry bar, reposition the fuel tank/brush guard assembly as far to the right side of the vehicle (passenger side) as possible.

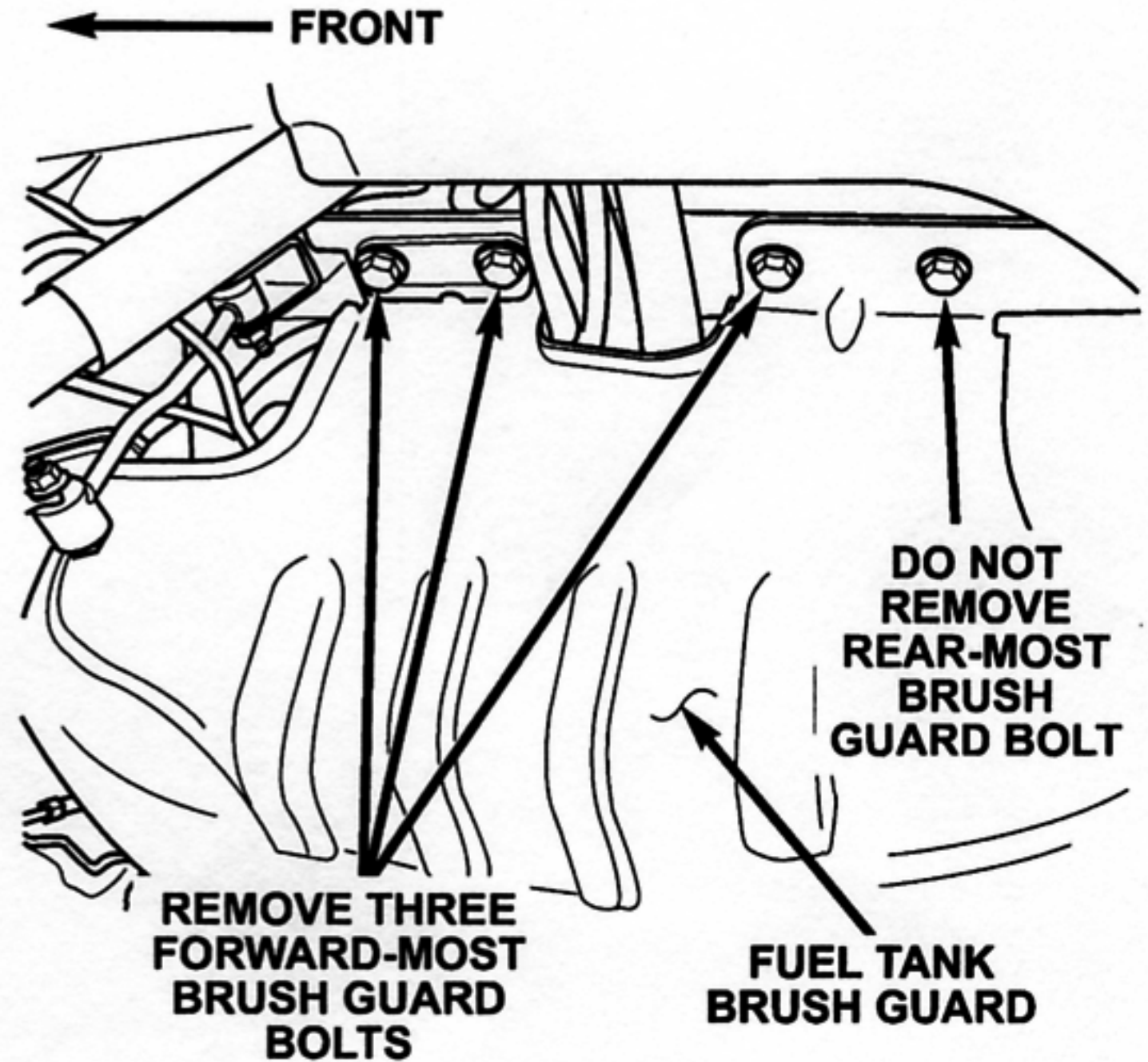

Figure 4



|                                      |
|--------------------------------------|
| <b>Service Procedure (Continued)</b> |
|--------------------------------------|

11. With an assistant holding the tank assembly in the right-most position, and using a 12 inch extension, tighten the three right and the rear-most left, brush guard bolts to 65 ft-lbs (88 N·m).
12. **For vehicles equipped with a trailer hitch,** tighten the two (2) rear-most trailer hitch bolts to 65 ft-lbs (88 N·m).
13. Install the fuel tank blocker bracket adjacent to the left side of the fuel tank brush guard (Figure 5).

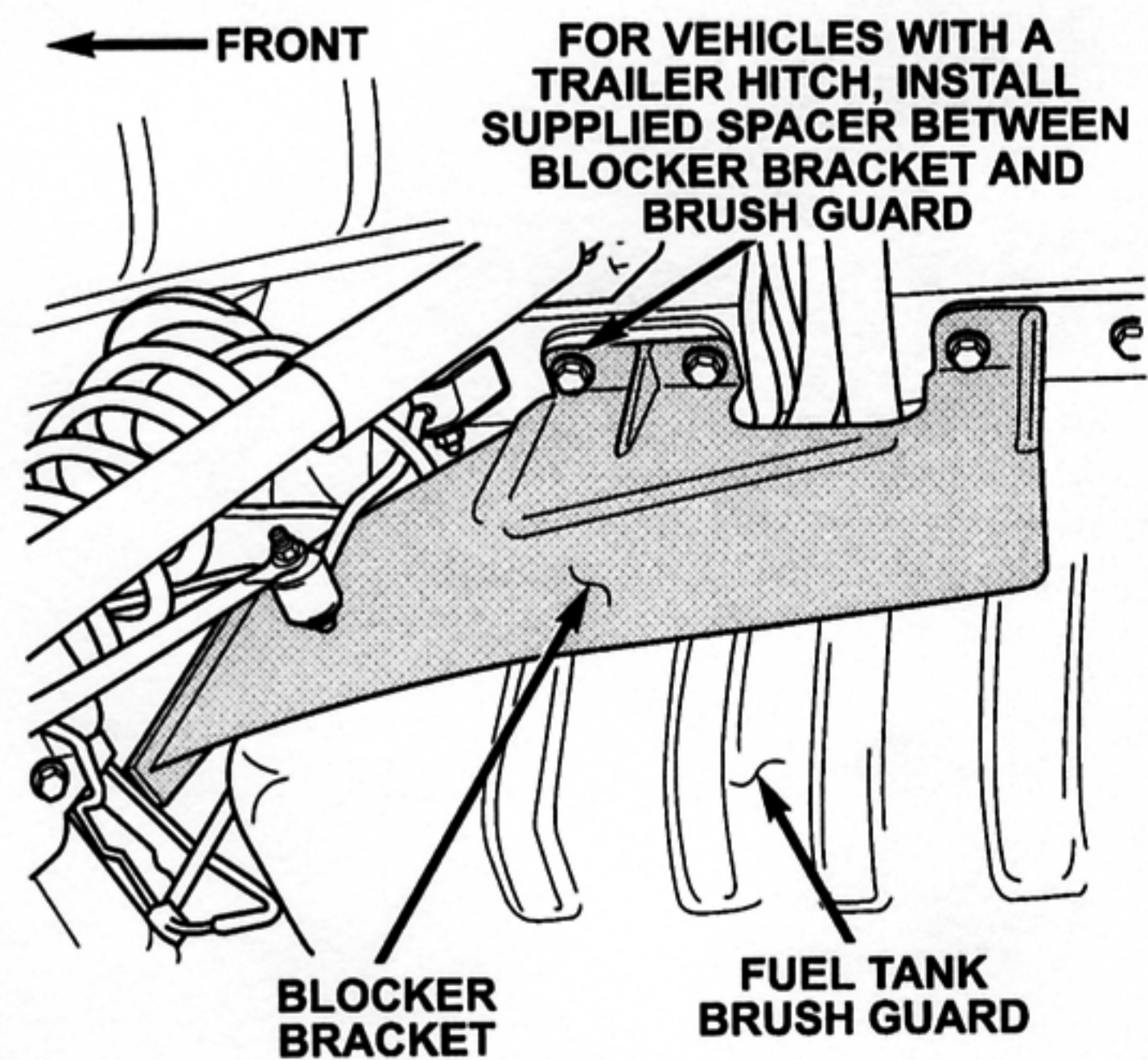

Figure 5

**IMPORTANT:** For vehicles equipped with a trailer hitch, install the supplied spacer between the blocker bracket and the brush guard at the forward-most bolt hole location.

14. Position the blocker bracket as far to the right as possible (next to the brush guard) and then install the fuel tank brush guard/trailer hitch mounting bolts (Figure 5). Using a 12 inch extension, tighten the bolts to 65 ft-lbs (88 N·m).

**IMPORTANT:** Tighten the forward-most blocker bracket bolt first.

15. Secure the electrical harness to the blocker bracket with the harness clip. If the clip was damaged during removal, use a new clip (PN 04688451).
16. Tighten the front brush guard-to-frame support bracket bolts (Figure 3).
17. Tighten the bolts for the two (2) rear brush guard-to frame support brackets (Figure 2).
18. Install the four (4) rear fascia-to-fuel tank push pins (Figure 1).
19. Remove the fuel tank support.
20. Lower the vehicle.

**Completion Reporting and Reimbursement**

Claims for vehicles that have been serviced must be submitted on the DIAL System. Claims submitted will be used by DaimlerChrysler to record recall service completions and provide dealer payments.

Use the following labor operation number and time allowance:

|                                   | <b>Labor Operation<br/>Number</b> | <b>Time<br/>Allowance</b> |
|-----------------------------------|-----------------------------------|---------------------------|
| Install Fuel Tank Blocker Bracket | 14-A1-01-84                       | 0.3 hours                 |

Add the cost of the recall parts package plus applicable dealer allowance to your claim.

NOTE: See the Warranty Administration Manual, Recall Claim Processing Section, for complete recall claim processing instructions.

**Parts Return**

Not applicable.

**Dealer Notification and Vehicle List**

All dealers will receive a copy of this dealer recall notification letter by first class mail. Two additional copies will be sent through the DCMMS, and the MDS2 will be updated to include this recall in the near future. **Each dealer to whom involved vehicles were invoiced will receive a list of their involved vehicles.** The vehicle list is arranged in Vehicle Identification Number (VIN) sequence. Owners known to DaimlerChrysler are also listed. The lists are for dealer reference in arranging for service of involved vehicles.



### **DIAL System Functions 53 and VIP**

All involved vehicles have been entered to DIAL System Functions 53 and VIP for dealer inquiry as needed.

Function 53 provides involved dealers with an updated VIN list of their incomplete vehicles. The customer name, address and phone number are listed if known. Completed vehicles are removed from Function 53 within several days of repair claim submission. To use this system, type "53" at the "ENTER FUNCTION" prompt, then type "ORDA10".

### **Owner Notification and Service Scheduling**

All involved vehicle owners known to DaimlerChrysler are being notified of the service requirement by first class mail. They are requested to schedule appointments for this service with their dealers. A copy of the owner letter is attached.

Enclosed with each owner letter is an Owner Notification Form. The involved vehicle and recall are identified on the form for owner or dealer reference as needed.

### **Vehicle Not Available**

If a vehicle is not available for service, let us know by filling out the pre-addressed Owner Notification Form or describe the reason on a postcard and mail to:

DaimlerChrysler Corporation  
CIMS 482-00-85  
800 Chrysler Drive East  
Auburn Hills, Michigan 48326-2757

### **Additional Information**

If you have any questions or need assistance in completing this action, please contact your Zone Service Office.

Customer Services Field Operations  
DaimlerChrysler Corporation

## **Attachment 2**

LAW OFFICES  
**CHAMBERS STEINER**

A Professional Corporation

1490 FIRST NATIONAL BUILDING  
DETROIT, MICHIGAN 48226-3592

Telephone (313) 961-0130  
Fax (313) 961-8178

JOHN F. CHAMBERS  
SANFORD L. STEINER  
MICHAEL S. MAZUR  
ALEXANDER T. ORNSTEIN  
DARRELL M. AMLIN  
COURTNEY E. MORGAN  
JEFFREY T. MEYERS  
ANGELA J. NICITA  
LOUIS G. COREY  
JOHN I. KITTEL  
RICHARD J. CAROLAN  
MICHELLE J. HARRISON  
PATRICIA A. MURRAY  
CHRISTOPHER S. HARTMAN  
FRANKLIN J. CHAMBERS  
MARTIN R. STURM  
KEVIN P. BURCH  
DOUGLAS A. MERROW  
LISA A. KLAEREN  
FRANK B. MELCHIORE  
DANIEL C. BROWN

**KALAMAZOO OFFICE**  
7040 STADIUM DRIVE  
KALAMAZOO, MICHIGAN 49009  
Telephone (616) 375-4300  
Fax (616) 375-4077

**ROSEVILLE OFFICE**  
25235 GRATIOT AVE.  
ROSEVILLE, MICHIGAN 48066  
(810) 773-3455

July 14, 1995

Thomas G. Kienbaum, Esq.  
500 Woodward Ave., Suite 4000  
Detroit, Michigan 48226-3406

Re: Chrysler vs. Sheridan

Dear Mr. Kienbaum:

I am in receipt of your most recent correspondence regarding the magistrate's recommendation and our providing of information to you regarding office materials. I do not know how you could have reasonably concluded from the correspondence that was forwarded to you that we are of the opinion that there is no basis to conclude that evidence may have been tampered with in this case. Indeed, the anxiety exhibited by the fact that you immediately faxed your reply to me suggests that in reality you hold the opposite opinion. Due to the necessity of my attendance at federal court in Wichita, Kansas this week, I did not believe that I was going to be able to comply with the July 14, 1995 deadline. Now, it appears that we are in a position to comply.

The information provided hereunder is based upon our limited and restricted ability to review materials which were allegedly seized from Mr. Sheridan's work space. That review is neither complete, nor did it have as its purpose the ferreting out of all details of evidence tampering which may exist. Lack of inclusion of any specific item in this list shall not be taken as an admission of the authenticity of such a document or other tangible item.

The document submitted by the plaintiff entitled, "Confidential Inventory of Material from Paul V. Sheridan's Cubicle at the Chrysler Technology Center", dated March 16, 1995, has numerous general inconsistencies and inaccuracies based on defendant's knowledge and cursory examination of the actual inventory:



July 14, 1995

1. This "inventory" fails to list and does not contain the following files:

- Liftgate Latch - General
- Liftgate Latch - Competitive
- Safety Leadership Team - Meeting Minutes
- Safety Leadership Team - Preliminary
- Liftgate Latch - Safety Office
- H. G. Cook Study
- FMVSS 206 - General
- Seat Back Strength - General
- Seat Back Strength - FMVSS 207 Specifications
- Offset Impact - General
- Rear Crash Survivability - General
- FMVSS - 301
- Side Crashworthiness Issues
- FMVSS - 214
- Bumper Issues - General
- NS-Body Bumper
- Taillamp Studies - Zarowitz
- Amber Taillamp - NS-Body
- Rear Seat Headrest - General and Zarowitz
- Back-up Light - General

2. The "inventory" lists files but inaccurately portrays their original/current contents:

- Box #1 - File "NS Liftgate System". This file contained subfiles such as "Customer Injury", "Saginaw", et al. Also contains photographs that were originally in the "Liftgate Latch - General" file which is missing per #1 above. (see page 4 of inventory).

CHAMBERS STEINER

Page 3

July 14, 1995

- Box #1 - File "NHTSA News" contains only half its original contents (see page 4 of inventory).
- Box #1 - File on "Muth Technologies" not listed; subfile "RSZ" not listed (see page 4).
- Entry on page 8 of inventory indicates that a file contained "correspondence for Dr. Detroit Motorsports". No correspondence was ever sent to Mr. Sheridan's Chrysler office for Dr. Detroit Motorsports, nor was any on file at that location.

3. The "inventory" identifies files and file locations by box number but the location identified was found to be inaccurate.

4. The "inventory" fails to explain/list file materials that were found in the actual inventory by defendant:

- Documents relating to FMVSS-208 dated December 21 were found in Box #1 in file "NS-Restraints". This file is not listed on inventory. (see page 4)

5. This "inventory" fails to accurately explain/list documents allegedly found in the cubicle, as described during the deposition of plaintiff's investigators.

6. The "inventory" fails to list files that were found in the actual inventory.

7. The "inventory" fails to list/identify location of specific video tapes:

- Environmentally Safe Oil Changes
- Formula SAE
- IIHS Bumper Tests
- Etc.



CHAMBERS STEINER

Page 4

July 14, 1995

8. The "inventory" fails to accurately list contents of computer disks and computer hard drive.

This response is not complete. Further examinations of inventory is still pending. Preliminary examinations cover documents listed through page 18, but not Box #7. Document listings from page 18 through 39 have not yet been examined.

Sincerely,

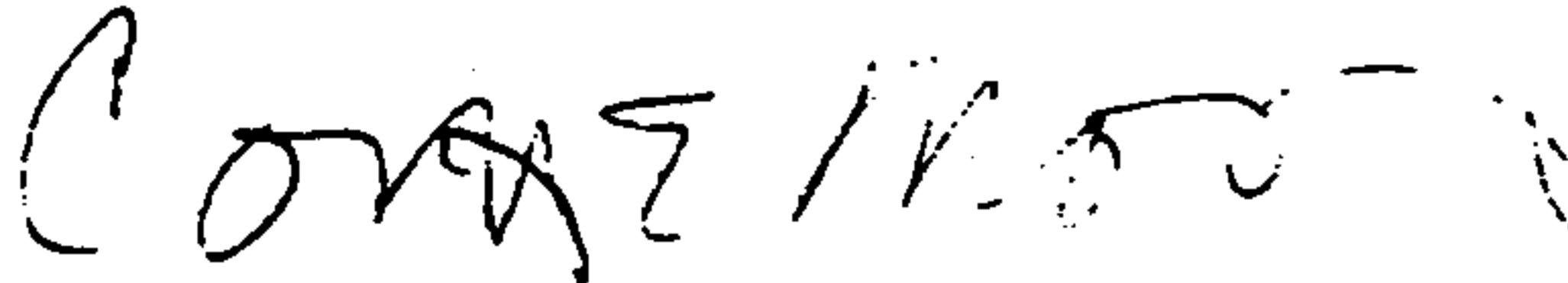

Courtney E. Morgan, Jr.

CEM/mn

cc: George Googasian, Esq.  
(Via Facsimile)

## **Attachment 3**

Inter Company Correspondence

File Code

Date

August 24, 1978

| Name & Department   | Division                         | Plant/Office       | CIMS Number |
|---|----------------------------------|--------------------|-------------|
| R. M. Sinclair, Director<br>International Product Development | Product Plan.<br>& Design Office | Chrysler<br>Center | 416-20-15   |
| L. L. Baker, Manager<br>Automotive Safety                     | Engineering<br>Office            | Chrysler<br>Center | 418-12-34   |

Subject: Fuel System Design - Chrysler Passenger Cars And Trucks.

Pursuant to the discussions between Messrs. Vining, Jeffe, Sperlich and yourself with Mr. Mochida on August 22, the fuel system design for domestic passenger cars and trucks is summarized for Mr. Mochida's information.

Not only are the impact performance requirements of MVSS-301 pertinent to the design approach but the significant increase in the last few years in the numbers of product liability cases involving fuel system fires and the increase in the size of the awards by sympathetic juries has to be recognized. In the Ford Pinto case the NHTSA Office of Defects Investigation selected arbitrary performance criteria of minimal or no fuel leakage when the test car is impacted in the rear by a full size car at 35 mph as a basis for questioning the safety of a recall modification of the Pinto.

• Passenger Car

Fuel Tank Location

The front wheel drive configuration in Chrysler's Omni and Horizon allowed the fuel tank to be located beneath the rear seat. This location provides the protection of all of the structure behind the rear wheels--as well as the rear wheels themselves--to protect the tank from being damaged in a collision. This same location will be used in the new 1981 K-Body cars which will also have a front wheel drive.

The rear wheel drive H-Body scheduled for introduction in 1983 will have the fuel tank located over the rear axle and beneath the floor pan.

The question of whether M, R or J-Body cars should be converted to tank over axle prior to their phase-out is a matter under intensive study at this time.

Filler Neck And Cap

As the fuel tank is moved to a more forward location, the fuel fill is moved to the side of the car. The fuel cap will be recessed below the body surface and a fuel fill door provided. The fuel filler neck is designed to break away from the car body with the fuel filler cap still in place.

In this design the filler cap and fill neck or fill tube remain with the tank to avoid separation and possible fuel leakage. This side fill is scheduled for J and M-Bodies in 1980 and the Y-car in 1981.



The fuel fill is less likely to be damaged in a sideswipe when located on the right side of the car. As new models are introduced, the fuel fill will be moved to the right side of the vehicle. This may also offer greater protection to drivers who run out of gasoline on the highway, since they will fill the tank on the side away from the traffic.

#### Structure

In 1979 through 1983, the M, R, and J model cars which have the fuel tank under the floor pan behind the rear wheels, structural reinforcement of the longitudinals on each side of the tank, shielding of any unfriendly surfaces adjacent to the tank, and the design of straps and hangers to limit undesired tank movement will be employed.

#### Truck

##### Fuel Tank Location

The same principles regarding fuel tank location apply to truck design. It is important that these larger fuel tanks are not only shielded from damage in a collision but do not break away from the truck and thereby spread fuel onto the roadway. The approach used by Mitsubishi on the SP-27 of locating the fuel tank ahead of the rear wheels appears to provide good protection for the tank.

The front wheel drive T-115 to be introduced in 1982 will have the fuel tank ahead of the rear wheels and under the rear seat. However, in rear wheel drive trucks there is no clearance over the axle for fuel tank installation and in many cases there is insufficient space ahead of the axle for fuel tanks of the desired capacity.

Chrysler is investigating fuel tank relocation ahead of the rear wheels for vans and multi-purpose vehicles, but present plans for pickups through 1983 and for MPV's and vans through 1985 have the fuel tank located behind the rear wheels. In vehicles both with and without bumpers there is a concern with vertical height differences that create a mismatch with passenger car bumpers. Where fuel tank location behind the rear axle is all that is feasible, a protective impact deflection structure may have to be provided whether or not a bumper is provided. An investigation whether to relocate the fuel tank or to provide impact deflecting structures is presently underway.

##### Fill Neck And Cap

All trucks and vans have side fill. The sweptline pickup truck (DW 1-3) and multi-purpose vehicles (AD-1 & AW-1) will have a recessed fill cap and fuel filler door beginning in 1981.

  
L. L. Baker

## **Attachment 4**



# HANLON BOGLIOLI & HANLON PC

ATTORNEYS AT LAW

ROBERT M. HANLON\*  
BERNARD F. BOGLIOLI\*  
BONNIE H. HANLON\*  
ROBERT M. HANLON, JR.†  
MARY O'KEEFE MASSEY\*  
ROBERT M. COOK‡

WILLIAM F. HANLON (1901-1972)

OF COUNSEL  
ALBERT W. CORNACHIO III†

P.O. BOX 6147  
EDISON, NEW JERSEY 08818  
(732) 346-9555  
FAX (732) 346-1501

HAND DELIVERY  
523 RARITAN CENTER PARKWAY  
EDISON, NEW JERSEY 08837

800 WESTCHESTER AVENUE, S-608  
RYE BROOK, NY 10573  
(914) 220-5322 / FAX (914) 696-0450

WEST LONG BRANCH, NJ  
(732) 229-8020 / FAX (732) 870-0772

RICHARD P. GROSSMAN, JR.\*  
RICHARD J. MIRRA\*  
CHRISTINE GIORDANO HANLON†

\* Admitted NJ Only  
† Admitted NJ & NY  
‡ Admitted NJ & PA  
§ Admitted NY Only

REPLY TO: EDISON

May 1, 2009

Clerk  
Morris County Superior Court  
Morris County Court House  
Washington and Court Streets  
PO Box 910  
Morristown, New Jersey 07963-0910

RE: Kline v. Chrysler LLC, et al  
Docket No. MRS-L-3575-08  
Our File No. 2805

Dear Sir/Madam:

Enclosed are an original and one copy of a Notice of Suggestion of Bankruptcy staying all litigation against Chrysler LLC.

Kindly file same and return a stamped filed copy to this office in the enclosed self-addressed stamped envelope.

Thank you for your attention in this regard.

Very truly yours,

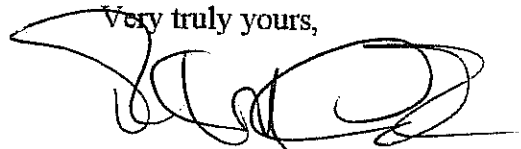

ROBERT M. COOK

RMC/laf  
Enclosures

cc: Angel M. De Filippo, Esq.  
Grieco, Oates & De Filippo, LLC

Margaret M. Mitchell, Esq.  
Weston, Stierli, McFadden & Capotorto

MAY - 4 2009

Kline v. Chrysler LLC, et al  
May 1, 2009  
Page 2

cc: Michael J. Rossignol, Esq.  
Law Office of Michael J. Rossignol

---

James T. Gill, Esq.  
Leary, Bride, Tinker & Moran

**HANLON BOGLIOLI & HANLON PC**

P.O. Box 6147

Edison, New Jersey 08818 (Mailing Address)

523 Raritan Center Parkway

Edison, New Jersey 08837

(732) 346-9555

Attorneys for Defendant, Chrysler LLC

improperly plead as DaimlerChrysler Corporation a/k/a Chrysler Corporation

THOMAS KLINE, as Administrator Ad  
 Prosequendum of the Heirs at Law of SUSAN  
 MORRIS KLINE (Deceased), as Administrator  
 of the Estate of SUSAN MORRIS KLINE, and  
 THOMAS KLINE, Individually

Plaintiffs,

vs.

VICTORIA MORGAN-ALCALA, CARLOS  
 ALCALA, NATALIE RAWLS,  
 DAIMLERCHRYSLER CORPORATION,  
 a/k/a CHRYSLER CORPORATION, LOMAN  
 AUTO GROUP, JOHN DOES, A through Z,  
 (Names being fictitious), ABC  
 CORPORATIONS, 1 through 100, (Names  
 being fictitious),

Defendants.

SUPERIOR COURT OF NEW JERSEY  
 LAW DIVISION: MORRIS COUNTY  
 DOCKET NO. MRS-L-3575-08

Civil Action

**NOTICE OF SUGGESTION OF  
BANKRUPTCY**

**PLEASE TAKE NOTICE THAT** on April 30, 2009 (the "Petition Date"), Chrysler LLC ("Chrysler") and certain domestic direct and indirect subsidiaries (the "Debtors"), filed a voluntary petition for relief in the United States Bankruptcy Court for the Southern District of New York (the "Bankruptcy Court") under chapter 11 of title 11 of the United States Code (the "Bankruptcy Code"), which is being jointly administered and which is pending before the Honorable Arthur J. Gonzalez as Case No. 09-50002 (AJG).

**PLEASE TAKE FURTHER NOTICE THAT**, in accordance with the automatic stay imposed by operation of section 362 of the Bankruptcy Code, from and after the Petition Date no cause of action arising prior to, or relating to the period prior to, the Petition Date, including this action, may be commenced or prosecuted against the Debtors including Chrysler LLC, improperly plead as DaimlerChrysler Corporation a/k/a Chrysler Corporation, in this civil action, and no related judgment may be entered or enforced against the Debtors outside of the Bankruptcy Court without the Bankruptcy Court first issuing an order lifting or modifying the automatic stay for such specific purpose.

Dated: May 1, 2009

**HANLON BOGLIOLI & HANLON, PC**  
**Attorneys for Defendant Chrysler LLC,**  
**improperly plead as DaimlerChrysler**  
**Corporation a/k/a Chrysler Corporation**

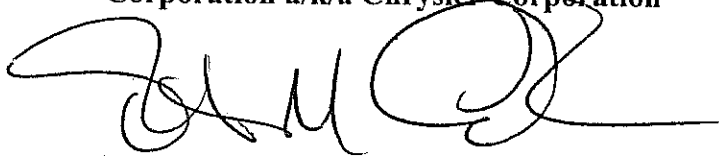

**Robert M. Cook, Esq.**

## **Attachment 5**



Founded in 1852  
by Sidney Davy Miller

# MILLER CANFIELD

M. SHEILA JEFFREY  
TEL (734) 668-7797  
FAX (734) 747-7147  
E-MAIL [jeffrey@millercanfield.com](mailto:jeffrey@millercanfield.com)

Miller, Canfield, Paddock and Stone, P.L.C.  
101 North Main Street, Seventh Floor  
Ann Arbor, Michigan 48104  
TEL (734) 663-2445  
FAX (734) 747-7147  
[www.millercanfield.com](http://www.millercanfield.com)

MICHIGAN: Ann Arbor  
Detroit • Grand Rapids  
Kalamazoo • Lansing  
Saginaw • Troy

FLORIDA: Naples

ILLINOIS: Chicago

NEW YORK: New York

OHIO: Cincinnati

CANADA: Toronto • Windsor

CHINA: Shanghai

MEXICO: Monterrey

POLAND: Gdynia

Warsaw • Wrocław

May 5, 2010

**VIA FACSIMILE (973) 243-2095 AND FEDERAL EXPRESS**

Angel M. DeFilippo, Esq.  
Grieco, Oates & DeFilippo, LLC  
414 Eagle Rock Avenue, Suite 200  
West Orange, New Jersey 07052

Re: Kline (Thomas, et al.) v. Chrysler Corporation, et al.

Dear Ms. DeFilippo:

My firm is discovery counsel for Chrysler Group LLC, which is the custodian of records for Old Carco LLC (f/k/a Chrysler LLC). I am in receipt of the subpoena you served on Chrysler Group LLC. I note that the Notice of Deposition is dated March 10, 2010 and the Order Issuing Subpoena is dated April 2, 2010. However, Chrysler Group LLC was not served with the subpoena until April 28, 2010.

The subpoena directs Chrysler Group LLC either to provide a witness for a records deposition on May 7, 2010 or produce the requested documents prior to May 7, 2010. Because of the belated service of the subpoena, and the voluminous documents sought therein, Chrysler Group LLC is unable either to produce a witness or the documents on May 7, 2010. Chrysler Group LLC will provide responses and objections to the discovery requests appended to the subpoena by May 7, however.

Assuming an appropriate protective order is entered, Chrysler Group LLC will produce the documents by May 28, 2010. Almost all the documents you are seeking contain confidential commercial information. As such, Chrysler Group LLC will not produce these documents without a protective order in place. I will forward a proposed protective order to you with the discovery responses.

Please do not hesitate to contact me if you have any questions.

Sincerely yours,

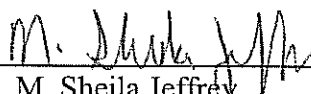
By:   
M. Sheila Jeffrey  
Attorney at Law

MSJ/wsb

cc: Courtney E. Morgan, Jr., Esq. – Via Facsimile (313) 961-8178 and Federal Express  
17,944,035.1\142778-00081

Founded in 1852  
by Sidney Davy Miller

# MILLER CANFIELD

MICHIGAN: Ann Arbor  
Detroit • Grand Rapids  
Kalamazoo • Lansing  
Saginaw • Troy

FLORIDA: Naples

ILLINOIS: Chicago

NEW YORK: New York

OHIO: Cincinnati

CANADA: Toronto • Windsor

CHINA: Shanghai

MEXICO: Monterrey

POLAND: Gdynia  
Warsaw • Wrocław

M. SHEILA JEFFREY  
TEL (734) 668-7797  
FAX (734) 747-7147  
E-MAIL [jeffrey@millercanfield.com](mailto:jeffrey@millercanfield.com)

Miller, Canfield, Paddock and Stone, P.L.C.  
101 North Main Street, Seventh Floor  
Ann Arbor, Michigan 48104  
TEL (734) 663-2445  
FAX (734) 747-7147  
[www.millercanfield.com](http://www.millercanfield.com)

May 5, 2010

**VIA FACSIMILE (973) 243-2095 AND FEDERAL EXPRESS**

Angel M. DeFilippo, Esq.  
Grieco, Oates & DeFilippo, LLC  
414 Eagle Rock Avenue, Suite 200  
West Orange, New Jersey 07052

Re: Kline (Thomas, et al.) v. Chrysler Corporation, et al.

Dear Ms. DeFilippo:

My firm is discovery counsel for Chrysler Group LLC, which is the custodian of records for Old Carco LLC (f/k/a Chrysler LLC). I am in receipt of the subpoena you served on Chrysler Group LLC. I note that the Notice of Deposition is dated March 10, 2010 and the Order Issuing Subpoena is dated April 2, 2010. However, Chrysler Group LLC was not served with the subpoena until April 28, 2010.

The subpoena directs Chrysler Group LLC either to provide a witness for a records deposition on May 7, 2010 or produce the requested documents prior to May 7, 2010. Because of the belated service of the subpoena, and the voluminous documents sought therein, Chrysler Group LLC is unable either to produce a witness or the documents on May 7, 2010. Chrysler Group LLC will provide responses and objections to the discovery requests appended to the subpoena by May 7, however.

Assuming an appropriate protective order is entered, Chrysler Group LLC will produce the documents by May 28, 2010. Almost all the documents you are seeking contain confidential commercial information. As such, Chrysler Group LLC will not produce these documents without a protective order in place. I will forward a proposed protective order to you with the discovery responses.

Please do not hesitate to contact me if you have any questions.

Sincerely yours,

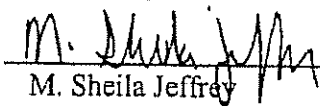
By:   
M. Sheila Jeffrey  
Attorney at Law

MSJ/wsb

cc: Courtney E. Morgan, Jr., Esq. – Via Facsimile (313) 961-8178 and Federal Express  
17,944,035.1\142778-00081

Founded in 1852  
by Sidney Davy Miller

# MILLER CANFIELD

MICHIGAN: Ann Arbor  
Detroit • Grand Rapids  
Kalamazoo • Lansing  
Saginaw • Troy

M. SHEILA JEFFREY  
TEL (734) 668-7797  
FAX (734) 747-7147  
E-MAIL [Jeffrey@millercanfield.com](mailto:Jeffrey@millercanfield.com)

Miller, Canfield, Paddock and Stone, P.L.C.  
101 North Main Street, Seventh Floor  
Ann Arbor, Michigan 48104  
TEL (734) 663-2445  
FAX (734) 747-7147  
[www.millercanfield.com](http://www.millercanfield.com)

FLORIDA: Naples  
ILLINOIS: Chicago  
NEW YORK: New York  
OHIO: Cincinnati

CANADA: Toronto • Windsor  
CHINA: Shanghai  
MEXICO: Monterrey  
POLAND: Gdynia  
Warsaw • Wroclaw

RECEIVED

MAY 06 2010

MORGAN & MEYERS, P.L.C.

May 5, 2010

VIA FACSIMILE (973) 243-2095 AND FEDERAL EXPRESS

Angel M. DeFilippo, Esq.  
Gricco, Oates & DeFilippo, LLC  
414 Eagle Rock Avenue, Suite 200  
West Orange, New Jersey 07052

Re: Kline (Thomas, et al.) v. Chrysler Corporation, et al.

Dear Ms. DeFilippo:

My firm is discovery counsel for Chrysler Group LLC, which is the custodian of records for Old Carco LLC (f/k/a Chrysler LLC). I am in receipt of the subpoena you served on Chrysler Group LLC. I note that the Notice of Deposition is dated March 10, 2010 and the Order Issuing Subpoena is dated April 2, 2010. However, Chrysler Group LLC was not served with the subpoena until April 28, 2010.

The subpoena directs Chrysler Group LLC either to provide a witness for a records deposition on May 7, 2010 or produce the requested documents prior to May 7, 2010. Because of the belated service of the subpoena, and the voluminous documents sought therein, Chrysler Group LLC is unable either to produce a witness or the documents on May 7, 2010. Chrysler Group LLC will provide responses and objections to the discovery requests appended to the subpoena by May 7, however.

Assuming an appropriate protective order is entered, Chrysler Group LLC will produce the documents by May 28, 2010. Almost all the documents you are seeking contain confidential commercial information. As such, Chrysler Group LLC will not produce these documents without a protective order in place. I will forward a proposed protective order to you with the discovery responses.

Please do not hesitate to contact me if you have any questions.

Sincerely yours,

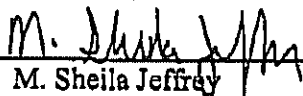
By:   
M. Sheila Jeffrey  
Attorney at Law

MSJ/wsb

cc: Courtney E. Morgan, Jr., Esq. – Via Facsimile (313) 961-8178 and Federal Express  
17,944,025.1\142778-00081

Original - Return 1st copy - Witness 2nd copy - File 3rd copy

DAKLAND COUNTY

10-109074-CZ

STATE OF MICHIGAN  
JUDICIAL DISTRICT  
SIXTH JUDICIAL CIRCUIT  
COUNTY PROBATE

**SUBPOENA**  
Order to Appear and/or Produce



JUDGE RAE LEE CHASOT

KLINE, THOMAS. v. MORGAN, ALCALA  
Court telephone no.

Police Report No. (if applicable)

Court Address  
1200 N. Telegraph Road, Dept. 404, Pontiac, MI 48341

248-858-1000

|  |   |   |
|--|---|---|
| Plaintiff(s) Petitioner(s)<br><input type="checkbox"/> People of the State of Michigan<br><input checked="" type="checkbox"/> IN RE THOMAS KLINE | V | Defendant(s) Respondent(s)<br>VICTORIA MORGAN-ALCALA, et al |
| <input checked="" type="checkbox"/> Civil <input type="checkbox"/> Criminal  |   | Charge  |

Probate In the matter of

In the Name of the People of the State of Michigan. TO: NEW CARCO ACQUISITION LLC, a/k/a  
NEW SCHRYSLER  
30600 Telegraph, Suite 2345  
Bingham Farms, MI 48025

If you require special accommodations to use the court because of disabilities, please contact the court immediately to make arrangements.  
**YOU ARE ORDERED:**

1. to appear personally at the time and place stated below; You may be required to appear from time to time and day to day until excused.

The court address above     Other: 30600 Telegraph Road, Suite 2925, Bingham Farms, MI 48025

|               |               |                   |
|---------------|---------------|-------------------|
| Day<br>Friday | Date<br>May 7 | Time<br>9:00 a.m. |
|---------------|---------------|-------------------|

2. Testify at trial.

3. Produce/permit inspection or copying of the following items: See attached

4. Testify as to your assets, and bring with you the items listed in line 3 above.

5. Testify at deposition.

6. MCL 600.6104(2), 600.6116, or 600.6119 prohibition against transferring or disposing of property attached.

7. Other: The requested items can be copied and mailed to Grieco, Oates & DeFilippo, LLC to meet the subpoena requirements.

8.

|   |                               |              |
|---|-------------------------------|--------------|
| Person requesting subpoena<br>Courtney E. Morgan, Jr. | Telephone no.<br>313-961-0130 |              |
| Address<br>3200 Greenfield, Suite 260                 |                               |              |
| City<br>Dearborn                                      | State<br>MI                   | Zip<br>48120 |



NOTE: If requesting a debtor's examination under MCL 600.6110, or an injunction under Item 6, this subpoena must be issued by a judge. For a debtor examination, the affidavit of debtor examination on the other side of this form must also be completed. Debtor's assets can also be discovered through MCR 2.305 without the need for an affidavit of debtor examination or issuance of this subpoena by a judge.

**FAILURE TO OBEY THE COMMANDS OF THE SUBPOENA OR APPEAR AT THE STATED TIME AND PLACE MAY SUBJECT YOU TO PENALTY FOR CONTEMPT OF COURT.**

April 22, 2010

Date

Judge/Clerk/Attorney Courtney E. Morgan, Jr. (#29137)

|                                 |                                     |
|---------------------------------|-------------------------------------|
| Court use only                  |                                     |
| <input type="checkbox"/> Served | <input type="checkbox"/> Not Served |

| SENDER: COMPLETE THIS SECTION  | COMPLETE THIS SECTION ON DELIVERY  |   |
|--|--|---|
| <p>■ Complete items 1, 2, and 3. Also complete item 4 if Restricted Delivery is desired.</p> <p>■ Print your name and address on the reverse so that we can return this card to you.</p> <p>■ Attach this card to the back of the mail piece or on the front if space permits.</p> | <p>A. Signature</p> <p>X The Corporation Company Agent <input type="checkbox"/> Addressed</p>  |   |
| <p>1. Article Addressed to:</p>  | <p>B. Received by (Printed Name):</p>  | <p>C. Date of Delivery</p> <p>APR 27 2010</p> |
| <p>New CarCo Acquisition LLC<br/>c/o The Corporation Company<br/>30600 Telegraph Road, #2345<br/>Bingham Farms, MI 48025</p>   | <p><input type="checkbox"/> Is delivery address different from item 1? <input type="checkbox"/> Yes<br/> <input checked="" type="checkbox"/> NO <input type="checkbox"/> No</p>  |   |
|  | <p>APR 28 2010<br/>MORGAN &amp; MEYERS P/C</p>   |   |
|  | <p>3. Service type</p> <p><input checked="" type="checkbox"/> Certified Mail <input type="checkbox"/> Express Mail<br/> <input type="checkbox"/> Registered <input checked="" type="checkbox"/> Return Receipt for Merchandise<br/> <input type="checkbox"/> Insured Mail <input checked="" type="checkbox"/> C.O.D.</p> |   |
|  | <p>4. Restricted Delivery? (Extra Fee) <input type="checkbox"/> Yes</p>  |   |
| <p>2. Article Number<br/>(Transfer from service label)</p>   | <p>7008 1300 0001 2716 7757</p>  |   |
| <p>PS Form 3811, August 2001 Domestic Return Receipt 102885-02-M-1540</p>  |  |   |



# Tab 4

CAS letter to Chrysler-Fiat Chairman Sergio Marchionne of September 1, 2011

-----  
Paul V. Sheridan letter of 13 February 2012 to Congressmen:

Representative Elijah Cummings  
Representative James D. Jordan  
Representative Mike Kelly  
Representative Dennis Kucinich

Subject: 1993-2004 Jeep Grand Cherokee Post-Collision Fire Death Defect Investigation  
Reference: House Oversight and Government Reform Hearing (Chevrolet Volt) of 25Jan2012

# CENTER FOR AUTO SAFETY

1825 CONNECTICUT AVENUE NW SUITE 330 WASHINGTON DC 20009-5708  
202-328-7700 [www.autosafety.org](http://www.autosafety.org)

September 1, 2011

Sergio Marchionne, Chairman  
Chrysler Group LLC  
1000 Chrysler Drive  
Auburn Hills MI 48321-8004

Dear Chairman Marchionne:

On May 8, 2011, you gave a commencement address at the University of Toledo in which you stressed social responsibility. You charged: "I believe that the future is not just the responsibility of governments. It's an individual and collective responsibility. It's a challenge that calls for a concerted and shared commitment. Closing our eyes, or thinking that finding a solution is someone else's role, makes us part of the problem."

How apt that you made this address in Toledo the home of the Jeep and where the Grand Cherokee is made because the terrible and rising fire death toll of the 1993-2004 Grand Cherokee represents the largest social responsibility facing Chrysler today. Like a toxic waste site, these vehicles are legacy of the old Chrysler which the new Chrysler is called upon to clean up. As you told the Toledo graduates, "The essence of leadership, when all is said and done, is the personal assumption of the moral duty to be proactive in building our future." The future of the new Chrysler lies in not only the marketability of its new models but also how it handles the legacy of its older models, particularly the toxic 1993-2004 Jeep Grand Cherokee depicted in the hauntingly surreal photo of the burned out hulk of the 1997 Grand Cherokee that terribly burned the Austin sisters and burned Jose Sierra to death. Note the lack of structural damage showing there would have been no injuries but for the fire.



Picture 1 – Austin/Sierra Crash Post Accident Photos

## The Safety Problem

The 1993-2004 Jeep Grand Cherokee is a modern day Pinto for soccer moms. As with the Pinto, the fuel tank is located behind the rear axle: a dangerously vulnerable area in the rear impact crush zone. The tank is made of plastic and has a fuel filler hose that is vulnerable to separation in a rear crash. The tank itself has no valve that would ensure containment of fuel in the event of such a separation. In the United States alone from 1993 through 2009, there have been 184 fatal fire crashes in Jeep Grand Cherokees that have resulted in 269 deaths and numerous burn injuries. At least 78 of the deaths are due to fire according to available medical and government records with the real number of fire deaths higher.

In 2005, under pressure from its merger partner Daimler-Benz, Chrysler moved the fuel tank forward of the rear axle to the safer location used almost universally in light motor vehicles. Despite the fuel tank not only being behind the rear axle but also extending below the rear bumper, a 3 mm fuel tank shield or skid plate produced by Chrysler was not made standard on any 1993-2004 Grand Cherokee. The 1999-2004 Grand Cherokees had an inadequate 1 mm brush guard that did no more than what its name implied – guarded the tank from brush.

In 1978, Chrysler Automotive Safety Manager LL Baker laid out the basic principles for fuel system safety for Chrysler cars and trucks based on the Ford Pinto which included moving the fuel tank ahead of the rear axle and ensuring the filler neck, cap and tube remained attached to the fuel tank to avoid fuel leakage.<sup>1</sup> In SUVs, Baker recommended a protective impact deflection system for the fuel tank recognizing the mismatch between bumpers that allow lower passenger car to come under and impact the fuel tank if it could not be relocated forward of the rear axle in an SUV. Yet none of these recommendations were carried out in the 1993-2004 Grand Cherokee. If they had, many Grand Cherokee crash fire victims would have lived.

The vulnerability of the fuel tank is exacerbated by the dangerous design of the fuel filler hose. In 1993-1998 Grand Cherokees, the filler hose goes through the frame rail unlike any other passenger vehicle. In the event of a rear impact, the filler hose is likely to be pulled out of the fuel tank as the frame rail bends upward. In 1999-2004 Grand Cherokees, Chrysler relocated the filler hose under a redesigned, solid frame rail and improved the connection between the tank and filler hose. With this revised design, the filler hose became vulnerable to separating from the filler cap housing and inlet pipe at its upper end. The plastic fuel tank itself is vulnerable to puncture from sharp objects that are part of either vehicle in a rear impact crash. None of the 1993-2004 models has an effective check valve in the fuel tank to stop fuel flow when the filler hose is pulled loose. Other similar vehicles at that time such as the Ford Explorer and Oldsmobile Bravada had check valves that prevent fuel flow if the filler hose pulled loose from either the tank or the filler neck.

---

<sup>1</sup> “Fuel System Design – Chrysler Passenger Cars And Trucks,” Memo from L.L. Baker, Manager Automotive Safety, to R.M. Sinclair, Director International Product Development, August 24, 1978. (Attachment A from Sheridan Submission to NHTSA Administrator Strickland, February 11, 2011.



Picture 2 – Ineffective Grand Cherokee Check Valve



Picture 3 – 2002 Ford Explorer Check Valve

### **Grand Cherokee Has Highest Fire Death Rate of Similar SUV's – 20 Times Explorer**

Chrysler's own analysis of rear impact fire deaths in NHTSA's Fatal Accident Reporting System database (FARS) shows the Jeep Grand Cherokee to have by far the worst fire death rate of any SUV with more than one fire death. Chrysler's FARS analysis shows 22 fatal rear crashes in nine different 1993-2004 SUVs with fire as the Most Harmful Event - 12 of them in 1993-2004 Jeep Grand Cherokee's. Three of the nine SUVs have no fatal rear MHE fire crashes and three have only one fatal rear MHE fire crash. The Jeep Grand Cherokee with a MHE fire death rate of 0.44 per million vehicle years of use is by far the worst performing SUV in rear impact fire crashes. The Grand Cherokee's biggest competitor, the Ford Explorer with a fuel tank in front of the rear axle had a MHE fire death rate of only 0.02 per million vehicle years of use, making the Grand Cherokee twenty times higher than the Explorer.<sup>2</sup>

The Grand Cherokee fire death rate would be even higher if Chrysler had included the three other rear fire crashes identified by CAS where an occupant of a Grand Cherokee died by fire. And still higher yet if deaths to the occupant in the striking vehicle were included as NHTSA did in the FMVSS 301 rulemaking and the GM Pickup Defect Investigation. Chrysler's FARS analysis did not include Jose Sierra's burn death because he was in the striking vehicle. (See Picture 1.) Nor did it include the burn death of 4 year old Cassidy Jarmon even though Chrysler confidentially settled the case.

<sup>2</sup> See Chrysler presentation to NHTSA, "1993-2004 MY Grand Cherokee Chrysler's Analysis of FARS Data" <http://www-odi.nhtsa.dot.gov/acms/cs/jaxrs/download/doc/ACM17259863> and Center for Auto Safety letter to NHTSA Administrator David Strickland: [https://docs.google.com/viewer?a=v&pid=explorer&chrome=true&srcid=0B08yVa\\_bKjAVODZhNjMzYzYtODQ2Ny00MDM4LTk4OWMtNGVkNDc4ZDIxYmI4&hl=en\\_US](https://docs.google.com/viewer?a=v&pid=explorer&chrome=true&srcid=0B08yVa_bKjAVODZhNjMzYzYtODQ2Ny00MDM4LTk4OWMtNGVkNDc4ZDIxYmI4&hl=en_US)



Picture 4 – Cassidy Jarmon



Picture 5 – Jarmon Crash Photo

### Old Chrysler's Defect Knowledge

Chrysler engineers knew about the deadly defects in the Jeep Grand Cherokee early on. Crash tests conducted by the company demonstrated failures of the fuel tank, frame rail and filler hose connections coupled with fuel flow from the tank unstemmed by any effective check valve. For example, Chrysler Test 5380 had the fuel filler pull out of the fuel tank with a massive leak unstemmed by an effective check valve used by other manufacturers.<sup>3</sup>

Chrysler engineer Judson Estes discussed the problems of both filler hose and fuel tank location in a deposition in *Austin- Sierra v. Chrysler*.<sup>4</sup> Mr. Estes' deposition showed throughout that the behind the rear axle location of the fuel tank in the crush zone led to repeated contact with transmission and suspension components in crash tests. (Id. at 72, 75.) Mr Estes also testified that in crash test 5380 the connection plug holding the fuel hose and vent lines pulled loose from the fuel tank allowing the fuel to flow out of the tank. He attributed this to a failure of the ultrasonic weld securing the plug fitting to the fuel tank. (Id. at 101-04.) This is precisely the failure mode shown in the FHWA crash test depicted below.

<sup>3</sup> Attachment B is test 5380.

<sup>4</sup> A copy of the deposition is posted at <http://www-odi.nhtsa.dot.gov/acms/cs/jaxrs/download/doc/ACM13345717>





Picture 6 – Fuel Filler/Emission Control Line Plate Failure

Mr. Estes went on to testify that the frame rail bent upward and closed on the fuel hose and vent line pulling them away from the tank. (Passim 60-101.) Mr. Estes testified that a frame rail reinforcement bracket was added to keep the frame rail from closing on the fuel lines. (Id. at 117.) The reinforcement bracket added to strengthen the frame rail is shown below.



Picture 7 – Reinforcement Bracket

## **FHWA and CAS Vehicle to Vehicle Crash Tests**

Three recent crash tests of various models of these vehicles conducted by the George Washington University for the Federal Highway Administration (FHWA) and by the Center for Auto Safety have confirmed and demonstrated that the design flaws and vulnerabilities of the fuel tank and its connections result in major fuel spills and fire in rear impacts. All three crash tests were vehicle to vehicle 30% offset rear impacts similar to new Federal Motor Vehicle Safety Standard (FMVSS) 301 with the striking vehicle being a Ford Taurus. Two of the tests were run at the 50 mph impact velocity in FMVSS 301 while the third was run at only 40 mph.

On the earlier models (through the 1998 model year) the filler and the vent hoses are routed through the left rear frame rail while in the later models, they are routed under the left rear frame rail. The earlier models had no standard shield protecting the fuel tank. On the later models, there is either a 1 mm brush guard or a 3 mm skid plate covering the underside of the tank. The skid plate is bolted to the rear frame rails so that the two hoses entering the tank are effectively tied to the frame rail. If the frame rail and fuel tank do not move together in a crash, this forces a separation of the filler hose from the tank. If they do move together, the filler hose can pull lose from the fuel filler inlet.



Picture 8 – Grand Cherokee Fuel Lines Routed through Frame Rail

When these vehicles were marketed, they were among a very few that continued to place the fuel tank behind the rear axle, and they are the only known vehicles that route the fuel filler through the frame rail. Manufacturing the tank out of plastic also makes it vulnerable, in the event of a fuel fire, to being melted or burned so that it can no longer contain any fuel.



The crash tests conducted at the FHWA Turner-Fairbank facility and at KARCO Engineering highlighted significant shortcomings of the Grand Cherokee fuel tank design beyond its location and the routing of fuel lines. The tank has no effective check valve at the entry point of the fuel filler hose that would seal the tank and prevent fuel leakage in the event of a separation of the fuel filler hose from the tank. While it does have a check valve that can prevent backflow into the filler line if the pressure in the tank is greater than atmospheric pressure, that check valve will open once the pressure on either side of the valve is equalized.

Thus, in the first of the KARCO Engineering tests, this valve opened once the vehicle was rolled in the spit test required by FMVSS 30, permitting all of the fuel (actually Stoddard fluid used for testing because it is not flammable) in the tank to flow out. (See Picture 2 for Chrysler check valve.)



Picture 9 – Stoddard Fluid Leaking from Fuel Tank

The fuel filler and vent lines are attached to a small plastic plate that is “welded” to the tank. In the Turner-Fairbank test of a 1995 Grand Cherokee equipped with the optional 3 mm skid plate, this “welding” failed completely and the entire plate came free of the tank. (See Picture 6.) This is precisely the failure mode identified by Chrysler in crash test 5380 and discussed by Chrysler engineer Judson Estes. The back pressure check valve came out along with the attached hoses. This failure left a large hole in the left side of the tank permitting

massive loss of fuel during the impact. The Delta V (change of speed experienced by the Grand Cherokee in the crash) was 23 mph, far below the 35 mph Delta V in NHTSA's New Car Assessment Program which vehicle occupants survive. But for fire, these tests show the occupants should easily survive the crash forces in 50 mph rear impacts.

In the first KARCO Engineering test at 50 mph 30% offset rear impact, the upper end of the fuel filler hose of the 1999 Grand Cherokee came off its attachment to the fuel filler inlet tube. (See Picture 10 below.) When the vehicle was rolled in the spit test required by FMVSS 301, the fuel was free to flow out through the filler tube as shown in Picture 9. In this test, the Delta V was 26 miles/hour. Like the FHWA test, this vehicle was equipped with the 3 mm skid plate.



Picture 10 – Fuel Filler Detachment

Rollover fires are all too common in Jeep Grand Cherokees with the FARS database showing 23 deaths in 15 fatal fire crashes involving rollover of 1993-2004 Grand Cherokees. Of these, 21 were coded by FARS as MHE fire which undercounts actual fire deaths. For example, Bennett Hartsel was burned to death according to the autopsy report in the rollover of the 2002 Grand Cherokee which is shown in Picture 11 below. The lack of an effective check valve used by other manufacturers in their SUV's could have prevented many of these fire deaths.



Picture 11 – Bennett Hartsel Crash

The second KARCO Engineering test of a 1996 Grand Cherokee was conducted at a substantially reduced impact velocity of 40 mph to demonstrate the vulnerability of Grand Cherokees with fuel tanks behind the rear axle in lower speed impacts. This Grand Cherokee was the standard vehicle without the optional plate under the tank. The Delta V was only 21 mph which is a clearly survivable crash if there were no fire. The filler hose remained attached to the tank and to the filler inlet but the tank ruptured and spilled its entire fuel content immediately. (See Pictures 12 & 13 below showing the ruptured tank and the fuel pouring out of the tank into collection containers.).





Picture 12 – 1996 Grand Cherokee Punctured Fuel Tank



Picture 13 – Fuel Leakage from Fuel Tank

The 1993-2004 Jeep Grand Cherokee designed by the old Chrysler Corporation and corrected by relocation of the fuel tank in 2005 by DaimlerChrysler has and will continue to claim a terrible toll of burn victims. As the CEO of the new Chrysler Group LLC who has spoken out about the social responsibility of leaders not to close their eyes to problems but to find solutions, the Center for Auto Safety and the families of victims call on you to recall all 1993-04 Jeep Grand Cherokees and remedy the defects in their fuel systems so this defect does not claim any more victims.

Sincerely,

A handwritten signature in black ink that reads "Clarence Ditlow". The signature is written in a cursive, flowing style.

Clarence Ditlow

Executive Director

# Tab 5

Paul V. Sheridan letter to Mr. David Strickland of September 27, 2011

-----

Paul V. Sheridan letter of 13 February 2012 to Congressmen:

Representative Elijah Cummings  
Representative James D. Jordan  
Representative Mike Kelly  
Representative Dennis Kucinich

Subject: 1993-2004 Jeep Grand Cherokee Post-Collision Fire Death Defect Investigation  
Reference: House Oversight and Government Reform Hearing (Chevrolet Volt) of 25Jan2012



U.S. Department  
of Transportation

**National Highway  
Traffic Safety  
Administration**

1200 New Jersey Avenue, SE  
Washington, DC 20590

OCT 14 2011

David D. Dillon, Sr. Manager  
Product Investigations and Campaigns  
Chrysler Group LLC  
800 Chrysler Drive, CIMS 482-00-91  
Auburn Hills, MI 48326

Re: Request for modification of confidential treatment (PE10-031)

Dear Mr. Dillon:

On September 30, 2011, we received a submission from Paul V. Sheridan requesting that NHTSA modify an existing grant of confidential treatment for engineering drawings submitted by Chrysler Group LLC (Chrysler) in the above referenced investigation. Chrysler submitted this information on October 15, 2010 accompanied by a request for confidential treatment. That request for confidential treatment was granted on March 31, 2011.

NHTSA's October 15, 2010 letter granted your request for confidential treatment on the basis that the engineering drawings in the submission are subject to the class determination for blueprints and engineering drawings found in Appendix B of 49 C.F.R. § 512. As you are aware, Appendix B creates a presumption that release of certain classes of information, including engineering drawings, would be likely to cause a submitter to suffer substantial competitive harm.

Section 512.22 of Part 512 establishes authority for NHTSA's Chief Counsel to modify a prior grant of confidential treatment under certain conditions, including, but not limited to, the passage of time or a finding that a confidentiality determination was erroneous. We are construing Mr. Sheridan's submission as a request that the Chief Counsel consider modification of the March 31, 2011 determination under § 512.22.

Before taking further action in response to Mr. Sheridan's request, we ask that Chrysler state its position regarding the potential release of these drawings. A copy of Mr. Sheridan's submission is enclosed for your review. We request that you respond by October 31, 2011.

After October 24, 2011, intend to make a determination on how to respond to Mr. Sheridan's request. If the Chief Counsel believes that an earlier determination of confidentiality should be modified, you will be notified in writing and provided with an opportunity to respond in not less than twenty working days from the date of receipt of notice of modification.  
49 C.F.R. § 512.22(b).

Sincerely,



Otto G. Matheke, III  
Senior Attorney

Enclosure

cc: Paul V. Sheridan





FedEx Express  
Customer Support Trace  
3875 Airways Boulevard  
Module H, 4th Floor  
Memphis, TN 38116

U.S. Mail: PO Box 727  
Memphis, TN 38194-4643

Telephone: 901-369-3600

October 2, 2011

Dear Customer:

The following is the proof-of-delivery for tracking number **869667283746**.

---

**Delivery Information:**

|                       |                   |                           |                                   |
|-----------------------|-------------------|---------------------------|-----------------------------------|
| <b>Status:</b>        | Delivered         | <b>Delivered to:</b>      | Receptionist/Front Desk           |
| <b>Signed for by:</b> | T.MAPP            | <b>Delivery location:</b> | 1200 N.J. AVE SE W41 306<br>20590 |
| <b>Service type:</b>  | Express Saver Pak | <b>Delivery date:</b>     | Sep 29, 2011 13:11                |

---

**Shipping Information:**

|                         |              |                   |                |
|-------------------------|--------------|-------------------|----------------|
| <b>Tracking number:</b> | 869667283746 | <b>Ship date:</b> | Sep 27, 2011   |
|                         |              | <b>Weight:</b>    | 3.0 lbs/1.4 kg |

**Recipient:**  
MR DAVID STRICKLAND  
NHTSA-WEST BLDG  
1200 NEW JERSEY AVE S E  
20590 US

**Shipper:**  
PAUL SHERIDAN  
SHERIDAN, PAUL V  
22357 COLUMBIA ST  
481243431 US

**Reference**

PE-10031

Thank you for choosing FedEx Express.

FedEx Worldwide Customer Service  
1.800.GoFedEx 1.800.463.3339

To: Mr. David L. Strickland \*  
NHTSA Headquarters/West Building  
1200 New Jersey Avenue, SE  
Washington, DC 20590  
888-327-4236

Date: 27 September 2011

VIA FEDEX AIRBILL #8696-6728-3746

From: Mr. Paul V. Sheridan  
DDM Consultants  
22357 Columbia Street  
Dearborn, MI 48124-3431  
313-277-5095  
[pvs6@Cornell.edu](mailto:pvs6@Cornell.edu)

**Reference : NHTSA Action Number PE10031  
(Jeep Grand Cherokee Fuel System Crashworthiness Defect Investigation)**

**Subject : Chrysler Group, LLC Request for Confidential Treatment of Public Information**

### Courtesy Copy List

Mr. Clarence Ditlow, Director \*\*  
Center for Auto Safety  
Suite 330  
1825 Connecticut Ave, NW  
Washington, DC 20009-5708  
(202) 328-7700

Mr. Courtney E. Morgan, Jr. \*\*  
Morgan & Meyers, PLLC / Suite 320  
3200 Greenfield Road  
Dearborn, MI 48120  
313-961-0130

Ms. Angel M. DeFilippo \*\*  
Grieco Oates & DeFilippo, LLC  
414 Eagle Rock Avenue  
West Orange, NJ 07052  
973-243-2099

\* Available here: <http://links.veronicachapman.com/Sheridan2Strickland-2.pdf>

\*\* Via Email

DDM Consultants  
22357 Columbia Street  
Dearborn, MI 48124-3431  
313-277-5095

27 September 2011

[VIA FEDEX AIRBILL #8696-6728-3746](#)

Mr. David L. Strickland, Administrator  
NHTSA Headquarters  
1200 New Jersey Avenue, SE  
Washington, DC 20590  
888-327-4236

**Reference : NHTSA Action Number PE10031  
(Jeep Grand Cherokee Fuel System Crashworthiness Defect Investigation)**

**Subject : Chrysler Group, LLC Request for Confidential Treatment of Public Information**

Dear Mr. Strickland:

The Chrysler Group has requested the sealing of materials submitted to NHTSA in response to PE10031. This request was made by Mr. David D. Dillon on 15 October 2010 (Attachment 1). Mr. Dillon, who is deployed by the Chrysler Group as a defense witness in product litigation involving fire deaths and/or injuries in the 1993 thru 2004 Jeep Grand Cherokee, stated in-part:

*“The business information for which confidential treatment is sought is 20 engineering drawings . . . This submission is subject to the substantial competitive harm standard set forth in 49 C.F.R. § 512.15(b) . . . The engineering drawings contain the detailed design specifics for various components of two vehicles. Competitors could use this design information to improve their own designs without incurring the time and expense associated with independent design efforts. As a result, Chrysler Group’s competitors could bring to market their products much quicker and at less cost.”*

The purpose of this instant submission is to present why Dillon’s demand, in this instance involving information that has been in the public domain for 25 years, is disingenuous. Although there are additional topics that support this status, I will restrict this presentation to six main topics:

1. Reverse Engineering and Anti-Reverse Engineering
2. Automotive Companies Practice of ‘Competitive Teardown’
3. Competitive Information Office
4. Inter-Automotive Company Defections
5. Chrysler Group relationships with OEM Outside Suppliers (PS-7000)
6. Chrysler Group (MOPAR) relationships with Replacement/Aftermarket Suppliers

### **Reverse Engineering and Anti-Reverse Engineering**

In far too many forums Chrysler Group defense lawyers (in particular) and internal government relations staff have declared that *“reverse engineering is impossible.”* You should presume that such declarations are meant to insult our integrity and intelligence; other than outright inaccuracy, there is no other explanation for such preposterous outbursts.

Accredited four/five-year engineering degree programs (which fulfill Chrysler Group Personnel Office minimums for existing or potential Engineering Department staff) require core coursework in reverse engineering. An entry level engineer is expected to be familiar with and capable of this standardized, routinely taught skill. This is well-known.

Reverse engineering is not a matter of cheating or stealing. It is common that an organization will be forced to reverse engineer a component or system because, through the passage of time, documentation has been lost or mistakenly destroyed.

But the more strident examples of reverse engineering involve military hardware, and its implications for national defense. Reverse engineering is deployed to acquire detailed and exact information about devices and equipment that were created by a strategic opponent. In this context, Chrysler Group LLC is in a special position as an automotive company given its history of transferring Chrysler Defense Group and Chrysler Electronics Group engineers into their automotive engineering departments. I interacted with engineering and product development staff who exemplified this personnel history. In the opposite scenario, Chrysler defense lawyers would do well to educate themselves on the basic history of the Tupolev TU-4; a creation of the Soviet Union that was the result of the infamous reverse engineering of America's Boeing B-29 Superfortress.<sup>1</sup>

But we must stress an esoteric issue. In the area of strategic defense, high-end military suppliers are contractually obligated to include protection by use of anti-reverse engineering designs. If an opponent acquired U.S. military equipment, that opponent would be thwarted, at least for a time, from determining *“design information to improve their own designs without incurring the time and expense associated with independent design efforts.”*<sup>2</sup>

By way of comparison and example, at no time did Mr. Francois Castaing, then Executive Vice President of Chrysler Engineering and Jeep Product Executive, direct that any aspect of any Chrysler product include anti-reverse engineering protections. Also, at no time was a requirement for anti-reverse engineering demanded of our suppliers, which provided up to 55% of Chrysler product content.

As will be detailed below, the moment a competitor acquires a Chrysler product, that product undergoes reverse engineering; a practice that is anything but impossible. The ability to reverse engineer a design that has been protected is difficult, but even that is far from impossible. But the 1993 ZJ-Body Jeep Grand Cherokee, that was designed over twenty years, can easily be reverse engineered. I can assure you our competitors did so immediately upon acquiring the ZJ-Body at market introduction in 1992

It is well-known to Chrysler government relations staff such as Mr. Dillon that reverse engineering in the automotive industry is routine, but that anti-reverse engineering protection is non-existent.

### **Automotive Industry Practice of 'Competitive Teardown'**

As is well-known to Chrysler Group defense lawyers, I have testified about 'Competitive Teardown.' Excerpted below is a portion of my many prior expert reports in behalf of plaintiffs:

*"Throughout my career at Chrysler, my duties pertaining to competitive automobiles included detailed review of competitive engineering of components and systems. Routinely competitive vehicles were fully dismantled by Chrysler technicians from the Competitive Teardown Office. This "teardown" function was/is an integral part of the engineering and product development process. Its purpose was/is to accumulate detailed engineering information of competitive component and system design. The teardown process resulted in the following report and review formats:*

- a. *The Competitive Teardown Review: These formal reviews were presented by the engineering staffs, and frequently attended by the highest levels of Chrysler executive management.*
- b. *Competitive Teardown Report: Documentation which was distributed throughout the Chrysler organization, including the highest levels of Chrysler executive management. These reports included detailed information about competitive components and subsystem content, cost, weight, supplier sources, etc.*
- c. *Reviews by individual engineering or product planning personnel as part of their day-to-day responsibilities. Typically the teardown components were displayed on vertically hung 4 x 8 sheets of plywood, for analysis and inspection by the individual engineering or product planning groups. This display area was affectionately referred to as "The Boards."*
- d. *Competitive Teardown Office visits: Involve open, non-formal inspection on an as-needed basis.*

*As part of my duties at Chrysler I routinely provided managerial input on the selection of which competitive vehicles would be budgeted for teardown. To the best of my knowledge, the practice of Competitive Teardown Review continues at Chrysler to this day."*

During the last two decades no rebuttal to my above trial testimony has been offered into evidence by Chrysler defense lawyers. At no time during my 31-year involvement with the automotive industry has anyone decided that competitive teardown be suspended because *"reverse engineering is impossible."* It was never suggested that the internal funds allocated for Competitive Teardown be axed because it was not valuable, and that the budgetary savings be redirected to other engineering activities. As a former Engineering Programs Manager for Chrysler, I certainly never made any such suggestion.

From 1992 until my *ex parte* dismissal in 1994 I was Chairman of the Chrysler Minivan Safety Leadership Team (SLT). A member of the SLT was Mr. Fred Schmidt of Engineering Programs Management. Part of Mr. Schmidt's role included reports on the selection and scheduling of competitive teardowns. In this context, SLT review of "The Boards" was focused on acquisition of detailed information on competitive safety components and systems. One prominent example in this era was SLT review of competitive minivan liftgate latches that were compliant with FMVSS-206 (Attachment 2).<sup>3</sup>



### **Competitive Information Office**

A standard practice within and among automotive companies is the open solicitation of competitive information directly from competitors. A part of Sales & Marketing, the Chrysler group responsible for this activity was the 'Competitive Information Office' (Attachment 3).

A two-year member of the Chrysler Minivan Safety Leadership Team (SLT) was Mr. Michael Delahanty. He would update the SLT regarding details of existing and anticipated competitive activity. Mr. Delahanty focused on competitive safety components and systems, and also upcoming competitive sales, marketing and advertising claims regarding safety.

Institutionalized inside the industry, Competitive Information Office activity is also known-to and endorsed by defense lawyers, as well as the highest levels of automotive executive management.

### **Inter-Automotive Company Defections**

On June 14, 2011 I attended the deposition of Mr. Francois Castaing, former Executive Vice President of Chrysler Engineering and Jeep Product Executive. He was deposed in the Jeep Grand Cherokee fire-related death case of Kline vs. Lomans Auto Group, et al.<sup>4</sup> In preparation I provided a work file entitled 'Defections.' This file documents a plethora of employment defections between direct competitors at all levels of automotive engineers and executive management.

My file includes pronouncements regarding my former boss, Mr. Robert Lutz.<sup>5</sup> The 3 August 2001 front page Detroit News article, "*LUTZ RIDES IN TO REV UP GM: DCX LOSES VALUED ADVISOR*" explained with gala that Lutz would deploy the detailed information that he acquired during his twelve years at a direct competitor: Chrysler Corporation. But Mr. Lutz is just one example. To emphasize the relevant point made below, a small sampling of my Defections file follows:

1. "VW HIRES FORMER GM EXEC BROWNING AS PART OF SALES DIVISION OVERHAUL" Automotive News, 4 June 2010.
2. "EX-CADILLAC MAN HELPS INFINITI GO GLOBAL" Automotive News, 27 March 2009.
3. "CHRYSLER RECRUITS ANOTHER TOYOTA EXECUTIVE" Automotive News, 2 May 2008.
4. "GM HIRES EX-NISSAN EXEC MCNABB IN SALES REORGANIZATION" Automotive News, 26 Apr 2008.
5. "Chrysler hires Toyota's Meyer to lead global marketing" Automotive News, 15 August 2007.
6. "BIG 3 TALENT JUMPS SHIP TO RIVALS" The Detroit News, 25 April 2005.
7. "DAIMLERCHRYSLER HIGH RANKING OFFICERS LEAVE FOR FORD" Reuters, 1 March 1999.

8. "FORD RECRUITS PLANNER FROM DAIMLERCHRYSLER" Bloomberg News, 1 April 2000.
9. "GM HIRES AWAY PT CRUISER'S DESIGNER FROM DAIMLERCHRYSLER" WSJ, 23 April 2001.
10. "VW NAMES COST-CUTTING FORMER CHRYSLER EXEC TO TAKE OVER MAINSTAY BRAND" Detroit Free Press, 6 October 2004.
11. "DCX EXECUTIVES PINCH-HIT FOR FORD" Automotive News, 16 February 2004.
12. "BRAIN DRAIN: WHY ARE SO MANY TALENTED EXECUTIVES LEAVING FORD" Automotive News, 7 November 2005.
13. "AUDI HIRES MERCEDES MANAGER FOR MARKETING POSITION" Automotive News, 24 May 2006.
14. "FORD COMBATS RAIDS ON TOP DESIGNERS" Automotive News, 7 November 2005.
15. "CHRYSLER DESIGN STAR BOLTS TO FORD" The Detroit News, 2 May 2005.
16. "MITSUBISHI RECRUITS FORD JAPAN CHAIRMAN" Automotive News, 28 May 2002.
17. "GM hires Ford's Devine as CFO" Automotive News, 13 December 2000.
18. "LOVELESS LEAVES CHRYSLER TO JOIN KIA AS SALES CHIEF" Automotive News, 15 June 2007.
19. "MITSUBISHI REPLACES U.S. CEO WITH HYUNDAI'S O'NEILL" The Detroit News, 31 August 2003.
20. "FORMER FORD PR BOSS TO LEAD CHRYSLER PR" Automotive News, 18 December 2003.
21. "DAIMLERCHRYSLER NABS FORD MARKETING PRO" The Detroit News, 21 February 2001.
22. "VOLKSWAGEN CHOOSES FORMER BMW BOSS AS NEW CHIEF EXECUTIVE" The Detroit News, 8 September 2001.
23. "BMW POWERTRAIN LEADER TO HEAD FORD'S GLOBAL R&D" Automotive News, 12 Dec 2000.
24. "ANOTHER FORD MAN WILL TRY TO SAVE MITSUBISHI" Automotive News, 1 April 2005.
25. "DAIMLERCHRYSLER HIRES LEADING GM EXECUTIVE" The Detroit News, 11 May 2000.
26. "VW MIGHT PICK OFF (DAIMLER'S) BERNHARD" Automotive News, 30 August 2004.
27. "NISSAN HIRES VP FROM FORD" Automotive News, 22 May 2003.
28. "OUSTED DAIMLERCHRYSLER EXEC FINDS HOME AT FORD" Automotive News, 26 March 2001.
29. "GM RECRUITS TOYOTA VET AS QUALITY EXPERT" Automotive News, 17 February 2003.
30. "GM VETERAN NAMED PRESIDENT OF TOYOTA" Automotive News, 28 June 2006.

This list of 30 samples is not diatribe; it is meant to serve a relevant point that can be exposed with a few obvious questions:

1. Are we to believe that the inter-automotive company defections, at the highest levels of executive management, are not facilitated by complicity among the corporate defense bar?
2. Are we to believe that the inter-automotive company defections, at all levels of engineering and executive management, were accompanied by “appropriate protective orders” regarding “confidential, proprietary and trade secret information” that was known to be in the possession of these defectors?
3. Are we to believe that recruitment of inter-automotive company defectors, including the highest levels of executive management, targeted only those individuals that were utterly ignorant of “confidential, proprietary and trade secret information”? Or is it well-known that the exact opposite was routinely targeted?

Regarding question #2, I have repeatedly advised plaintiff's, for over sixteen years, to discover such “appropriate protective orders.” None can be legally discovered because none exist (Attachment 4).<sup>6</sup>

### **Chrysler Group relationship with OEM Outside Suppliers (PS-7000)**

Defections of executive management are not restricted to OEM competitors, but extend to the automotive supplier base. A small sampling of that category from my Defections file includes:

- A. “DANA NAMES GM MIKE BURNS CEO” Automotive News, 4 February 2004.
- B. “AUTO SUPPLIER TAPS DAIMLERCHRYSLER EXEC AS CEO” The Detroit News, 18 September 2002.
- C. “HAYES-LEMMERZ HIRES FORMER FORD VP” Automotive News, 23 July 2002.
- D. “GM'S HOGAN DEFECTS TO MAGNA” The Detroit News, 19 August 2004.
- E. “EX FORD EXEC NOW HEAD OF COVARIANT” Automotive News, 28 June 2002.
- F. “FORD'S LIGOCKI LEAVES TO LEAD TOWER” Automotive News, 29 July 2003.
- G. “DELPHI'S ALAPONT LEAVING FOR FIAT TRUCK UNIT” Automotive News, 4 September 2003.
- H. “DURA HIRES FORMER FORD EXEC SZCZUPAK AS COO” Automotive News, 10 December 2006.

In view of defections to & from suppliers, we can also pose the same three questions about “appropriate protective orders.” Again, no such protective orders have ever been sought by the defense bar, and none can be legally discovered.

But an important supplier issue involves Chrysler Group Engineering Standard PS-7000. This public document was first issued in 1979 (after the “Baker memo”).<sup>7</sup> Only minor revisions to PS-7000 have occurred. The Page 12 section “NON-CONFIDENTIALITY” remains in-force:

*“ It is Chrysler’s policy not to enter into formal confidentiality agreements with its suppliers or potential suppliers.*

*To foster the exchange of proprietary information or confidential information, Chrysler and the supplier shall rely on each other’s ethics to handle each other’s proprietary or confidential information in the same manner as each handles its own proprietary or confidential information. ”*

In strict legal terms, the instant that Chrysler documents (such as the “20 engineering drawings” that Mr. Dillon claims are “*subject to the substantial competitive harm standard*”) become the possession of suppliers, said documents become public.<sup>8</sup> Chrysler defense lawyers are fully aware of PS-7000.<sup>9</sup>

The following section provides specificity with respect to Mr. Dillon’s “20 engineering drawings.”

### **Chrysler Group (MOPAR) relationships with Replacement/Aftermarket Suppliers**

The importance, participation and exposure of OEM’s to the replacement/aftermarket industry extends to the Chairman of the Board. For example, both former Chrysler Chairman Robert Eaton and former DaimlerBenz Chairman Jürgen Schrempp were featured on the front cover of SEMA News magazine.<sup>10</sup>

In this context please re-review the 8 January 2010 submission to DP09-005 by Mr. Clarence Ditlow, Director of the Center for Auto Safety (CAS). At their request I had forwarded to CAS pages of the Mitchell International Unibody and Chassis Frame Specifications and Dimensions Manual for the Jeep product line. Please note that I added highlights to emphasize the location and configuration of the defective fuel filler routing issue on ZJ-Body and WJ-Body Jeep Grand Cherokee vehicles.

But importantly, please note the copyright date on the lower portion of the Mitchell International drawings. Note that the 1996 ZJ-Body drawing has a copyright of 1996. Likewise, the 1999 WJ-Body drawing has a copyright of 1999. The 1993 ZJ-Body pages (the first year that the Jeep Grand Cherokee was available) similarly lists a copyright of 1993. Mitchell International, as just one of many aftermarket examples, relied on immediate access to detailed Chrysler drawing information for the purpose of servicing the replacement and aftermarket arena. Their well-known role is the dissemination of detailed specifications and design details which facilitate the work product of replacement and aftermarket suppliers for Chrysler vehicles. A prominent example, that is well-known to Chrysler defense lawyers, is the aftermarket manufacture and sale of Jeep Grand Cherokee skid plates.

In other words, the information contained on the “20 engineering drawings” that Mr. Dillon now claims “*is subject to the substantial competitive harm standard*” because “*competitors could use this design information to improve their own designs*” has continuously been in the public domain concurrent with each model-year introduction of the ZJ-Body and WJ-Body. This is consistent with the fact that PS-7000 also applies to the replacement/aftermarket part suppliers to Chrysler/MOPAR (Attachment 5).

### **Conclusions and Opinion**

In my experience, the concept and legal enforcement of “trade secrets” in Detroit is entirely dependent on the context, and who/what are involved. You should react with suspicion when repeatedly confronted with the reality that so-called confidential information is alleged as such but only when either or both of the following categories are involved:

- i. Product liability litigation
- ii. NHTSA Safety Defect Investigations

But since he is an active defense witness in existing Jeep Grand Cherokee product litigation, the request made by Mr. David D. Dillon on 15 October 2010 involves both categories. Given the six main topics presented above, Mr. Dillon’s claim that 25 year-old data is somehow being sought by competitors is beyond absurd; it is insulting on many levels. In my opinion you should deny the Chrysler Group LLC request that such information receive confidential treatment on at least one crucial basis:

The alleged competitors would not view information that they already have in their possession as “trade secrets.” In this instance, they would view the “*20 engineering drawings*” as confirmation of how **not** to design a fuel system.

Consequently, release of this information could save lives.

Respectfully and sincerely yours,

Paul V. Sheridan

Enclosures/Attachments



## ENDNOTES

---

<sup>1</sup> Regarding PE10031, it is ostensibly suggested Chrysler defense lawyers and internal government relations staff that a massive intercontinental strategic nuclear weapons certified bomber could be reverse engineered, but regarding the 1993 thru 2004 Jeep Grand Cherokee “*reverse engineering is impossible.*”

<sup>2</sup> In the 1970’s I was a personal friend of Dr. Frederick Arlotta, then Chief Systems Engineer at Grumman Aerospace in Bethpage, L.I., New York; assigned to the F-14 Tomcat program. I have been versed in the process of anti-reverse engineering for four decades.

<sup>3</sup> Please review NHTSA file EA94-005.

<sup>4</sup> Unless I am mistaken, the Kline death accident was an example of a highway accident statistic that was not originally included in the FARS data base.

<sup>5</sup> While working for the Dodge Truck Operation Group I reported to and frequently communicated one-on-one with Mr. Lutz.

<sup>6</sup> A typical further example is my former JTE supervisor, Mr. Chris Theodore. He originally worked for Ford Motor Company. Then he worked for General Motors. Then he worked for American Motors Corporation. Then he worked for Chrysler Corporation. After turning down employment solicitation from Nissan, he again worked for Ford Motor Company in 1999. In 1999 Theodore was interviewed by the Automotive News, and stated: “*There are no trade secrets in Detroit.*” Then he worked for at least two different outside suppliers to the Detroit automotive companies. (Mr. Theodore was also the Minivan Platform Engineer during EA94-005, who had insisted, contrary to my SLT, that the Chrysler AS-Body minivan single-stage liftgate latch, which could not comply with FMVSS-206, was not defective. However, Mr. Theodore never volunteered nor appeared to testify in open court regarding his technical rationale/justification for his opinion.)

<sup>7</sup> Please see Enclosure 4/Attachment 3 of the Paul V. Sheridan letter of 9 February 2011 to Mr. David L. Strickland.

<sup>8</sup> Ignore the watermark, placed by Chrysler defense lawyers, which claims that PS-7000 is subject to a protective order; it is not. Like the documents and information described therein, PS-7000 itself is routinely and firstly shared with outside suppliers and merely potential suppliers. The watermark ostensibly but falsely proclaims that a working document that declares non-confidentiality, is confidential (?). It is also common for Chrysler defense lawyers to routinely make documents as if subject to a protective order while being fully aware that such has/have already been in the public domain for years/decades. I have worked with many plaintiffs that were initially tricked by this ruse.

<sup>9</sup> As you are aware, the relationship between the OEM manufacturer and the outside supplier is so close that the latter is self-certified with respect to regulatory compliance with the Transportation Safety Act.

<sup>10</sup> As Chrysler Group LLC defense lawyers are fully aware, I am very active in the replacement and aftermarket (e.g. motorsports) arena. I am a 25-year member of the Specialty Equipment Market Association (SEMA), an annual attendee at the Performance and Racing Industry (PRI) show; I work on and maintain my own vehicles, and have built and driven national record holding race vehicles that have been featured in many automotive enthusiast magazines, etc.

# Attachment 1



**CHRYSLER**

NHTSA  
WASHINGTON, DC 20590

2010 OCT 18 P 4: 35

OFFICE OF CHIEF  
COUNSEL

David D. Dillon  
Sr. Manager  
Product Investigations & Campaigns

October 15, 2010

Mr. O. Kevin Vincent  
Chief Counsel  
National Highway Traffic Safety Administration  
1200 New Jersey Ave., SE, Room W41-227  
Washington, DC 20590

Re: Request for Confidential Treatment of Business Information Submitted in PE10-031

Dear Mr. Vincent:

Chrysler Group LLC ("Chrysler") is submitting information to the NHTSA Office of Defects Investigation (ODI) in connection with the above referenced investigation. Based on a careful review of the submission, Chrysler Group has determined that some of the information is confidential and should be accorded confidential treatment under this agency's regulations at 49 C.F.R. Part 512 and Exemption 4 of the Freedom of Information Act ("FOIA"), 5 U.S.C. § 552(b)(4).<sup>1</sup> Therefore, Chrysler Group is submitting the enclosed CDs together with this request for confidential treatment to the Office of Chief Counsel.

The information required by Part 512 is set forth below.

**A. Description of the Information (49 C.F.R. § 512.8(a))**

The business information for which confidential treatment is being sought is 20 engineering drawings in Enclosure 4 CONF BUS INFO (Bates page #PE10-031-Chrysler-000001 - 000089).

**B. Confidentiality Standard (49 C.F.R. § 512.8(b))**

This submission is subject to the substantial competitive harm standard set forth in 49 C.F.R. § 512.15(b) for information that a submitter is required to provide to the agency.

---

<sup>1</sup> Chrysler Group has taken steps to assure that the CDs are free of any errors or defects that would prevent NHTSA from opening the files on the discs. If, however, the agency is unable to open the files, Chrysler Group respectfully requests that the agency inform Chrysler Group of the issue, so that Chrysler Group may take steps to supply NHTSA's Office of Chief Counsel with a disc that is fully functional.

**C. Justification for Confidential Treatment (49 C.F.R. § 512.8(c))**

This agency's regulations and Exemption 4 of the Freedom of Information Act ("FOIA"), 5 U.S.C. § 552(b)(4), protect the confidentiality of information that would be likely to cause substantial competitive harm to the submitter if disclosed. *See, e.g.* 49 C.F.R. § 512.15(b) *National Parks & Conservation Ass'n v. Morton*, 498 F.2d 765, 770 (D.C. Cir. 1974). FOIA Exemption 4 was enacted to prevent disclosures that would "eliminate much of the time and effort that would otherwise be required to bring to market a product competitive with the [submitter's] product." *Public Citizen Health Research Grp. v. FDA*, 195 F.3d 898, 905 (D.C. Cir. 1999) "Because competition in business turns on the relative costs and opportunities faced by members of the same industry, there is a potential windfall for competitors to whom valuable information is released under FOIA. If those competitors are charged only minimal FOIA retrieval costs for the information, rather than the considerable costs of private reproduction, they may be getting quite a bargain. Such bargains could easily have competitive consequences not contemplated as part of FOIA's principal aim of promoting openness in government." *Worthington Compressors, Inc. v. Costle*, 662 F.2d 45, 51 (D.C. Cir. 1981). Substantial competitive harm also may result from disclosures that would reveal a firm's "operational strengths and weaknesses" to competitors. *See Nat'l Parks & Conservation Ass'n v. Kleppe*, 547 F.2d 673, 684 (D.C. Cir. 1976). The information at issue here should be protected under these standards.

The engineering drawings contain the detailed design specifics for various components of two vehicles. Competitors could use this design information to improve their own designs without incurring the time and expense associated with independent design efforts. As a result, Chrysler Group's competitors could bring to market their products much quicker and at less cost.

**D. Class Determination (49 C.F.R. § 512.8(d))**

The engineering drawings fall within the class determination for "blueprints and engineering drawings." 49 C.F.R. Part 512, App. B(1).

**E. Duration for Which Confidential Treatment is Sought (49 C.F.R. § 512.8(e))**

Because Chrysler Group anticipates that the information will be competitively valuable indefinitely, Chrysler Group requests that the information be accorded confidential treatment permanently.

**F. Contact Information (49 C.F.R. § 512.8(f))**

Please direct all inquiries and responses to the undersigned at:

800 Chrysler Drive, CIMS 482-00-91  
Auburn Hills, MI 48326  
248-512-0087  
dd28@chrysler.com

\*\*\*

If you receive a request for disclosure of the information for which confidential treatment is being sought before you have completed your review of our request, Chrysler respectfully requests notification of the request(s) and an opportunity to provide further justification for the confidential treatment of this information, if warranted.

Sincerely,

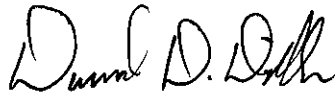

David D. Dillon

cc: Scott Yon  
Lawrence Hershman

Attachment and Enclosures



### Certificate in Support of Request for Confidentiality

I, David D. Dillon, pursuant to the provisions of 49 C.F.R. Part 512, state as follows:

- (1) I am Chrysler Group LLC's Senior Manager, Product Investigations & Campaigns and I am authorized by Chrysler Group LLC to execute documents on its behalf;
- (2) I certify that the information contained in the attached documents is confidential and proprietary data and is being submitted with the claim that it is entitled to confidential treatment under 5 U.S.C. 552(b)(4);
- (3) I hereby request that the information contained in the indicated documents be protected on a permanent basis;
- (4) This certification is based on the information provided by the responsible Chrysler Group LLC personnel who have authority in the normal course of business to release the information for which a claim of confidentiality has been made to ascertain whether such information has ever been released outside Chrysler Group LLC;
- (5) Based upon that information, to the best of my knowledge, information and belief, the information for which Chrysler Group LLC has claimed confidential treatment has never been released or become available outside Chrysler Group LLC, except to certain contractors of Chrysler Group LLC with the understanding that such information must be maintained in strict confidence;
- (6) I make no representations beyond those contained in this certificate and, in particular, I make no representations as to whether this information may become available outside Chrysler Group LLC because of unauthorized or inadvertent disclosure (except as stated in paragraph 5); and
- (7) I certify under penalty of perjury that the foregoing is true and correct.

Executed on this 15<sup>th</sup> day of October, 2010

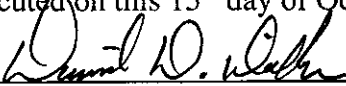
  
\_\_\_\_\_  
David D. Dillon

# Attachment 2



# Inter Company Correspondence

Code  
(sentra)

Date  
June 14, 1991

To-Name & Department

CIMS Number

**SEE BELOW**

From-Name & Department

CIMS Number

|                   |                                     |                    |         |
|-------------------|-------------------------------------|--------------------|---------|
| D. M. Fitzpatrick | Manager-<br>Technical Cost Planning | Chrysler<br>Center | 414-08. |
|-------------------|-------------------------------------|--------------------|---------|

Subject

TO: R.R. Boltz  
F.J. Castaing  
J.G. Damoose  
T.C. Gale  
R.A. Lutz

D.K. Pawley  
T.R. Cunningham  
T.W. Sidlik  
T.T. Stallkamp  
G.C. Valade

## 1991 Nissan Sentra E - Design Cost Study

As a follow-up to the May 12, 1991 teardown review of the 1991 Sentra, you will find attached a cost comparison to the 1994 1/2 PL-Body.

As the cost summary shows, it is estimated that on a design basis the cost of the Sentra exceeds the PL by approximately \$185. Adjusting for the difference between the PL driver and passenger side air bag system and the Sentra motorized seat belt system, the design cost of the Sentra is approximately \$385 over the PL.

Sentra has a number of interesting features that are summarized on page 2.

The contents of this report are:

|                                  | <u>Page</u> |
|----------------------------------|-------------|
| • Overview - "Sentra Features"   | 2           |
| • Dimensional Comparison         | 3           |
| • Weight Comparison              | 4           |
| • Summary of NVH Items           | 5           |
| • Potential Cost Reduction Items | 6           |
| • Cost Summary                   | 7           |
| • Detailed Cost Analysis         | 8           |

The sectioned shell and all individual components are in the Competitive Teardown area in the basement of the W.P. Chrysler Building.

*D.M. Fitzpatrick*  
D.M. Fitzpatrick

Attachments

cc: Distribution List

## **SENTRA FEATURES**

The Sentra was extremely quiet and "stiff" feeling for a \$9,300 car. Dis-assembly showed several NVH and body structural items that were on \$30,000 to \$40,000 cars that contributed to the vehicle's solid feeling.

- **Dash Panel Doubler** - a NVH item made from a mastic backed .026 steel panel that extends from plenum to front floor pan and wheelhouse to wheelhouse.
- **Floor pan mastic** is used with varying thicknesses on the front and center floor, plus, beneath the rear seat cushions. There are additional patches on the cowl plenum lower panel, in the trunk spare tire well and on the rear wheelhouses. Unique is the double layer of mastic on the tunnel at the rear seat cushion and an additional insulator of different material on the floor pan at the rear seat cushion front edge.
- This is the first vehicle that we have dis-assembled that has a hydraulically dampened right side engine mount with three other more "standard" type mounts, an added anti-roll lever and a dedicated isolated engine mount (north/south) crossmember.
- All plastic to plastic contacts in the instrument panel, garnish/trim moldings, console and door pull panels have anti-squeak strips.
- Triple door seals are used, including; a full door surround, door opening upper flange cover and weather seal assembly, and a seal and drip edge that extends from the A-pillar, along the roof and down the C-pillar. (Sentra also has a door to door seal at the B-pillar to close the gap between the doors from the belt to the roof).
- Vehicle stiffness has been accomplished by the use of many frame rail doublers, crossmember reinforcements, added floor pan components and well engineered body panels.
- The Sentra has a two position cam timing system consisting of hydraulic activated helical gears that are activated by an electro-hydraulic solenoid which is monitored by the engine controller.
- The pistons are molybdenum coated for reduced friction.
- A dual chain cam drive system for improved valve train and cylinder head packaging.

# Attachment 3





# Inter Company Correspondence

Telephone

Date

776-2909

January 27, 1993

To-Name & Department

CIMS Number

Please See Below

From-Name & Department

CIMS Number

R. A. Winter

General Product Manager - Minivan Operations C.T.C.

482-08-02

Subject:

## Minivan Safety Leadership Team (SLT)

TO: D.P. Bostwick  
T.M. Creed  
D.E. Dawkins  
R.L. Franson

M.R. Levine  
T.S. Moore  
J.W. Rickert  
P.M. Rosefeld

S.T. Rushwin  
F.I. Sanders  
R.A. Sarotte  
C.P. Theodore  
S.A. Torok

Safety has been an important consideration among Minivan buyers, and Chrysler has enjoyed a leadership position with the implementation of driver's air bag and child seats. The competition has passed us in 1993 by meeting passenger car safety standards, but we will retake the lead in 1994 with passenger side air bags.

In order to maintain our leadership position in this segment we need to provide a vehicle that has the most important safety attributes, and to that end the Minivan Safety Leadership Team is being formed. The purpose of the team is to re-establish Chrysler's advertisable safety leadership position, with particular emphasis on the NS-Body. The general format will focus effort in the areas of "Accident Avoidance", "Accident Survival" and other security issues, and the team will avail itself to all sources of expertise/assistance.

Attached is the current membership listing. Your support/awareness of this activity will enhance the ability of the team in this extremely important task. Your comments are welcome.

R.A. Winter

/sem  
RAW#8\sltmemo

Attachment

**NS-BODY  
SAFETY LEADERSHIP TEAM (SLT)**

- **Background**

- Through its aggressive implementation of the air bag, and other safety related features, Chrysler enjoyed an advertisable safety leadership position through the 1990/1991 timeframe.
- Current and projected competitive activity in the area of safety will erode our leadership position to that of parity, especially in the minivan segment.

- **Purpose/Mission Statement**

- Accurately assess our current and projected status in the area of safety, using the following as a basis for discussion:
  - ▶ 1995 AS-Body exit levels
  - ▶ Documentation/specification of regulatory compliance plans
- Define specific additional requirements/actions to re-establish an advertisable leadership position.
- Focus will be on the NS-Body and the minivan segment, but SLT activity will be formatted to be transferrable/accessible to other platforms.
- Monitor safety innovations.
- Monitor competitive activity.
- Establish/monitor consumer acceptance.

- **Format**

- It is proposed that the SLT examine the safety leadership issue in the context of the following categories:
  - ▶ Accident Avoidance
    - ABS
    - Traction Control/Enhancement
    - Speed Dependent Steering
    - Active Suspension
    - Driver Information Enhancement

- **Format (continued)**

- ▶ **Accident Avoidance (continued)**
  - Exterior Lighting/Signaling
  - Mirrors/Visibility
  - Back-up Alert
  
- ▶ **Accident Survivability**
  - Air Bags (Active)
  - Occupant Restraints (Passive and Active)
  - Crash Management
  - Crash Intrusion
  - Bumper Integrity
  - Side Impact
  - Roof Crush
  - Rollover
  - Seat Back Strength
  - Headrests
  - Glass Retention
  
- ▶ **Other**
  - Anti-theft
  - Security Systems
  - Mechanical Reliability
  - Communications
  - Comfort (anti-fatigue)
  - IVHS

- **Organization/Membership**

- |                              |                                    |
|------------------------------|------------------------------------|
| ● Minivan Operations (Chair) | ● Liberty                          |
| ● Safety Office              | ● Marketing                        |
| ● Engineering                | ● Sales                            |
| ● International Operations   | ● Design Office                    |
|                              | ● Competitive Information Activity |

- ▶ Additional organization involvement will occur as appropriate.

- **Other**

- To be effective, the SLT will require empowerment via executive level recognition of the SLT mission, and resultant dedication of staff support.
- Meeting time tentatively set to alternate with existing Minivan Complexity Team on Tuesdays, 8:15 - 9:00 a.m.
- Initial agenda priority will be review of the NS-Body ABS strategy.



**NS-BODY  
SAFETY LEADERSHIP TEAM (SLT)**

**MEMBERSHIP**

| <b><u>Organization</u></b>       | <b><u>Representatives</u></b>                     | <b><u>CIMS</u></b>     | <b><u>Telephone</u></b> | <b><u>Telefax</u></b> |
|----------------------------------|---|------------------------|-------------------------|-----------------------|
| Minivan Operations *             | Paul V. Sheridan                                  | 482-08-02              | 776-4824                | 776-2261              |
| Safety Office                    | Ronald S. Zarowitz                                | 415-03-21              | 876-1126                | 822-5069              |
| Engineering                      | TBD   |                        |                         |                       |
| International Operations         | Gregory A. Blindu                                 | 415-03-05              | 876-5983                | 876-4752              |
| Liberty                          | TBD   |                        |                         |                       |
| Marketing                        | William H. Hines (Dodge)<br>Mark W. Clemons (C/P) | 414-04-40<br>414-04-35 | 876-5523<br>876-3763    | 822-6957<br>822-6957  |
| Sales                            | James L. Boeberitz                                | 414-05-29              | 876-3942                | 822-7431              |
| Design                           | TBD   |                        |                         |                       |
| Competitive Information Activity | Michael T. Delahanty                              | 414-02-16              | 876-1464                | 876-4241              |

\*Chair

# Attachment 4





# Inter Company Correspondence

Telephone

Date

August 16, 1990

To -- Name & Department

CIMS Number

All Executive Engineers

From -- Name & Department

CIMS Number

H. W. Roush

Group Human Resources Manager -  
Vehicle Engineering and Product Design

418-01-31

Subject:

## POINTS FOR COMMUNICATIONS

### 1. Recruiting - as of 8/15/90

- . July 8 newspaper ad -- 334 responses -- 103 resumes referred to operating levels.
- . August 8 Lendman Career Fair -- 271 interviewed -- 58 resumes referred to operating levels.
- . 15 Engineers have been in for interview to date.
- . Ad for NVH Specialists will run in "Sound and Vibration" Trade Magazine - September issue.

### 2. Resignations

As of August 3 -- our total for the year was 69 -- compared to 73 for all of 1989. 31 of the 69 have gone to Ford.

### 3. Engineers in the News

- . In a special issue of Ebony (August, 1990), Vera Trueblood, an engineer in the Minivan Platform group, is profiled as a successful role model who was recognized as a cost conscience team player by winning the 1989 Chairman's Award. She is a member of Vehicle Engineering's Minority Recruiting team and is also a member of the Board of Directors for the Detroit Urban League.
- . The 1990 International Symposium on Electromagnetic Compatibility will be held in Washington, D.C. from August 21 to 23. This gathering will showcase a research paper co-authored by James P. Muccioli and Scott Ashley. Mr. Muccioli, Scott's supervisor, is part of Small Car Platform under D. E. Florence's group. Mr. Ashley is a Chrysler Institute of Engineering (CIE) student.

### 4. General Communications

The only certainty about communications is that "information" gets passed around every day. Rumors start when people do not know the facts and the reasons behind the facts.

It is not always easy to communicate facts to all areas of the work force -- and - even when we are able to do that -- circumstances can change and the application of factual information will sometimes vary in response to the changes.

We need to continue the emphasis on communications and pass along balanced news. The future of our Corporation is bright and we must continue to emphasize that fact.

Consider some points communicated by Chris Theodore in recent employee meetings:

- . The current situation isn't even close to 1980. What we tend to forget is that many of our people were not here in 1979/1980 -- so this is a new and disconcerting time for them.
- . The last eight years of prosperity is unprecedented in American automotive history.
- . For those people too young to remember - the auto industry has been historically cyclical -- a downturn approximately every four years.
- . Chrysler has the most dedicated product development plan in its history. Most major new products will be domestically engineered. Strategic emphasis is on the automobile manufacturing business.
- . We are dedicated to our people and are making every effort to keep them.
- . We are communicating more with employees and attempting to understand and address their concerns and problems.
- . With our organization in transition, there is a lot of misinformation going around. When you hear or read something -- stop and consider the source -- do the facts support the conclusion? -- does it make sense? --- when in doubt ask your supervisor -- we are committed to getting you an answer.



H. W. Roush

bk

cc:

J. Bahm  
 F. Castaing  
 T. Gallagher  
 C. Gardner  
 J. Mallebay-Macqueur  
 R. P. Marcell

T. Moore  
 J. Nemeth  
 B. Robertson  
 R. Rossio  
 R. Torigian  
 S. Unger

communic.hwr

# Attachment 5

**Howell, Rosa (NHTSA)**

---

**From:** Hershman, Larry (NHTSA)  
**Sent:** Tuesday, January 12, 2010 9:28 AM  
**To:** Howell, Rosa (NHTSA)  
**Cc:** Yon, Scott (NHTSA)  
**Subject:** FW: Jeep Grand Cherokee Fuel System Petition

Rosa,  
Here is another supplement to the Jeep Grand Cherokee petition, file # DP09-005, for inclusion into Artemis.  
Thanks,  
Larry

---

**From:** Demeter, Kathleen (NHTSA)  
**Sent:** Monday, January 11, 2010 11:47 AM  
**To:** Hershman, Larry (NHTSA)  
**Subject:** FW: Jeep Grand Cherokee Fuel System Petition

[Another submission](#)

---

**From:** Clarence Ditlow [mailto:cmdiii@autosafety.org]  
**Sent:** Friday, January 08, 2010 9:58 PM  
**To:** Demeter, Kathleen (NHTSA)  
**Cc:** Yon, Scott (NHTSA)  
**Subject:** Jeep Grand Cherokee Fuel System Petition

Please include and consider in our petition the attached drawings scanned from the Mitchell International 'Unibody and Chassis Frame Specifications and Dimensions Manual.' These manuals are used routinely inside the automotive OEM and repair/service industry.

Please note the mark-ups of the Jeep frame section drawings that depict the location (or lack-thereof) of the fuel filler tube pass-thru holes. The yellow comment boxes have been added only to highlight the subject locations.

At the Center's request, Paul Sheridan has personally inspected many model-year versions of Jeep Cherokee and Jeep Grand Cherokee vehicles to confirm that the fuel filler tube is made of rubber and passes through the frame rail in 1993-98 Jeep Grand Cherokees and under the frame rail in 1999-04 Jeep Grand Cherokees. We are sending out another investigator to examine Grand Cherokees in Florida to confirm this information. Also attached are detailed photos of the steel filler neck, the rubber filler tube and the plastic tank in the Grand Cherokee examined by MVFRI.

This is a defective design of the fuel filler tube whose performance is not measured by FMVSS 301.

Please do not hesitate to contact me as needed.

Paul Sheridan

Clarence Ditlow  
Executive Director  
Center for Auto Safety  
1825 Connecticut Ave NW  
Washington DC 20009

DP09-005  
ATTACHMENT



Fig. 2 Frame Alignment Reference Dimensions—XJ Vehicles

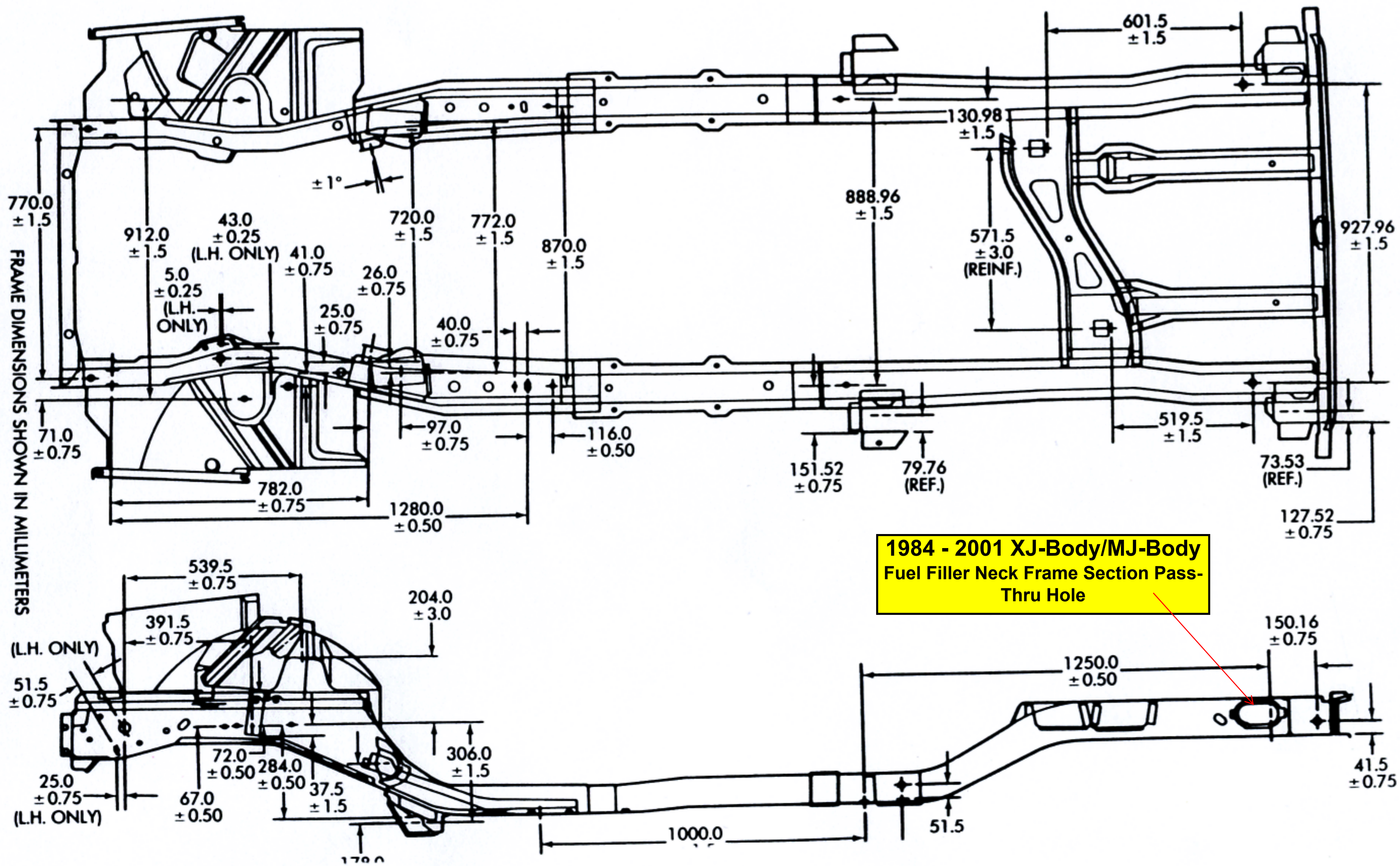



# 1996 JEEP GRAND CHEROKEE 2WD/4WD

105 15/16" (2691mm) WHEELBASE

## UNDERHOOD VIEW

UNDERHOOD VIEW POINT-TO-POINT DIMENSIONS ARE TAKEN WITH TRAM BAR POINTERS SET AT EQUAL LENGTHS. Bolts and Studs are Measured to Center. Holes are Measured to Closest Edge.

## BOTTOM VIEW

BOTTOM VIEW POINT-TO-POINT DIMENSIONS ARE TAKEN WITH TRAM BAR POINTERS SET AT EQUAL LENGTHS. Bolts and Studs are Measured to Center. Holes are Measured to Closest Edge.

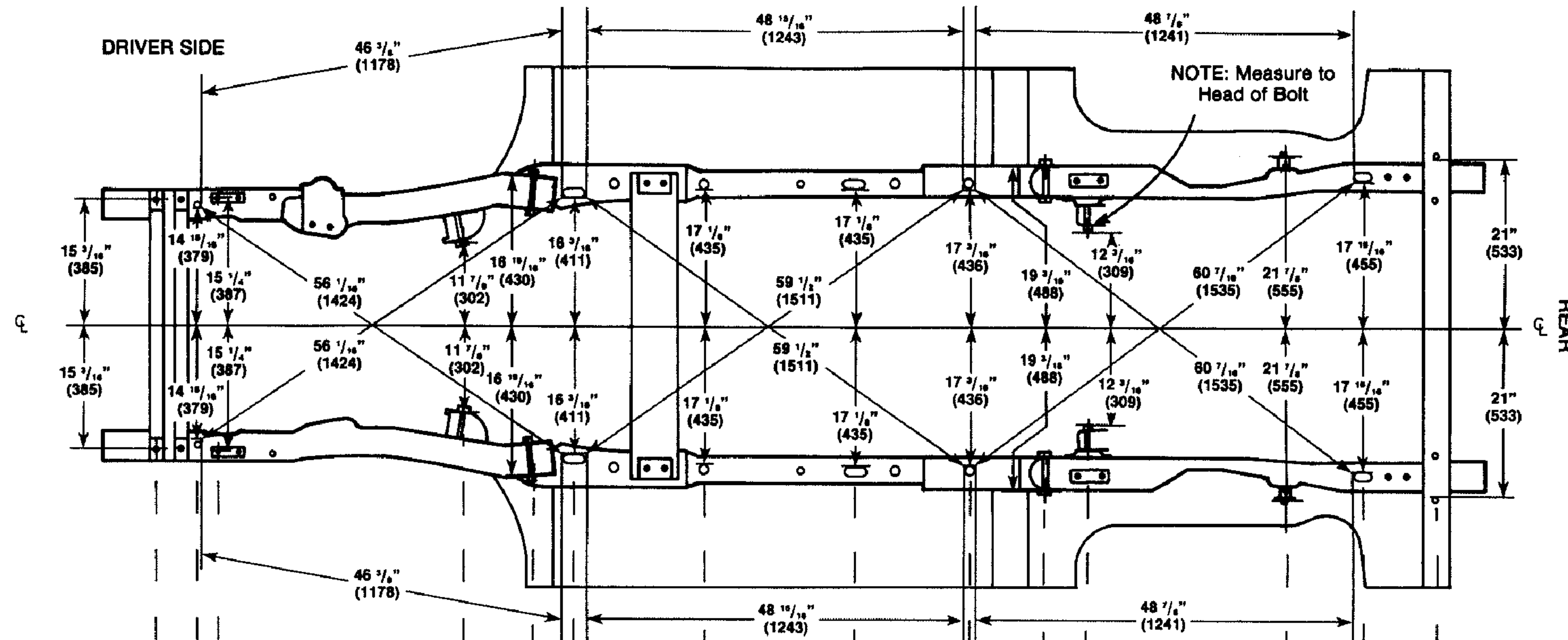
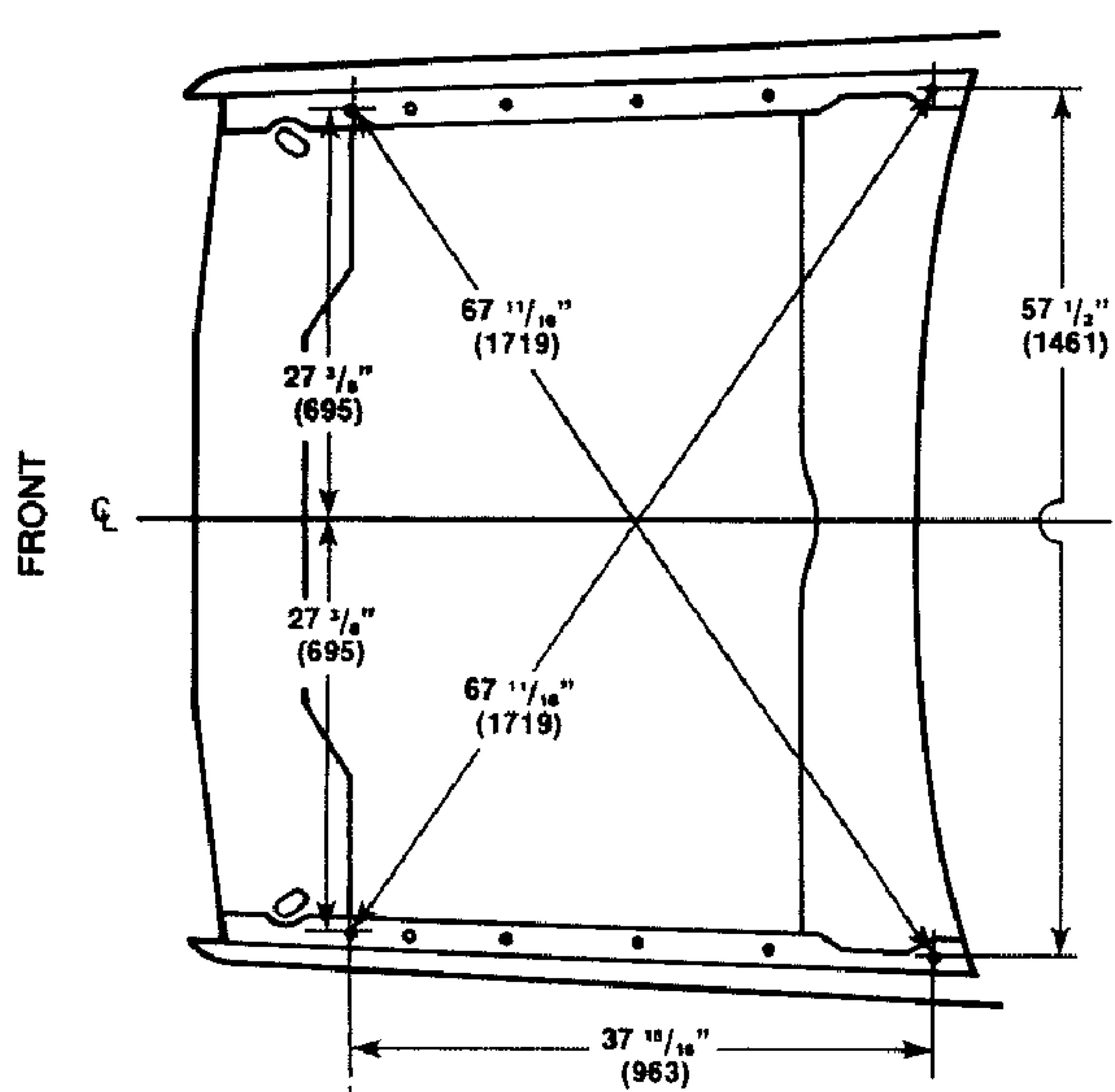

**1993-1998 ZJ-Body:**  
Fuel Filler Tube  
Frame Section  
Pass-Thru Hole

See "C" for Datum Height and Length

Top of Front Fender Bolt on Core Support

**SIDE VIEW**  
Datum Height Dimensions are PERPENDICULAR to Datum Plane. Datum Length Dimensions are PARALLEL to Centerline of Vehicle, and are Measured Center-to-Center.

### MEASURING POINTS

- A = Bolt
- B = 3/16" (14) - Threaded Hole
- C = Front Fender Bolt
- D = Bolt
- E = Bolt
- F = Bolt
- G = 3/8" x 1" (19 x 25)
- H = 3/4" (19)
- I = 3/8" x 1" (19 x 25)
- J = 3/4" (19)
- K = Bolt
- L = Bolt
- M = Bolt
- N = 3/8" x 1" (19 x 25)
- O = 1/2" (13)

**OVERALL DATUM LENGTHS**  
B to G = 46 1/8" (1175mm)  
G to J = 49 3/4" (1264mm)  
J to N = 49 3/16" (1250mm)

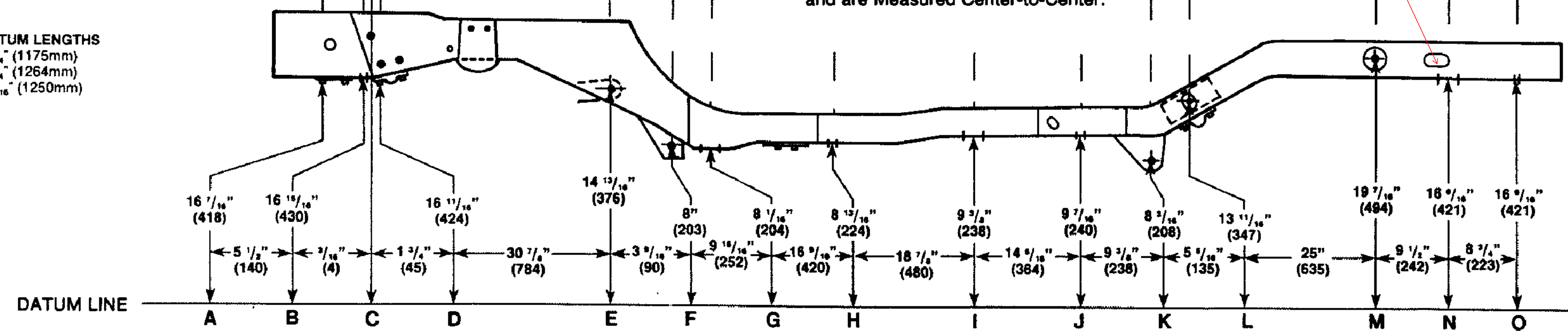

SEE PROCEDURE EXPLANATION



**UNDERHOOD VIEW**  
 UNDERHOOD VIEW POINT-TO-POINT DIMENSIONS ARE TAKEN WITH TRAM BAR POINTERS SET AT EQUAL LENGTHS. Bolts and Studs are Measured to Center. Holes are Measured to Closest Edge.

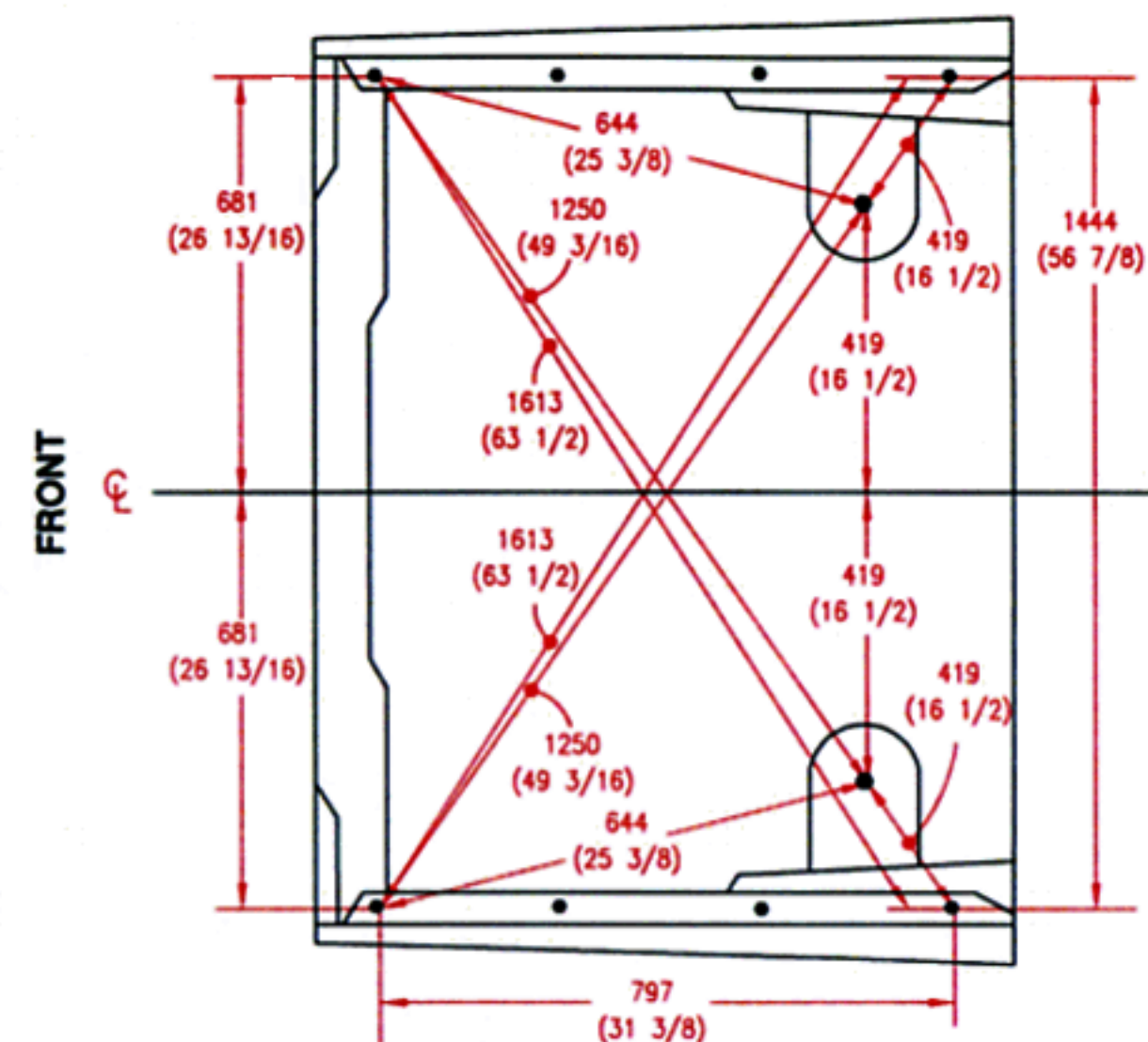

See "C" for Datum Height and Length

**BOTTOM VIEW**  
 BOTTOM VIEW POINT-TO-POINT DIMENSIONS ARE TAKEN WITH TRAM BAR POINTERS SET AT EQUAL LENGTHS. Bolts and Studs are Measured to Center. Holes are Measured to Closest Edge.

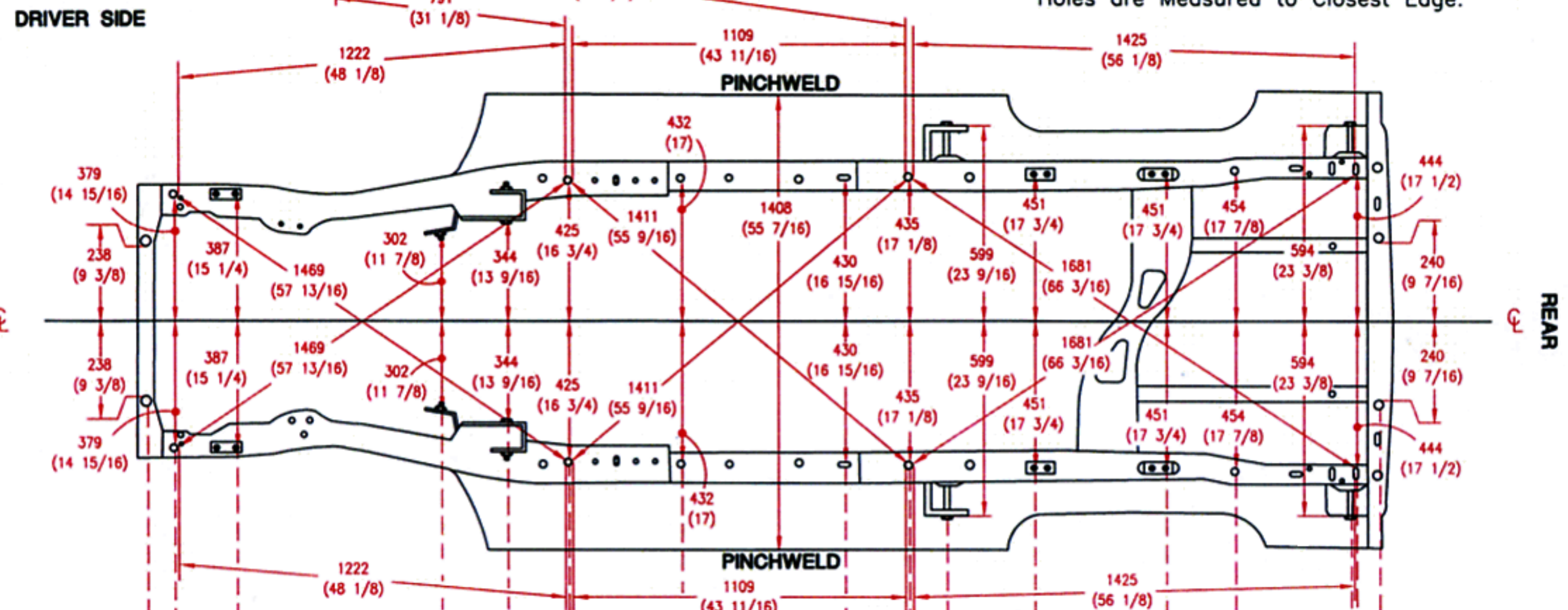

Top of Front Fender Bolt on Core Support

1999-2001 XJ-Body:  
 Fuel Filler Tube Pass-Thru Hole DELETED from Frame Section;  
 Fill Tube Routing Revised to 'Under-Frame' Configuration

**MEASURING POINTS**

- A = 26 (1)
- B = 16 (5/8)
- C = Front Fender Bolt
- D = Bolt
- E = Bolt
- F = Bolt
- G = 19 (3/4)
- H = 19 (3/4)
- I = 26 x 32 (1 x 1 1/4)
- J = 19 (3/4)
- K = Bolt
- L = Bolt
- M = Bolt
- N = 19 (3/4)
- O = Bolt
- P = 13 x 20 (1/2 x 13/16)
- Q = 22 (7/8)

**OVERALL DATUM LENGTHS**  
 B to G = 1224 (48 3/16)  
 G to J = 1128 (44 7/16)  
 J to P = 1430 (56 5/16)

**SIDE VIEW**  
 Datum Height Dimensions are PERPENDICULAR to Datum Plane. Datum Length Dimensions are PARALLEL to Centerline of Vehicle, and are Measured Center-to-Center.

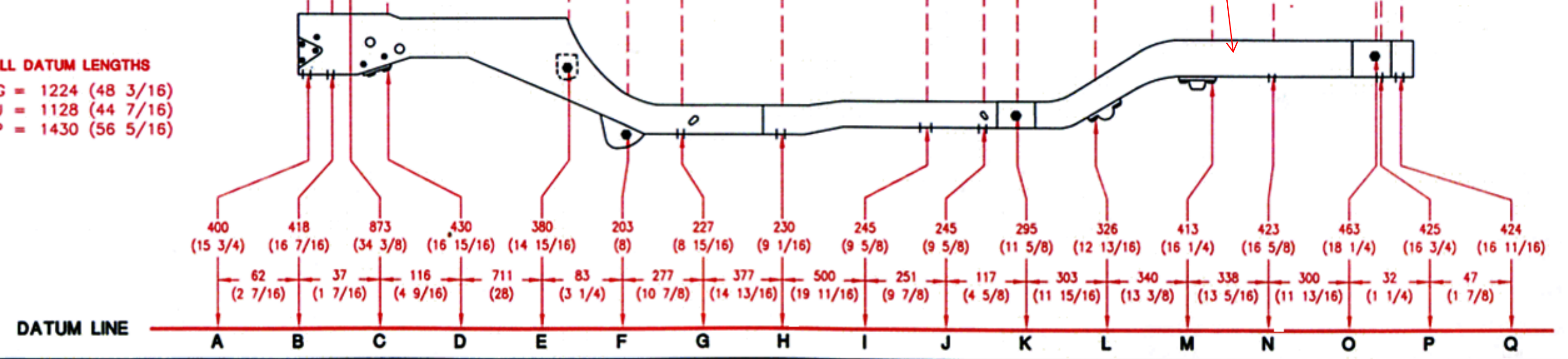



# 1999 JEEP GRAND CHEROKEE 4WD

2690 (105 7/8) WHEELBASE

**UNDERHOOD VIEW**  
 UNDERHOOD VIEW POINT-TO-POINT DIMENSIONS ARE TAKEN WITH TRAM BAR POINTERS SET AT EQUAL LENGTHS. Bolts and Studs are Measured to Center. Holes are Measured to Closest Edge.

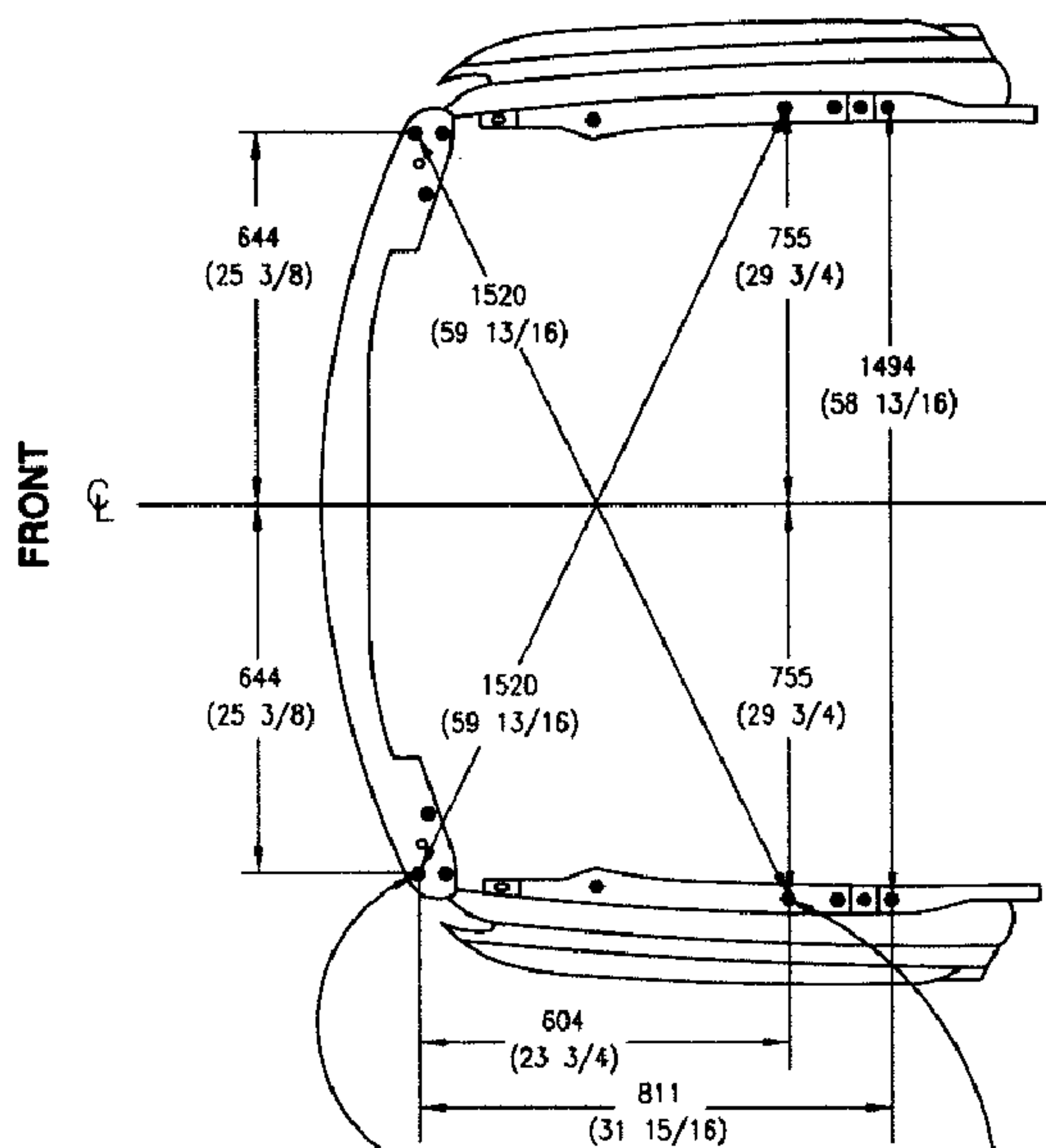

See B for Datum Height and Length  
 See D for Datum Height and Length

**NOTICE**  
 All Dimensions to Bolts are Measured to Head or Tip.  
 ON THIS PAGE

**BOTTOM VIEW**  
 BOTTOM VIEW POINT-TO-POINT DIMENSIONS ARE TAKEN WITH TRAM BAR POINTERS SET AT EQUAL LENGTHS. Bolts and Studs are Measured to Center. Holes are Measured to Closest Edge.

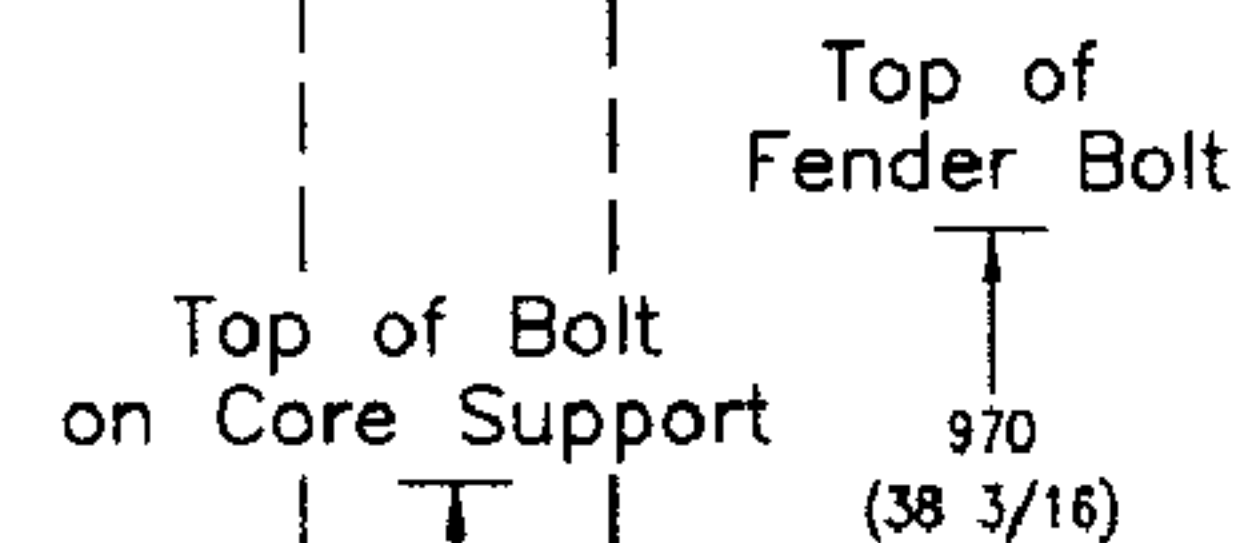
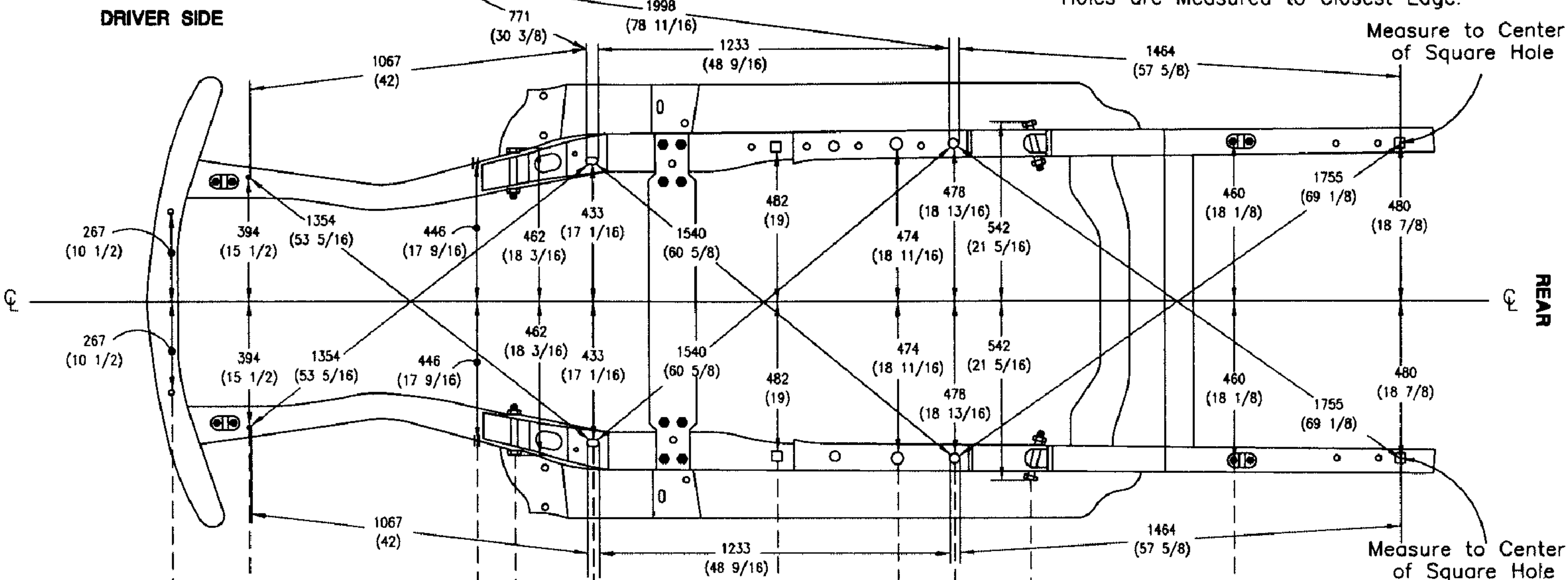

**SIDE VIEW**  
 Datum Height Dimensions are PERPENDICULAR to Datum Plane. Datum Length Dimensions are PARALLEL to Centerline of Vehicle, and are Measured Center-to-Center.

**1999-2004 WJ-Body:**  
 Fuel Filler Tube Pass-Thru Hole DELETED from Frame Section; Fill Tube Routing Revised to 'Under-Frame' Configuration

- MEASURING POINTS**
- A = 14 (9/16)
  - B = Bolt-Core Support
  - C = 8 (5/16) Threaded Hole
  - D = Fender Bolt
  - E = 12 (1/2)
  - F = Bolt
  - G = 17 x 33 (11/16 x 1 5/16)
  - H = 19 x 19 (3/4 x 3/4) Square Hole
  - I = 33 (1 5/16)
  - J = 25 (1)
  - K = Bolt
  - L = Bolt
  - M = 19 x 19 (3/4 x 3/4) Square Hole
- OVERALL DATUM LENGTHS**
- C to G = 1063 (41 7/8)
  - G to J = 1261 (49 5/8)
  - J to M = 1458 (57 3/8)

DS = Driver Side  
 PS = Passenger Side

DATUM LINE

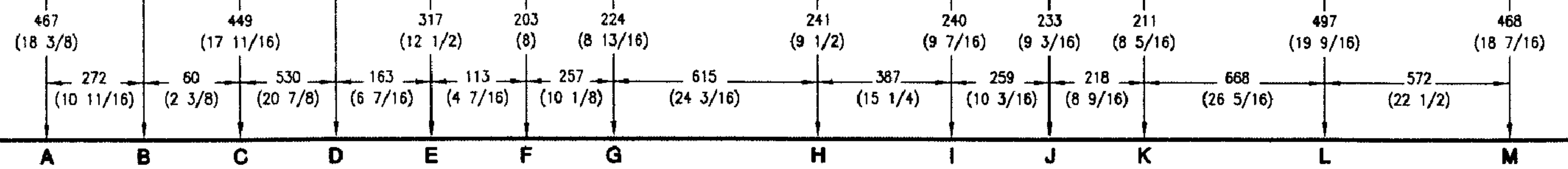

SEE PROCEDURE EXPLANATION

© 1999 MITCHELL INTERNATIONAL







PICK  
A03045L  
52100380A  
1  
PART NO.  
(0516000)  
PART NO. 0516000



ALL INFORMATION CONTAINED HEREIN IS UNCLASSIFIED

DATE 08-10-2010 BY 60322/UC/STP

02



# Attachment 6



OUTSIDE DESIGNED AND DEVELOPED ITEMS  
(ODD BOX ITEMS)  
ABSTRACT

This process standard establishes the business relationship between Chrysler Corporation and Suppliers of outside (supplier) design and development (ODD Box) items. An ODD Box is a part, assembly, component, or sub-system designed, developed, tooled, and produced by a supplier or jointly by a supplier

CONTENTS

| <u>Topic</u>  | <u>Paragraph</u> | <u>Page</u> |
|---|------------------|-------------|
| General   | 1.0              | 2           |
| Organizations Identified in this Standard                                   | 2.0              | 2           |
| Chrysler Approval of a Supplier   | 3.0              | 2           |
| Design  | 4.0              | 3           |
| Drawings/CATIA Models   | 5.0              | 3           |
| Supplier Specifications (Standards)   | 6.0              | 4           |
| Use of Approved Subsources  | 7.0              | 4           |
| Safety, Regulatory, Regulated Substance, Recyclability, & Export Compliance | 8.0              | 4           |
| Start of Production Tooling   | 9.0              | 6           |
| Construction and Certification of Tooling Aids                              | 10.0             | 6           |
| Control of Changes  | 11.0             | 6           |
| Record Retention  | 12.0             | 7           |
| Quality Assurance   | 13.0             | 7           |
| Warranty Responsibilities   | 14.0             | 9           |
| Serviceability and Service Parts Requirements                               | 15.0             | 9           |
| Control   | 16.0             | 10          |

APPENDICES

|   |    |
|---|----|
| A Intellectual Property Rights, Disclosure, and Non-Confidentiality | 11 |
| B Glossary (Including Definitions)                                  | 12 |

A single asterisk "\*" after the paragraph header denotes a technical change to the paragraph. A triple asterisk before and after an item (\*\*\*) identifies the specific changed text.

| Date        | Mdl. Yr. | Eff. Code & Disp Code | PCN No.                                     | Change | Text Changes and Cancellations |
|-------------|----------|-----------------------|---|--------|--------------------------------|
| 6/26/95     |          |                       | Editorial                                   | J      | Certain references updated     |
| 10/31/94    |          |                       | Editorial                                   | H      | Revised FMEA reference         |
| Date Issued | 10/25/79 | Dept 2610             | Contact Supv., Engr. Stds. & Info. Services |        |                                |

**IMPORTANT:** Chrysler Corporation standards, specifications and drawings are subject to frequent revision. It is the users' responsibility to comply with current versions. Distribution of standards to parties other than Chrysler Corporation suppliers, whether with or without charge, is for information only. A subscription service is available at reasonable cost, which will automatically provide the subscriber with current standards. Subscription information or copies of current standards are available from the Engineering Standards & Information Services Department, Vehicle Engineering Office, Chrysler Corporation.

C References

15

Subject to Protective Order - Thomas vs. DaimlerChrysler Corporation

A single asterisk "\*" after the paragraph header denotes a technical change to the paragraph. A triple asterisk before and after an item (\*\*\*) identifies the specific changed text.

| Date<br>Cancellations | Mdl. Yr. | Eff. Code & Disp Code | PCN No.                                     | Change | Text Changes and           |
|-----------------------|----------|-----------------------|---|--------|----------------------------|
| 6/26/95               |          |                       | Editorial                                   | J      | Certain references updated |
| 10/31/94              |          |                       | Editorial                                   | H      | Revised FMEA reference     |
| Date Issued           | 10/25/79 | Dept 2610             | Contact Supv., Engr. Stds. & Info. Services |        |                            |

**IMPORTANT:** Chrysler Corporation standards, specifications and drawings are subject to frequent revision. It is the users' responsibility to comply with current versions. Distribution of standards to parties other than Chrysler Corporation suppliers, whether with or without charge, is for information only. A subscription service is available at reasonable cost, which will automatically provide the subscriber with current standards. Subscription information or copies of current standards are available from the Engineering Standards & Information Services Department, Vehicle Engineering Office, Chrysler Corporation.



This standard is for use in supplying certain parts under purchase orders of Chrysler Corporation or its subsidiaries. This standard is limited in its application to those drawings, CATIA Models, Engineering Graphics, or Operation Description Sheets which call out this standard number, or which refer to this standard within some other standard or specification. Original equipment and replacement parts for some vehicles sold by Chrysler Corporation or its dealers are not covered by this standard. Special Interest Vehicle Program ("Package Program") designs and modifications, done by an outside supplier, must conform to the requirements in this standard.

## 1.0 GENERAL

### 1.1 Purpose

- To define an outside designed and developed item (ODD Box Item). Refer to the Glossary at the end of this standard.
- To define and establish Chrysler Corporation and supplier responsibilities regarding parts, assemblies, components, and sub-systems furnished to Chrysler Corporation as ODD Box items.
- To recommend quote package content. Refer to the Glossary at the end of this standard.
- To assist in identifying drawings/CATIA models as supplier designed and developed.

### 1.2 Changes from the Previous Edition\*

\*\*\* Reference to the SQA manual has been superseded by reference to QS-9000. Corporate Procedure 189 has been superseded by Corporate Process Guideline 057. \*\*\*

## 2.0 ORGANIZATIONS IDENTIFIED IN THIS STANDARD

The following organizational titles refer to functional entities within Chrysler Corporation.

|                                       |   |
|---------------------------------------|---|
| Assembly Plant                        | Procurement and Supply Office               |
| Corporate Patent Office               | Supplier Development (Quality)              |
| Engineering (Lead Vehicle Engr. Dept) | Supplier Management (Purchasing)            |
| Fastener Engineering                  | Product Development Team                    |
| Manufacturing Plant                   | Safety Programs                             |
| Mopar Parts Division                  | Supplier Quality Lab                        |
| Cataloging                            | Vehicle Assembly Plant                      |
| Service Parts Analysis                | Vehicle Engineering Homologation Department |
| Tool Engineering                      | Vehicle/Components PF Safety Systems        |

## 3.0 CHRYSLER APPROVAL OF A SUPPLIER

The supplier must have full source approval, as described in Vehicle Engineering and Procurement and Supply Offices' procedures before purchase orders for design, development, or production are issued. Any deviations must be approved by Chrysler Corporation's Procurement and Supply Office. Design Verification of an ODD Box item is not a substitute for these procedures.



#### 4.0 DESIGN

Design and performance requirements are specified in the quote package, i.e. Performance Standard.

#### 4.1 Intellectual Property Rights, Disclosure, and Non-Confidentiality

Intellectual property rights, disclosure, and non-confidentiality are described in Appendix A at the end of this standard.

#### 4.2 Standard and Semi-Standard Parts

The supplier shall utilize whenever feasible Chrysler standard and semi-standard parts, purchased from approved sources. Metric fasteners shall be utilized in accordance with Chrysler's program for that vehicle family. Refer to Fastener Engineering and to the Standards Parts Book for further information.

#### 5.0 DRAWINGS/CATIA MODELS

- Detailed drawings/CATIA models are required for any component parts appearing in the Chrysler Bill of Material. Supplier must submit all drawings/CATIA models, requested in the quote package, to the Product Development Team.
- It is the responsibility of Engineering to determine the level of component detail to be carried in the Engineering Bill of Material and to subsequently manage and communicate changes to the Bill of Material by the appropriate change document.
- Detail component drawings/CATIA models intended to be released:
  - must be prepared in accordance with the Chrysler CATIA Standards Reference Manual CEP-002 and the Drawing Standards Manual CEP-004. Any deviation must be approved by the responsible engineering design, releasing, and Procurement and Supply activity.
  - must detail all interfaces with associated parts and components.
  - become the property of Chrysler Corporation.
  - must show PS-7000 and the words "ODD Box" in the standards block or comment page.
  - must list all the applicable standards in the standards block or comment page in accordance with the standards entry guidelines in Engineering Operations Bulletin 93-2. The following standards shall be listed as applicable:

|                      |   |                                     |
|----------------------|---|-------------------------------------|
| Safety or Regulatory | PF-Safety<br>PF-Noise   | PF-Emissions<br>PF-Theft Prevention |
|                      | PS-9336, "Homologation Requirements"  |                                     |
| Part Identification  | PS-4480, "Identification of Parts"  |                                     |
| Quality Assurance    | PS-7300, "Quality Assurance Diamonds"<br>PS-8335, "Pentagon - Critical Verification Symbol"<br>PS-9500, "Hydrogen Embrittlement Relief" |                                     |

Chrysler Performance Standard(s) related to the part  
Other Standards if not already referenced within the Performance Standard



- Engineering shall confirm that the list of standards in the standards block or comment page is complete and accurate and approve (sign-off) the drawing/CATIA model before its release.
- Engineering will identify critical:
  - safety/regulatory characteristics and direct the supplier to apply the shield symbol to the drawings/CATIA Models where appropriate.
  - non-safety/non-regulatory characteristics in conjunction with Procurement and Supply and direct the supplier to apply the diamond or pentagon symbols as appropriate.

Refer to the Drawing Standards, Shields-Critical Characteristics, Diamonds-Critical Characteristics, and the Pentagon-Critical Verification Symbol manuals.

**NOTE**

Supplier Development shall approve each application of "diamonds" and "pentagons" and sign-off for PS-7300 and/or PS-8335 respectively in the standards block on the drawing or comment page on the CATIA model.

- Supplemental detail information not shown on released drawings/CATIA models shall be shown on drawings/CATIA models done on supplier forms and submitted to Engineering.
- If a supplier drawing is overlaid on a Chrysler form and is no longer to scale, the drawing must be clearly marked "Do not Scale." The Chrysler Corporation title block must always be in the lower right hand corner of the drawing.
- CAD/CAM Data exchange must conform to Chrysler's Data Exchange Policy covered in PS-9227 and in Corporate Engineering Publication CEP-001.

**6.0 SUPPLIER SPECIFICATIONS (STANDARDS)**

If specified in the quote package, the supplier will submit internal specifications (standards) for the ODD Box to Engineering.

**7.0 USE OF APPROVED SUBSOURCES**

When a referenced Engineering Standard includes an Engineering Approved Source List (EASL) as an addendum, materials, processes, and components must be purchased from suppliers listed. Engineering and Procurement and Supply Offices must review any proposed deviation. The supplier is completely responsible for the quality of the end-item regardless of whether the components are purchased from an approved source or not.

**8.0 SAFETY, REGULATORY, REGULATED SUBSTANCE, RECYCLABILITY, AND EXPORT COMPLIANCE \***

Engineering shall make known the safety and regulatory requirements to the supplier and the supplier shall assure such requirements are incorporated into their products.



A. Engineering responsibilities include:

- reviewing the following documents:
  - \*\*\* Corporate Process Guideline ADM057 Vehicle Safety/Emissions/Noise/Theft Regulation Compliance. \*\*\*
  - Shields - Critical Characteristics Manual.
  - Applicable safety and regulatory standards.
  - Applicable Chrysler Compliance Procedures and MASSEs.
- clearly identifying to the supplier safety/regulatory requirements, including
  - any labelling or customer information needs.
  - certification requirements.
  - responsibility for compliance reports, documentation, etc.
- assuring that the Chrysler Performance Standard identifies specific safety and regulatory requirements.
- consulting with Safety Programs to verify that safety and regulatory requirements are being conveyed via the applicable source documents.
- consulting with the Vehicle Engineering Homologation Department to determine requirements for items and vehicles that require certification before export. Refer to PS-9336 and to Engineering Operations Bulletin 93-1.

B. The supplier must:

- consult with Engineering to assure the item meets safety and regulatory guidelines.
- submit reports and retain records as described in the \*\*\* Chrysler, Ford, and General Motors manual, Quality System Requirements QS - 9000. \*\*\*
- In conjunction with Engineering, identify critical safety and regulatory characteristics on the drawing/CATIA model. Refer to the Shields - Critical Characteristics Manual.
- identify safety, regulatory, or homologation concerns by including the appropriate Chrysler standard in the standards block on the drawing or model comment page of the CATIA model.
- meet Chrysler's requirements relative to regulated substances and recyclability. Products furnished to Chrysler Corporation or its subsidiaries and products and processes used by suppliers to manufacture those products must conform to the requirements in CS-9003.
- date code shielded parts, refer to PS-4480.
- mark plastic parts with the plastic Standard Marking Symbol as described in PS-4480.

All changes must meet the requirements in paragraph 11.0.



## 9.0 START OF PRODUCTION TOOLING

Upon concurrence of the Product Development Team that tooling may begin, Supplier Management will notify the supplier. The supplier is not to begin actual tooling until authorized by the Supplier Management representative either by:

- a Tooling Purchase Order
- direct communication, such as an "OK TO TOOL AUTHORIZATION NOTICE."

Refer to the "OK to Tool" Authorization Notice Operating Process booklet.

## 10.0 CONSTRUCTION AND CERTIFICATION OF TOOLING AIDS

Tooling aid(s) requirements should be specified in the quote package. Suppliers or their agents are to certify the accuracy of the specified tooling aid(s).

## 11.0 CONTROL OF CHANGES

### 11.1 Authorization

Changes affecting parts, designs, standards, materials, processes, subsources, or program requirements including performance, assembly, quality, timing, durability, warranty, service, compliance with governmental regulations, or customer satisfaction must be authorized by Chrysler.

- A. **No change shall be made by the supplier without prior approval by Chrysler.**
- B. Supplier may request a change to a part by submitting either a completed:
- "Supplier Request for Product Change" (SRPC). Refer to the Glossary.
  - "Chrysler Change to Supplier 'Odd Box' Item" (formerly known as the "Black Box Form")
- C. Any change to the end item made after award of business:
1. must be authorized and documented on the appropriate Chrysler change document. Refer to the Glossary.
  2. requires Engineering to forward a copy of the change document along with appropriate supporting documentation to Procurement and Supply.
- D. Suppliers will be required to respond promptly to a change document with cost, timing, and weight impact as requested. Chrysler Corporation will not be responsible for additional cost of supplier-initiated changes unless approved by Chrysler Engineering and Supplier Management, prior to the supplier making the change. The Product Development Team shall review the cost impact of the proposed changes. Disagreements regarding costs are to be resolved by the Supplier Management representative.

### 11.2 Drawings/CATIA Models

As each change occurs, the supplier must:

- submit updated drawings/CATIA models to Engineering.
- show the authorizing change document in the change block or CATIA model comment page.



If the change is 35 weeks prior to launch or later, the supplier must also notify Service Parts Analysis. Changes to released drawings must follow Chrysler drawing practices.

**NOTE**

Changes to supplier drawings/CATIA models or supplier specifications (standards) must follow either Chrysler or ANSI practices.

**11.3 Supplier Specifications (Standards)**

If an authorized change affects the supplier's internal specifications (standards), the supplier must submit copies of the revised document to Engineering; and if the change is 35 weeks prior to launch or later, the supplier must also notify Service Parts Analysis.

**11.4 Changes of Second Tier Sources**

The primary supplier, using the form "Chrysler Change to Supplier 'Odd Box' Item", shall notify Engineering, Procurement and Supply, and Service Parts Analysis when a change of sub-sources is being contemplated, whether or not the source is included on an Engineering Approved Source List.

**11.5 Safety, Regulatory, Regulated Substances, Recyclability, and Export Compliance**

Any running change to the design after compliance validation, must be evaluated for compliance implications. If compliance with a government regulation is affected, re-certification will be required:

- for safety and/or regulatory concerns, Engineering must notify Safety Programs. In addition, a supplemental compliance report may be required.
- for export approval, Engineering must notify the Vehicle Engineering Homologation Department to arrange for export re-certification; refer to PS-9336.
- for approval of restricted or regulated substances, the supplier must submit a revised "Supplier Regulated Substance and Recyclability Certification Report;" refer to CS-9003.
- to report changes in recyclability, the supplier must submit a revised "Supplier Regulated Substance and Recyclability Certification Report;" refer to CS-9003.

**11.6 Production Part Approval**

Refer to paragraph 13.3.

**12.0 RECORD RETENTION \***

Engineering shall maintain drawings/CATIA models and supplier specifications including all changes per the requirements in Engineering Operations Bulletins 92-1, "Record Retention Requirements" and in \*\*\* "Corporate Procedure ADM 062, "Records Management." \*\*\*

**13.0 QUALITY ASSURANCE**

**13.1 Design Verification**

As depicted in the Chrysler Performance Standard or quote package, suppliers shall furnish sample pre-production parts along with a completed "Pre-production Sample Report" to Engineering.



### 13.2 Production Validation

The supplier shall conduct Production Validation as specified in the applicable Performance Standard.

#### NOTES

Design Verification and Production Validation must be completed prior to the Process Signoff and the Production Part Approval Process Warrant submission. Successful completion of Design Verification and Production Validation does not fulfill production quality control requirements.

Any Changes (including changes to subsources, materials, processes, etc.) may require repeating Design Verification and/or Production Validation at the discretion of Engineering or Supplier Development.

### 13.3 Production Part Approval Process (PPAP)

Production Part Approval Process describes production part review and approval prior to the first quantity shipment to a Chrysler plant. The Production Part Approval Process determines if all the engineering requirements are properly understood and if the process has the potential to produce parts meeting requirements. PPAP must be successfully completed before a supplier ships the first quantity shipment to a Chrysler facility. Refer to the Glossary for further information.

Supplier submission requirements to the respective Chrysler facilities for PPAP are shown below:

- Vehicle Assembly Plants

Self-certified suppliers of end-items to Chrysler vehicle assembly plants must submit a Warrant to Chrysler's Supplier Quality LAB. Suppliers who are not classified as self-certified must submit their parts to an independent laboratory approved by Chrysler for tests and dimensional inspections, prior to submitting their Warrant to the Supplier Quality Lab.

- Chrysler Manufacturing Plants (Powertrain, Acustar, etc)

Self-certified suppliers of end-items to Chrysler plants other than assembly plants must submit a Warrant to the respective Chrysler manufacturing plant. Suppliers who are not classified as self-certified must submit along with the Warrant, sample parts and test and dimension inspection results to the Chrysler manufacturing plant.

When materials, subsources, processes, specifications, etc. for parts are changed, the supplier must repeat the production part approval process unless Engineering has waived this requirement for this specific change. Refer to AIAG's Production Part Approval Process manual and to paragraph 11.0.

For further instructions contact the responsible Supplier Management representative.

### 13.4 Continuing Conformance Requirements

Upon satisfactory completion of the requirements in paragraphs 13.1 through 13.3, the supplier must conduct Continuing Conformance Inspection/Tests as defined in the applicable Performance Standard. Shipments of parts for production and for Mopar Parts Division must conform to all specified requirements.



### 13.5 Supplier's Quality System Requirements

Suppliers must have a quality system plan to assure that only defect free parts are shipped to Chrysler. Suppliers must adhere to the current Chrysler quality system requirements.

### 14.0 WARRANTY RESPONSIBILITIES

#### 14.1 Production Items and Systems

Warranty cost reduction/elimination is the joint responsibility of Chrysler Corporation and the supplier. Chrysler Corporation has overall system responsibility to ensure that the system operation does not cause a supplier component failure. The supplier has total responsibility for the quality and reliability of the components supplied and will be held accountable for any system failures attributable to failure of the supplier's components. Such responsibility will include:

- reimbursement of Chrysler's total actual costs in extending a warranty on the supplied component, including but not limited to Chrysler's total reimbursement to its dealers for parts and labor.
- defending and indemnifying Chrysler Corporation against all claims, liabilities, losses, consequential and other damages, and settlement expenses for injury or death of any person and damage or loss of any property allegedly or actually resulting from failure of the supplier's components.

#### 14.2 Service Items

Supplier has responsibility for Service Part Warranty. This warranty will cover failures of supplied components sold by Chrysler dealers to customers outside of the new vehicle warranty.

### 15.0 SERVICEABILITY AND SERVICE PARTS REQUIREMENTS

Service information is the joint responsibility of Chrysler Corporation and the supplier. Decisions regarding how to provide service parts are the responsibility of the Supplier, Engineering, and Service Parts Analysis.

The supplier in conjunction with Engineering must design production parts, kits, and service assemblies that:

- incorporate serviceability design objectives.
- meet MOPAR parts supply needs and design objectives.
- require the minimum of special tools.
- consider low volume service production requirements.

Suppliers must provide:

- serviceability information.
- Mopar Parts, including Cataloging, Service Parts Analysis, and Tool Engineering with drawings/CATIA models, material and process specifications, graphic illustrations, or actual sample part assemblies.
- Service Parts (MOPAR) Purchasing and Service Parts Analysis approximately 35 weeks before volume production with a priced bill of material, in a structured format indicating recommended serviceable parts. The bill of material should also identify second and third tier sources.

- assurance (guarantee) that service assemblies and components are available for the entire service retention period.

Changes affecting service parts shall be handled according to the instructions in paragraph 11.0, as appropriate.

#### 16.0 CONTROL

This standard was issued by Chrysler's Engineering Standards and Information Services Department. All proposed changes should be directed to them for approval, prior to implementation.

This standard was revised through the efforts of a task force, consisting of representatives from Supplier Development, Supplier Management, Engineering Standards and Information Services, Small Car Engineering, Large Car Engineering, and MOPAR Parts Division.

#####

Subject to Protective Order - Thomas vs. DaimlerChrysler Corporation



**APPENDIX A: INTELLECTUAL PROPERTY RIGHTS, DISCLOSURE, AND NON-CONFIDENTIALITY**

**INTELLECTUAL PROPERTY RIGHTS**

Ownership of intellectual property, such as trade secrets, patents, trade marks, and copyrights, is addressed in the purchase order through rider clauses 98, 98A, and/or 99. Copies of these clauses are available from Supplier Management.

**DISCLOSURE**

Supplier at the time of preliminary discussions shall provide Engineering and Supplier Management total disclosure of supplier's patents and patent applications relating to the item to be provided by the supplier.

**NON-CONFIDENTIALITY**

It is Chrysler's policy not to enter into formal confidentiality agreements with its suppliers or potential suppliers.

Information, such as material, literature, specifications, blue-prints, CATIA models, samples, or data relating to a particular ODD Box item provided by a supplier shall not bear written "Restricted," "Confidential," or "Proprietary" notations or markings pertaining to confidential requirements or other restrictions limiting usage of the data itself or parts or processes to which it relates. Suppliers shall be asked to delete and initial any such notations, markings, or restrictions. In any event, any such notations, markings, or restrictions shall not prevent Chrysler personnel from using such information or from disclosing such information to others who have a need to know such information.

To foster the exchange of proprietary information or confidential information, Chrysler and the supplier shall rely on each other's ethics to handle each other's proprietary or confidential information in the same manner as each handles its own proprietary or confidential information. Further, the exchange of such information is with the understanding that disclosure of such information from one party to the other neither constitutes a public divulgence nor creates a bar to filing patent applications anywhere in the world.



APPENDIX B: GLOSSARY \*

AIAG. AIAG (Automotive Industry Action Group) is a trade association formed to increase productivity and competitiveness through a cooperative effort between manufacturers and suppliers.

CATIA. CATIA is the acronym for Computer Aided Three-Dimensional Interactive Application software which is used to create computer aided design models.

Change Document. Within this document, the term "change document" refers to the appropriate change instrument: Product Change Notice (PCN), Advance Product Change Notice (APCN), Change Notice (CN), Material Change Notice (MCN), Chrysler Change to an ODD Box form, SRPC, etc.

AMCN. AMCN stands for an Advance (pre-release) Material Change Notice.

APCN. An APCN (Advance Product Change Notice) communicates and coordinates part design and change information prior to release of the production drawing.

CN. A CN (Change Notice) is a streamlined version of a Product Change Notice (PCN); it automatically includes an MCN.

MCN. After release, an MCN (Material Change Notice) is the supplier's official authorization from Chrysler to implement a change in response to a product change notice (PCN). It associates costs with a PCN. (A CN encompasses an MCN and is not a separate process.)

(ODD Box form) Chrysler Change to a Supplier 'Odd Box' Item. Formerly known as a "Black Box Form" is used to request and approve changes to a drawing/CATIA model, Engineering Standard, process, material, or subsource. This form (NPM # 84-806-1609), included in the General Terms and Conditions, can be obtained from the responsible Supplier Management representative. If the change affects appearance, performance, quality, or costs, a change document may be required.

PCN. A PCN (Product Change Notice) documents, describes, and communicates a product change.

(SRPC) Supplier Request for Product Change. An SRPC (NPM # 84-806-1849) is a Chrysler form used by the supplier to obtain approval for **no-cost changes which do not affect performance, assembly, quality, durability, warranty, or customer satisfaction**. SRPCs are used for changes that will be visible on a drawing/CATIA Model. Refer to Engineering Operations Bulletin 85-5.

Design Aids. Design aids are used in developing and proving out fit, finish, and clearance among mating parts and in determining conformance to assembly, serviceability, installation, and appearance specifications.

Engineering. Within the context of this standard, the term "Engineering" denotes the lead Chrysler Vehicle Engineering design department.

Engineering Approved Source List (EASL). An Engineering Approved Source List is a list of suppliers approved by Engineering and the Procurement and Supply Office. An EASL is included as an addendum to an Engineering Standard. Refer to the Engineering Standards Writers' Guide.



ISIR/ISLR (Initial Sample Inspection Report/Initial Sample Laboratory Report). This term has been superseded by the "production part approval process." Refer to paragraph 13.3.

Outside Design and Development Item ("ODD Box"). A part, assembly, component, or vehicle sub-system designed, developed, tooled, and produced by a supplier or jointly by a supplier and Chrysler. An ODD Box may fit any of the following categories:

1. A proprietary item to which the supplier retains ownership of the intellectual property rights.
2. An adaption of the paragraph above. Modification may be made to meet Chrysler Corporation performance, identification, or packaging requirements, but the supplier retains all the intellectual property rights to the item.
3. An item designed and developed from Chrysler Corporation concepts to meet a specific need. Supplier designs and develops the item, but Chrysler Corporation owns all the intellectual property rights to the item.
4. A combination of the above items.

Pre-Production Sample Report. \* Part suppliers are required to submit a Pre-production Sample Report on pre-production parts during the program/pilot phases, prior to Production Part Approval Process Warrant submission.

Production Parts and Production Samples. Production Parts are manufactured at the production site using production tooling, gaging, processes, materials, operators, environment, and process settings, e.g. production feeds/speeds/cycle times/pressures/temperatures. Production Samples are production parts taken from a significant production run. Refer to AIAG's Production Part Approval Process manual.

Production Part Approval Process (PPAP). Production Part Approval Process is a process adopted by Chrysler, Ford, and General Motors to simplify and standardize customer (Chrysler) approval of initial samples; at Chrysler it replaces ISIR/ISLR sample submission requirements. Refer to AIAG's Production Part Approval Process Manual.

Quote Package. A collection of information which defines and explains Chrysler Corporation and supplier responsibilities and requirements. It includes information to enable the suppliers to fulfill their responsibilities and requirements. The following list depicts typical topics for a quote package and is not intended to be all inclusive:

certification requirements

- production part approval process
- Supplier Regulated Substance and Recyclability Certification Report
- tooling aids

CATIA design and transmission capabilities, in-house

documentation requirements

- drawings or CATIA models meeting Chrysler Corporation Engineering Standards
- pictorials or graphics
- supplier prints

supplier specifications (standards)

interface drawings/CATIA models

Design Verification Plan and Report (DVP & R)

FMEAs-design and process (SAE J1739, "Potential Failure Mode and Effects Analysis ....")

management approval, i.e., executive engineer's letter

milestone chart (time line)

- advanced quality plan
- applicable master timing schedule dates
- process sign-off date (process sheets, inspection instructions, gages, initial samples, and packaging)
- priority parts quality review (PPQR) dates

part name, number, and description - Chrysler (end-item)

Process Standard, PS-7000

Performance Standard for the item (including expected quality/reliability)

prototype requirements

purchase order rider clauses 98, 98A, and 99 as appropriate

recyclability requirements

sales code(s)

sample requirements (design verification, production validation, production part approval process)

standards, other applicable (Material, Process, Characteristic, etc.)

subsources (subsuppliers) if deemed necessary

serviceability and service parts requirements, refer to paragraph 15.0

target investment

target piece price

target weight

tooling aids

tooling capacity

volumes planned for each production year

Questions concerning the content of the quote package should be directed to the Supplier Management representative.

Released Drawings/CATIA models. Drawings approved by Chrysler design, Engineering, engineering management, and engineering release activities for production or special interest vehicle programs.

Special Interest Vehicle Program ("Package Program"). A program to provide special limited-volume sales models or options by modifying production vehicles prior to shipment to dealers.

Standard Parts. Parts for which specifications are published in the Standard Parts book.

Semi-Standard Parts. Parts which differ enough from Standard Parts to require their own separate drawing/CATIA model.

Supplier. The term supplier refers to both Corporate and outside sources.



**APPENDIX C. REFERENCES\***

The documents, standards, and forms referenced within this standard are listed below and are available from the organizations depicted below:

**SOURCES OF REFERENCES FOR CHRYSLER TEAM MEMBERS**

\*\*\* Corporate Process Guidelines (CPGs) (Available on HPCICS2 on Chrysler's Information Systems)

ADM057 Vehicle Safety/Emissions/Noise/Theft Regulation Compliance  
ADM062 Records Management \*\*\*

Engineering Standards and Information Services Department

Compliance Procedures <sup>1</sup>  
Diamonds-Critical Characteristics and the Pentagon-Critical Verification Symbol manuals  
Engineering Operations Bulletins:<sup>1</sup>  
85-5 "Supplier Request for Product Change (SRPC) Procedure"  
92-1 "Record Retention Requirements"  
93-1 "Homologation Requirements"  
93-2 "Entering Engineering Standard Numbers on Drawings and EBOM"  
Engineering Standards, Standards Parts book  
Engineering Standards Writers' Guide  
Engineering Standards (MS, PS, PF, CS, and AS) <sup>1</sup>  
PS-4480 "Identification of Parts"  
PS-7300 Quality Assurance Diamonds  
PS-8335 Pentagon-Critical Verification Symbol  
CS-9003 "Environmental, Health, and Occupational Safety ....  
PS-9227 "CAD/CAM Data Exchange Policy"  
PS-9336 "Homologation Requirements"  
PS-9500 "Hydrogen Embrittlement Relief"  
Chrysler safety standards, e.g. PF-SAFETY <sup>1</sup>  
Motor Vehicle Safety Standards <sup>1</sup>  
CEP-001 CAD/CAM Data Exchange Policy <sup>1</sup>  
CEP-002 Catia Standards Reference Manual <sup>1</sup>  
CEP-004 Drawing Standards Manual<sup>1</sup>  
Shields Critical Characteristics manual

Product Strategy and Regulatory Affairs Office, Vehicle Compliance and Safety Affairs Dept.  
Vehicle Components PF Safety Systems

Applicable MASSEs (Manufacturing Assurance Standard Safety/Emissions)

Safety Programs

Compliance Procedures, Reports, & Supplemental Compliance Reports  
Motor Vehicle Safety Standards and regulations

Supplier Management Organization of Procurement and Supply

Procurement and Supply Procedures ....  
Purchase Order Rider Clauses 98, 98A, and 99



Vehicle Engineering Platforms Program Management Team

"OK to Tool" Authorization Notice Operating Process

**SOURCES OF REFERENCES FOR SUPPLIERS**

Automotive Industry Action Group (AIAG)\*

\*\*\*Chrysler, Ford, and General Motors manual, Quality System Requirements QS - 9000 \*\*\*  
Production Part Approval Process

Customer Satisfaction & Vehicle Quality, Chrysler Quality Institute

Diamonds-Critical Characteristics and the Pentagon-Critical Verification Symbol manuals  
Shields Critical Characteristics manual

Engineering Standards and Information Services

CEP-001 CAD/CAM Data Exchange Policy  
CEP-002 Catia Standards Reference Manual

\*\*\* Integrated Systems Development, Holland Michigan 49422 (Phone 616-396-0880) \*\*\*

Characteristic, Material, Performance, and Process Standards  
CEP-004 Drawing Standards Manual  
Engineering Standards, Standards Parts book

Society of Automotive Engineers (SAE)

J1739, "Potential Failure Mode and Effects Analysis...."

Supplier Management Organization of Procurement and Supply

Chrysler Change to Supplier "Odd Box" Item (NPM # 84-806-1609)  
Purchase Order Rider Clauses 98, 98A, and 99  
Supplier Request for Product Change - SRPC (NPM # 84-806-1849)

---

1. Available on-line on the Automated Document Retrieval and Engineering Standards System (ADDRESS®).

**End of Strickland Document**

# Tab 6

Center for Auto Safety letter to Chrysler-Fiat Chairman Sergio Marchionne  
of November 17, 2011

-----  
Paul V. Sheridan letter of 13 February 2012 to Congressmen:

Representative Elijah Cummings  
Representative James D. Jordan  
Representative Mike Kelly  
Representative Dennis Kucinich

Subject: 1993-2004 Jeep Grand Cherokee Post-Collision Fire Death Defect Investigation  
Reference: House Oversight and Government Reform Hearing (Chevrolet Volt) of 25Jan2012

# CENTER FOR AUTO SAFETY

1825 CONNECTICUT AVENUE NW SUITE 330 WASHINGTON DC 20009-5708  
202-328-7700  www.autosafety.org

November 17, 2011

Sergio Marchionne, Chairman  
Chrysler Group LLC  
1000 Chrysler Drive  
Auburn Hills MI 48321-8004

Dear Chairman Marchionne:

On September 1, 2011, [the Center for Auto Safety \(CAS\) asked you to recall](#) all 1993-04 Jeep Grand Cherokees for fuel fed fires in rear impacts that have claimed far more lives than the infamous Ford Pinto. Just yesterday, November 16, the [Jeep Grand Cherokee claimed yet another life](#) and [severely burned another person on I4 in Orlando FL](#). If Chrysler had recalled the 1993-04 Grand Cherokee as CAS requested or as Ralph Nader requested in January 2011, the Orlando Grand Cherokee occupants would not have been burned. The tragic question is how many more fatal fire crashes will it take before Chrysler recalls this Pinto for soccer moms. The known toll now stands at 185 fatal fire crashes with 270 deaths and numerous burn injuries. At the time of its recall, NHTSA reported only 28 deaths in fire crashes of Ford Pintos.

[Chrysler responded to CAS' request to recall the Grand Cherokee](#) and save lives with a letter long on rhetoric and short on facts from Chrysler's recall manager. (See attachment A.) Nowhere does Chrysler address the fact that NHTSA FARS data show the Grand Cherokee has a fatal rear impact fire death rate 20 times higher than the Ford Explorer. Nowhere does Chrysler address the fact that crash tests done by FHWA and CAS show the Grand Cherokee suffered catastrophic fuel system failures at energy levels both significantly below and slightly above present FMVSS 301 levels. Nowhere does Chrysler address the fact the 70 mph FHWA crash test on a Ford Explorer had an energy level nearly twice that of FMVSS 301 and suffered no breach of the fuel system. (See Table below.)

| Test              | Impactor          | Impactor Weight | Impactor Speed | Crash Energy  |
|-------------------|-------------------|-----------------|----------------|---------------|
| old FMVSS 301     | flat face barrier | 4,000 pounds    | 30 mph         | 121,000 lb-ft |
| new FMVSS 301     | contoured barrier | 3,015 pounds    | 50 mph         | 253,000 lb-ft |
| FHWA Explorer     | 2003 Taurus sedan | 3,110 pounds    | 68 mph         | 483,000 lb-ft |
| FHWA Grand Cher.  | 2000 Taurus SW    | 3,296 pounds    | 49.7 mph       | 274,000 lb-ft |
| First Karco test  | 1987 Taurus sedan | 3,387 pounds    | 51.4 mph       | 301,000 lb-ft |
| Second Karco test | 1988 Taurus sedan | 3,364 pounds    | 40.7 mph       | 187,000 lb-ft |

Chrysler's failure to respond to CAS' request to recall the Grand Cherokee and save lives is inexplicable other than as a defensive tactic in view of the cooperative relationship between Chrysler and CAS in the past. In 1992, [CAS conducted an independent crash test of a 1993 Chrysler L/H sedan provided by Chrysler](#) at a DOT approved test facility. (Attachment B.) If



Chrysler accepted our crash test then, why not accept our crash tests now, all done at DOT approved facilities.

In December 1990 CAS asked then Chrysler CEO Lee Iacocca to take responsibility for A-604 Ultradrive transmission failures by redesigning it and helping consumers who had already bought one of these lemons. In response Mr. Iacocca personally came to Washington to meet with CAS. Chrysler Vice President Theodore Cunningham made specific, public promises from Chrysler to repair all Ultradrive transmissions, waive the \$100 deductible in the warranty, provide loaners, buy back any 1989-91 models with Ultradrives that could not be fixed and to improve the quality of the Ultradrive in future models. At the same [Chrysler invited CAS Executive Director Clarence Ditlow to make a presentation](#) to Chrysler's Board of Directors on safety and consumer issues. (Attachment C.)

Our September 1, 2011 letter to you said: "As the CEO of the new Chrysler Group LLC who has spoken out about the social responsibility of leaders not to close their eyes to problems but to find solutions, the Center for Auto Safety and the families of victims call on you to recall all 1993-04 Jeep Grand Cherokees and remedy the defects in their fuel systems so this defect does not claim any more victims." The Orlando Grand Cherokee crash on November 16 shows our prediction was correct. How many more people will be killed and tragically burned in Grand Cherokee fire crashes before Chrysler agrees to a recall? As outlined by Ralph Nader to Fiat Chief Engineer Harald Wester in Milano, Italy on January 26, the recall remedy is simple and inexpensive.

*Just like Ford recalled the Pinto, Fiat needs to recall the Grand Cherokee and remedy the fuel tank defect by installing (1) an optional frame rail reinforcement bracket on the 1993-1998 Grand Cherokee, (2) optional skid plates on all 1993-2004 Grand Cherokees that do not have them, (3) an effective check valve system to shut off the flow of gasoline if the filler hose is pulled out of the fuel tank or filler neck, and (4) additional shields to protect the fuel tank from sharp objects in the crush zone impacts. To ensure these inexpensive remedies are adequate, Fiat should conduct a public crash test program just as was done for the Ford Pinto recall.*

Once again, the Center for Auto Safety asks you as Chrysler's CEO to do the right thing and recall the 1993-2004 Jeep Grand Cherokee.

Sincerely,



Clarence Ditlow  
Executive Director

# Tab 7

Paul V. Sheridan letter to Mr. David Strickland of December 5, 2011

-----  
Paul V. Sheridan letter of 13 February 2012 to Congressmen:

Representative Elijah Cummings  
Representative James D. Jordan  
Representative Mike Kelly  
Representative Dennis Kucinich

Subject: 1993-2004 Jeep Grand Cherokee Post-Collision Fire Death Defect Investigation  
Reference: House Oversight and Government Reform Hearing (Chevrolet Volt) of 25Jan2012



FedEx Express  
Customer Support Trace  
3875 Airways Boulevard  
Module H, 4th Floor  
Memphis, TN 38116

U.S. Mail: PO Box 727  
Memphis, TN 38194-4643  
Telephone: 901-369-3600

December 6, 2011

Dear Customer:

The following is the proof-of-delivery for tracking number **869667283768**.

---

**Delivery Information:**

---

|                       |                   |                           |                                   |
|-----------------------|-------------------|---------------------------|-----------------------------------|
| <b>Status:</b>        | Delivered         | <b>Delivered to:</b>      | Receptionist/Front Desk           |
| <b>Signed for by:</b> | T.MAPP            | <b>Delivery location:</b> | 1200 N.J. AVE SE W41 306<br>20590 |
| <b>Service type:</b>  | Standard Envelope | <b>Delivery date:</b>     | Dec 6, 2011 11:19                 |

---

**Shipping Information:**

---

|                         |              |                   |                |
|-------------------------|--------------|-------------------|----------------|
| <b>Tracking number:</b> | 869667283768 | <b>Ship date:</b> | Dec 5, 2011    |
|                         |              | <b>Weight:</b>    | 0.5 lbs/0.2 kg |

**Recipient:**  
MR DAVID STRICLAND  
NHTSA HEADVEATERS  
1200 NEW JERSEY AVE SE  
20590 US

**Shipper:**  
PAUL SHERIDAN  
SHERIDAN, PAUL V  
22357 COLUMBIA ST  
481243431 US

**Reference**

PE 10031

Thank you for choosing FedEx Express.

FedEx Worldwide Customer Service  
1.800.GoFedEx 1.800.463.3339

To: Mr. David L. Strickland \*  
NHTSA Headquarters  
West Building  
1200 New Jersey Avenue, SE  
Washington, DC 20590  
888-327-4236

Date: 5 December 2011

VIA FEDEX [8696 6728 3768](tel:869667283768)

From: Mr. Paul V. Sheridan  
DDM Consultants  
22357 Columbia Street  
Dearborn, MI 48124-3431  
313-277-5095  
[pvs6@Cornell.edu](mailto:pvs6@Cornell.edu)

**Subject :** Death / Severe Injury Accident of 16 November 2011 in Orlando, Florida Involving 1997 Jeep Grand Cherokee (ZJ-Body)

**References :** (1) NHTSA Action Number PE10031 – File Update (Jeep Grand Cherokee Fuel System Crashworthiness Defect Investigation)

(2) My Letter to You, Dr. Dieter Zetsche, et al. of 9 February 2011

### Courtesy Copy List

Ms. Angel M. DeFilippo \*\*  
Grieco Oates & DeFilippo, LLC  
414 Eagle Rock Avenue  
West Orange, NJ 07052  
973-243-2099

Mr. Courtney E. Morgan, Jr. \*\*  
Morgan & Meyers, PLLC / Suite 320  
3200 Greenfield Road  
Dearborn, MI 48120  
313-961-0130

Mr. Clarence Ditlow, Director \*\*  
Center for Auto Safety - Suite 330  
1825 Connecticut Ave, NW  
Washington, DC 20009-5708  
(202) 328-7700

Senator John Rockefeller IV \*\*  
Commerce, Science and Transportation Committee  
531 Hart Senate Office Building  
Washington, DC 20510  
(202) 224-6472

Dr. Dieter Zetsche \*\*\*  
Chairman of the Board of Management  
Daimler AG  
Corporate Headquarters  
Mercedesstr. 137  
70327 Stuttgart, Germany  
011-49-711-17-0

Mr. Richard D. Lawrence, P.E. \*\*  
Crash Data Research Center  
Calspan Corporation  
4455 Genesee Street  
Buffalo, NY 14225  
716-631-6988

\* Available with hyperlinks here: <http://links.veronicachapman.com/Sheridan2Strickland-3.pdf>

\*\* By email

\*\*\* Via FedEx 8327 2778 7986



DDM Consultants  
22357 Columbia Street  
Dearborn, MI 48124-3431  
313-277-5095

5 December 2011

VIA FEDEX AIRBILL # [8696 6728 3768](#)

Mr. David L. Strickland, Administrator  
NHTSA Headquarters  
1200 New Jersey Avenue, SE  
Washington, DC 20590  
888-327-4236

**Subject :**               **Death / Severe Injury Accident of 16 November 2011 in Orlando, Florida  
Involving 1997 Jeep Grand Cherokee (ZJ-Body)**

**References :**           **(1) NHTSA Action Number PE10031 – File Update (Jeep Grand Cherokee  
Fuel System Crashworthiness Defect Investigation)**

**(2) My Letter to You, Dr. Dieter Zetsche, et al. of 9 February 2011**

Dear Mr. Strickland:

I am confident that you have been informed of the subject accident.

I have just returned from Orlando, Florida where I examined and photographed the subject vehicle, a 1997 Jeep Grand Cherokee (VIN: 1J4FX58SXVC691465). My preliminary examination included discovery of the following salient physical facts relating to this vehicle/accident:

1. Did not have a trailer tow hitch device,
2. Did not have a “brush guard” device mounted near or upon the rear-mounted fuel tank,
3. Did not have a skid plate encapsulating the rear-mounted fuel tank,
4. Did include a left-side rear frame “reinforcing bracket”; a device that was not included in pre-1997 ZJ-Body vehicles (or any other vehicle that I am familiar with),
5. A majority of the collision crush/intrusion occurred on the passenger/right side of the vehicle,
6. The driver/left side of the vehicle displayed a crush dimension that would not have impacted a left-side mid-mounted fuel tank, such as that offered beginning with the 2005 WK-Body version of the Jeep Grand Cherokee, then originally offered by DaimlerChrysler.

Most importantly, it is also clear from this preliminary physical examination, as well as discussions that I have had with both the Florida Highway Patrol and the technicians at Cortes Towing Service, that the two victims in the subject vehicle survived the collision event. Indeed, not only were both victims conscious post-collision, but the non-fire related driver injuries (if any) were so minor that he was observed escaping from the driver’s compartment, while on-fire, under his own physical ability. If there is any doubt on this point, please review <http://www.youtube.com/watch?v=gQp6MG7w--s>, while listening carefully to 1:20 and again beginning at 1:50.

Specifically, the horrific death and injury inflicted upon the two victims occurred as a direct result of the breach of the defective rear-mounted unprotected ZJ-Body fuel tank system.

**Reference 2 : My Letter to You, Dr. Dieter Zetsche, et al. of 9 February 2011**

As of the date above I have not received a response or NHTSA action on my letter of 9 February 2011. In the context of physical fact #6, I am reiterating 'Concern 3' from that letter, in its entirety, which stated:

*"I was shocked to learn that only four original equipment manufacturers (OEM) were solicited for comment under PE10031. The most relevant OEM was not included: Daimler AG. This error is serious.*

*The 1993 ZJ-Body formed the engineering basis of the 1999 to 2004 WJ-Body Jeep Grand Cherokee. However, the WJ-Body was tooled prior to the 1998 "merger" of Daimler-Benz and Chrysler. This timing obviated the feasibility that the fuel system crashworthiness defect issue could be rectified by Daimler-Benz engineers. The WK-Body program was approved by post-merger DaimlerChrysler in late 2000.*

*The earliest post-merger timing which allowed for Daimler-Benz engineering design practices to correct the original fuel system crashworthiness defect issue of the ZJ-Body occurred with the 2005 WK-Body. At the time of the "merger," it was recognized that none of the decades-old Mercedes-Benz SUV vehicles located an unprotected fuel tank behind the rear axle and below the bumper. Mercedes-Benz M-Class SUVs are well-known examples. Daimler-Benz engineering design inputs and commonized components with the Grand Cherokee are also boasted in Jeep [media reviews](#) and technical journals.*

*NHTSA data confirms that since introduction of the Daimler-Benz influenced WK-Body, no fuel system related deaths have occurred. In my opinion, this is typical of the results we can expect from a "real world" approach to engineering design. It is well-known that the 2005 WK-Body and 2011 WL-Body Jeep Grand Cherokee fuel system design occurred as a direct result of Daimler influence. On this basis alone it is a serious error, if not an outright breach of the public trust, that PE10031 has not yet solicited the comments of the very managerial and engineering personnel who are directly responsible for this laudable real world 'zero deaths' statistic. "*

Also included in my letter to you of 9 February 2011 were the following four requests:

**1) I hereby request that NHTSA PE10031 openly solicit comments from Daimler AG.\* 2) Please update the PE10031 file to correctly reflect Fiat S.p.A. as the "manufacturer" of the 1993 to 1998 ZJ-Body and the 1999 to 2004 WJ-Body Jeep Grand Cherokee vehicles. 3) Please add this letter and all enclosures to the PE10031 public file. 4) Please feel free to contact me at any time.**

My cover letter (only) of 9 February 2011 is enclosed as Attachment 1 for your current reference.

\* Bolding added.

### **Update**

As you are aware, Mr. Richard D. Lawrence of Calspan Corporation, under contract with NHTSA, has made contact with the Florida Highway Patrol and the staff/owner at Cortes Towing of Longwood, Florida (the current storage location of the subject vehicle) for the purposes of arranging an inspection, presumably, similar to mine of last Thursday, 1 December 2011. I emphasize 'similar to mine' in view of the historical fact that spoliation of these accident vehicles has occurred via defense experts in other existing death case litigation. I emphasize 'similar to mine' relating to the fact that, consistent with my standard practices and expertise, the subject vehicle was not touched, merely photographed (a sampling of the latter is enclosed as Attachment 2). It is my understanding that Mr. Lawrence is scheduling a subject vehicle examination for the week of 12December2011.

### **Conclusion**

I am attaching for inclusion in the NHTSA PE10031 file the FedEx SPOD for the courtesy copy to Dr. Dieter Zetsche of my 9 February 2011 letter, which was signed by Daimler AG staff upon its arrival in Stuttgart, Germany on 16February2011 (Attachment 3).

Most importantly, in light of the subject accident of 16 November 2011, my preliminary examination of the subject vehicle on 1 December 2011, and physical fact #6, I reiterate my request of 9February2011 "*that NHTSA PE10031 openly solicit comments from Daimler AG*" per the ordinary and customary NHTSA investigation procedures, but also regarding their reasons for revising the 2005 Jeep Grand Cherokee WK-Body fuel system design to that very similar to pre-existing and then-existing Mercedes-Benz SUVs.

Respectfully yours,

Paul V. Sheridan

Attachments

# Attachment 1



To: Mr. David L. Strickland \*  
NHTSA Headquarters  
West Building  
1200 New Jersey Avenue, SE  
Washington, DC 20590  
888-327-4236

Date: 9 February 2011

[VIA FEDEX 8696-6728-3908](#)

From: Mr. Paul V. Sheridan  
DDM Consultants  
22357 Columbia Street  
Dearborn, MI 48124-3431  
313-277-5095  
[pvs6@Cornell.edu](mailto:pvs6@Cornell.edu)

**Reference : NHTSA Action Number PE10031 – File Update  
(Jeep Grand Cherokee Fuel System Crashworthiness Defect Investigation)**

### Courtesy Copy List

Ms. Angel M. DeFilippo \*\*  
Grieco Oates & DeFilippo, LLC  
414 Eagle Rock Avenue  
West Orange, NJ 07052  
973-243-2099

Mr. Courtney E. Morgan, Jr. \*\*  
Morgan & Meyers, PLLC / Suite 320  
3200 Greenfield Road  
Dearborn, MI 48120  
313-961-0130

Mr. Clarence Ditlow, Director \*\*  
Center for Auto Safety  
Suite 330  
1825 Connecticut Ave, NW  
Washington, DC 20009-5708  
(202) 328-7700

Senator John Rockefeller IV \*\*\*  
Commerce, Science and Transportation Committee  
531 Hart Senate Office Building  
Washington, DC 20510  
(202) 224-6472

Dr. Dieter Zetsche \*\*\*\*  
Chairman of the Board of Management  
Daimler AG  
Corporate Headquarters  
Mercedesstr. 137  
70327 Stuttgart, Germany  
011-49-711-17-0

Mr. Lawrence Hershman \*\*  
NHTSA Headquarters  
West Building  
1200 New Jersey Avenue, SE  
Washington, DC 20590  
888-327-4236

\* Available with hyperlinks here: <http://links.veronicachapman.com/Sheridan2Strickland-1.pdf>

\*\* By email.

\*\*\* Via FedEx [8696-6728-3919](#)

\*\*\*\* Via FedEx [7944-2034-9759](#)

DDM Consultants  
22357 Columbia Street  
Dearborn, MI 48124-3431  
313-277-5095

9 February 2011

[VIA FEDEX AIRBILL # 8696-6728-3908](#)

Mr. David L. Strickland, Administrator  
NHTSA Headquarters  
1200 New Jersey Avenue, SE  
Washington, DC 20590  
888-327-4236

**Reference : NHTSA Action Number PE10031 – File Update  
(Jeep Grand Cherokee Fuel System Crashworthiness Defect Investigation)**

Dear Mr. Strickland:

I am writing to share with you my perspective, and the concerns I have regarding PE10031. These are qualified by experience-with and ongoing knowledge-of the defect investigation process/history of the National Highway Traffic Safety Administration (NHTSA).<sup>A</sup> My perspective is partially documented by the enclosures. My concerns and related requests relative to the reference are also offered.

### **Enclosure 1**

*My Letter/Binder of 27 October 1999 to Attorney General Janet Reno, Subject: Department of Justice Assistance to Special Interests – Chrysler Corporation: FOIA Lawsuits and the NHTSA Defect Investigation Conspiracy*

The setting of this enclosure is a defect investigation (EA94-005) conducted by NHTSA regarding a safety standard that was deemed ineffective in the real world. FMVSS-206 did not and could not protect occupants during minor collisions in minivans. Enclosure 1 documents NHTSA cooperation with Chrysler Corporation which ensured that crash test results would not be made public under the ruse of an “ongoing investigation” (which in-truth had concluded during a secret NHTSA/Chrysler meeting of November 17, 1994).<sup>B</sup> I also detail the number of injuries/fatalities that were inflicted upon minivan passengers during NHTSA’s “ongoing investigation.” The essence of the ruse, and confirmation of the agency’s direct participation, is presented under the colored tab. Please note that former Chrysler Vice Chairman Robert A. Lutz and former Chrysler Chairman Robert J. Eaton both confirmed these basic facts while under-oath.

During the NHTSA/Chrysler ruse, I was [falsely accused of wrong-doing](#) by Chrysler defense attorneys, fired on that basis during Christmas holidays, and sued in a Michigan court session, *all ex parte*, in late December 1994. However, completely unaware of NHTSA’s conduct and perhaps naively, it was during this period that I was attempting to inform the agency of my concerns regarding the very same “safety defect” that was secretly presented/quoted as-such to Chrysler.<sup>C</sup>

**Enclosure 2**

*Gala reception invitation of March 2002, provided by Washington-based product liability defense firm Hogan & Hartson L.L.P., held for former Chrysler product liability defense lawyer, and then recently appointed Chief Counsel of NHTSA, Ms. Jacqueline Glassman.*

The taxpayer is not aware of the practice of selected NHTSA officials attending gala celebrations which are funded by auto companies and/or their defense counsel. Given that influence-upon or corruption-of the overall regulatory process by special interests remains a major political/social issue, it is reasonable for the taxpayer to assume that their real world safety interests are not prioritized. <sup>D</sup>

To the best of my knowledge no plaintiffs or plaintiffs' law firms have offered or funded similar galas for high-level NHTSA officials. To the best of my knowledge no auto company, other than Chrysler/DaimlerChrysler, has offered and funded a similar gala for a high-level NHTSA official. <sup>E</sup>

**Enclosure 3**

*Eight-minute excerpt (DVD) of deposition testimony of former Chrysler Executive Vice President of Engineering and Jeep Products Executive, Mr. Francois J. Castaing, in the Jeep crashworthiness litigation of Tenaglia versus Chrysler Corporation, March 14, 1996.*

Chrysler Corporation acquired American Motors in 1987. The specific theme of that transaction, per Chairman Lee A. Iacocca, was acquisition of the Jeep product line. Executive management approved the new Jeep Grand Cherokee program (ZJ-Body), with a planned introduction for model-year 1993. <sup>F</sup>

In September 1987 I was promoted from Dodge Truck Operations into Jeep & Truck Engineering (JTE). I worked at JTE until January 1991 when I was assigned to Minivan Operations. During this four-year period I attended, as participant and presenter, numerous 'Engineering Program Review' meetings (EPR) where both Dodge truck and Jeep products were discussed. EPRs were held by direction-of JTE Vice President, Mr. Francois Castaing. He later assumed the position of Executive Vice President of Engineering, and became the Jeep Products Executive. <sup>G</sup> As Executive VP of Engineering, Mr. Castaing was also a key participant in the discussions of Enclosure 1. <sup>H</sup>

Enclosure 3 highlights examination by plaintiff attorney Mr. Larry Coben regarding Mr. Castaing's engineering knowledge of Jeep product crashworthiness:

*Coben: What does the term crashworthiness mean in terms of design of a product?*

*Castaing: I don't know. Tell me.*

*Coben: You don't know the phrase?!*

*Castaing: No.*

*Coben: Well, let me make sure I'm clear on this. As the chief engineer of the company, are you at all familiar with the use of the phrase crashworthiness by the engineers of the company?*

*Castaing: Crashworthiness is so vague that you have to tell me what you intend by that.*

It should be emphasized that by the time of [this sworn testimony](#) Mr. Castaing was Executive Vice President of Engineering, and Product Executive responsible for all aspects of the Jeep product. Enclosure 3 should be viewed in the context of its historical and general implications for PE10031.

### Concern 1

During our introduction at the Russell Senate Office Building in May 2010, prior to your testimony before Senate Commerce Chairman John Rockefeller, I discussed and you cordially agreed to receive documents that would assist NHTSA with DP09005. Of particular interest/relevance was the internal Chrysler letter referred to as the "Baker memo." This August 24, 1978 memo states in-part:

*"Chrysler is investigating fuel tank relocation ahead of the rear wheels for vans and multipurpose vehicles, but present plans for pickups through 1983 and for MPV's and vans through 1985 have the fuel tank located behind the rear wheels. In vehicles both with and without bumpers there is a concern with vertical height differences that create a mismatch with passenger car bumpers. Where fuel tank location behind the rear axle is all that is feasible, a protective impact deflection structure may have to be provided whether or not a bumper is provided. An investigation whether to relocate the fuel tank or to provide impact deflecting structures is presently underway."*

I had forwarded this material under cover of 1 June 2010 to Mr. Clarence Ditlow, Director at the Center for Auto Safety (CAS). This material was received by your office on 4 June 2010. My concern involves the fact that this material was only-recently entered into the public file, and only at the prompting of Mr. Ditlow. I am unsure why this part of the investigation process took nearly one year (Enclosure 4).

### Concern 2

Although I agree with your decision to elevate DP09005 to the referenced preliminary evaluation, I am concerned with some historically familiar NHTSA rhetoric. Upon opening a defect investigation NHTSA typically pursues "preliminary examination of available data."

In contrast, as chairman of the Chrysler Safety Leadership Team (SLT), my priority involved Failure Mode Effects Analysis (FMEA) as the basis of preliminary and ongoing examination of a safety concern. In my role it did not matter that only one person may be affected during vehicle service life. What mattered was that a failure mode existed, and when provoked would cause serious harm. Hypothetically, the fact that a vehicle service life was statistically "lucky," and a failure mode was provoked "only once," was not gala. Such an approach would merely confirm incompetence as a safety manager. <sup>I</sup>

For perspective, I have testified in litigation wherein defense counsel has deployed two themes: 1) "compliance with all government safety standards" and 2) various NHTSA statistics. However, when the jury in Jimenez v Chrysler learned of the latter's foreknowledge that FMVSS-206 failed to address the failure mode that was responsible for the death of an 8-year-old boy, that standard and related NHTSA statistics were rendered legally and morally worthless. <sup>J</sup> Similarly, when the jury in Flax v Chrysler learned that FMVSS-207 did not address the failure mode that was responsible for the death of an infant, that standard and related statistics were deemed irrelevant. <sup>K</sup>

Regarding PE10031, it appears that NHTSA is evoking FMVSS-301 and various statistics. It further appears that the agency is misrepresenting the FMEA in question when it declares that CAS has "defined . . . vehicle being struck at the 5, 6 or 7 o'clock positions." This error needs to be clarified. A central part of the FMEA that we have long-defined, and one that FMVSS-301 has never addressed, is the issue of collision override: Specifically, this failure mode involves direct collision impact with the unprotected Jeep Grand Cherokee fuel tank and associated components. In no uncertain terms, and despite compliance with FMVSS-301, the "Baker memo" confirms Chrysler foreknowledge of this direct collision impact issue via its "impact deflection structure" and "vertical height differences" verbiage. <sup>L</sup>



### Concern 3

I was shocked to learn that only four original equipment manufacturers (OEM) were solicited for comment under PE10031. The most relevant OEM was not included: Daimler AG. This error is serious.

The 1993 ZJ-Body formed the engineering basis of the 1999 to 2004 WJ-Body Jeep Grand Cherokee.<sup>M</sup> However, the WJ-Body was tooled prior to the 1998 “merger” of Daimler-Benz and Chrysler. This timing obviated the feasibility that the fuel system crashworthiness defect issue could be rectified by Daimler-Benz engineers. The WK-Body program was approved by post-merger DaimlerChrysler in late 2000.

The earliest post-merger timing which allowed for Daimler-Benz engineering design practices to correct the original fuel system crashworthiness defect issue of the ZJ-Body occurred with the 2005 WK-Body. At the time of the “merger,” it was recognized that none of the decades-old Mercedes-Benz SUV vehicles located an unprotected fuel tank behind the rear axle and below the bumper.<sup>N</sup> Mercedes-Benz M-Class SUVs are well-known examples. Daimler-Benz engineering design inputs and commonized components with the Grand Cherokee are also boasted in Jeep [media reviews](#) and technical journals.<sup>O</sup>

NHTSA data confirms that since introduction of the Daimler-Benz influenced WK-Body, no fuel system related deaths have occurred. In my opinion, this is typical of the results we can expect from a “real world” approach to engineering design. It is well-known that the 2005 WK-Body and 2011 WL-Body Jeep Grand Cherokee fuel system design occurred as a direct result of Daimler influence. On this basis alone it is a serious error, if not an outright breach of the public trust, that PE10031 has not yet solicited the comments of the very managerial and engineering personnel who are directly responsible for this laudable real world ‘zero deaths’ statistic.

### Requests (4)

1) I hereby request that NHTSA PE10031 openly solicit comments from Daimler AG. 2) Please update the PE10031 file to correctly reflect Fiat S.p.A. as the “manufacturer” of the 1993 to 1998 ZJ-Body and the 1999 to 2004 WJ-Body Jeep Grand Cherokee vehicles. 3) Please add this letter and all enclosures to the PE10031 public file. 4) Please feel free to contact me at any time.

Respectfully yours,

Paul V. Sheridan

Enclosures (4)

## Endnotes

---

- <sup>A</sup> Some of this discussion will be new/unknown to you, and intrinsically unassociated with your good efforts.
- <sup>B</sup> Please review Tab 4 of Enclosure 1.
- <sup>C</sup> Please review Tabs 15 and 27 of Enclosure 1.
- <sup>D</sup> For an introduction to the impression my safety priorities made please see Tab 27 of Enclosure 1.
- <sup>E</sup> To the best of my knowledge Enclosure 2 was arranged in-part by former internal Chrysler Corporation lead product liability attorney Mr. Lewis H. Goldfarb (Please see Page 2-of-10 and Tab 16 of Enclosure 1).
- <sup>F</sup> Formal ZJ-Body program approval occurred at the Product Planning Committee in late 1987.
- <sup>G</sup> Please see Tab 20 of Enclosure 1.
- <sup>H</sup> Please review Tabs 14 and 16 of Enclosure 1.
- <sup>I</sup> A dramatic demonstration of the validity of the FMEA prioritization approach occurred on the morning of Tuesday, [January 28, 1986](#).
- <sup>J</sup> Please see Tab 12 of Enclosure 1.
- <sup>K</sup> Please see Page 6-of-10 and Tab 21 of Enclosure 1.
- <sup>L</sup> In at least one prior fuel system defect investigation, NHTSA has been made fully aware of the inherent dangers of direct collision impact with an unprotected fuel tank and associated components. The automotive insurance industry also recognizes the underride collision event, showing this event in several television advertisements.
- <sup>M</sup> Proclamations about the “numbers of new parts” comprising the “all new” WJ-Body in-fact relate primarily to cosmetic revisions and as-such have no relevance to the referenced discussion which focuses on the placement and resulting/ongoing defective crash performance of the ZJ/WJ fuel system.
- <sup>N</sup> During 2009, [Chrysler statements](#) alleged that the re-positioning/re-engineering of the 2005 WK-Body Jeep Grand Cherokee fuel tank (forward of the rear axle and shielded by an “impact deflecting structure) occurred to accommodate “interior luggage space.” On several levels this is absurd, especially when reviewing the well-known fact that a 1980’s version of the Jeep platform had already moved the fuel tank forward of the axle, and “interior luggage space” was not a consideration for that re-positioning. At the time of the MJ-Body, the primary justification for the re-positioning was ease of access to the spare tire.
- <sup>O</sup> Recent 2011 WL-Body Jeep Grand Cherokee television advertisements ostensibly declare the importance of “impact deflection structure,” [referred to in the ad as a skid plate](#). Such has been standard equipment on Mercedes-Benz SUV vehicles for decades.

# Attachment 2







GRAND CHEROKEE

LAREDO













# Attachment 3



FedEx Express  
Customer Support Trace  
3875 Airways Boulevard  
Module H, 4th Floor  
Memphis, TN 38116

U.S. Mail: PO Box 727  
Memphis, TN 38194-4643

Telephone: 901-369-3600

February 17, 2011

Dear Customer:

The following is the proof-of-delivery for tracking number **794420349759**.

---

**Delivery Information:**

---

|                       |              |                           |  |
|-----------------------|--------------|---------------------------|--|
| <b>Status:</b>        | Delivered    | <b>Delivered to:</b>      | Shipping/Receiving                     |
| <b>Signed for by:</b> | .GEIGER      | <b>Delivery location:</b> | 255 ULMERSTR 70327<br>STUTT GART 70327 |
| <b>Service type:</b>  | Priority Box | <b>Delivery date:</b>     | Feb 16, 2011 10:57                     |



---

**Shipping Information:**

---

|                         |              |                   |                |
|-------------------------|--------------|-------------------|----------------|
| <b>Tracking number:</b> | 794420349759 | <b>Ship date:</b> | Feb 14, 2011   |
|                         |              | <b>Weight:</b>    | 5.2 lbs/2.4 kg |

**Recipient:**  
DR. DIETER ZETSCHÉ  
DAIMLER AG  
CORPORATE HEADQUARTERS  
MERCEDSSTR 137  
STUTT GART 70327 DE

**Reference**

**Shipper:**  
PAUL SHERIDAN  
DDM  
22357 COLUMBIA STREET  
DEARBORN, MI 48124 US

NHTSA PE10-031

Thank you for choosing FedEx Express.

FedEx Worldwide Customer Service  
1.800.GoFedEx 1.800.463.3339

# Tab 8

Center for Auto Safety letter to Chrysler-Fiat Chairman Sergio Marchionne  
of January 25, 2012

-----

Paul V. Sheridan letter of 13 February 2012 to Congressmen:

Representative Elijah Cummings  
Representative James D. Jordan  
Representative Mike Kelly  
Representative Dennis Kucinich

Subject: 1993-2004 Jeep Grand Cherokee Post-Collision Fire Death Defect Investigation  
Reference: House Oversight and Government Reform Hearing (Chevrolet Volt) of 25Jan2012

---

# CENTER FOR AUTO SAFETY

1825 CONNECTICUT AVENUE NW SUITE 330 WASHINGTON DC 20009-5708  
202-328-7700 ◆ www.autosafety.org

January 25, 2012

Sergio Marchionne, Chairman  
Chrysler Group LLC  
1000 Chrysler Drive  
Auburn Hills MI 48321-8004

Dear Chairman Marchionne:

While Chrysler stonewalls a recall of 2.2 million 1993-04 Jeep Grand Cherokees, people are dying horrible deaths from fires in rear impacts and crashes that breach the exposed fuel tank behind the rear axle. [On September 1](#), we quoted you on social responsibility and asked for the recall of these Jeeps in a 397 page letter with attachments detailing the defect. On November 17, 2011, [we wrote you about a Grand Cherokee crash in Orlando](#) that claimed one life and terribly burned another victim.

The National Highway Traffic Safety Administration just released its annual FARS death report for 2010. FARS 2010 documented 14 more deaths in 13 fatal fire Jeep Grand Cherokee fire crashes with at least 6 Most Harmful Event Fire deaths. (Attachment A.) The known Jeep Grand Cherokee toll now stands at 198 fatal fire crashes with 284 deaths. (Attachment B.) At the time of its recall, NHTSA reported only 28 deaths in fire crashes of Ford Pintos.

The tragic question is how many more fatal fire crashes will it take before Chrysler recalls this Pinto for soccer moms? You yourself said: "I believe that the future is not just the responsibility of governments. It's an individual and collective responsibility. It's a challenge that calls for a concerted and shared commitment. Closing our eyes, or thinking that finding a solution is someone else's role, makes us part of the problem." How can you close your eyes to the burn deaths of so many individuals when a \$100 recall could prevent future deaths?

Your predecessor as CEO of Chrysler once said that part of his decision to install airbags at Chrysler was the prospect of St Peter at the gates of heaven asking him about airbags in cars. Just as surely, St. Peter will ask you about fuel tanks in Jeep Grand Cherokees.

Once again, the Center for Auto Safety asks you as Chrysler's CEO to do the right thing and recall the 1993-2004 Jeep Grand Cherokee.

Sincerely,



Clarence Ditlow  
Executive Director



### MY 1993-2004 Jeep Grand Cherokee Fatal Fire Crashes, 1992-2010

This table includes known fire crashes obtained from NHTSA's Fatal Analysis Crash System (FARS) for Calendar Years 1992-2010 and from public records for other years and for crashes not listed in FARS. Where FARS indicates fire is the most harmful event, that is indicated. Where FARS indicates vehicle in transport, striking tree or other object, that is indicated.

| Crash Date by State        | Name                 | City/County      | Road               | Deaths | Make/Model/Year     | FARS # |
|----------------------------|----------------------|------------------|--------------------|--------|---------------------|--------|
| <b>Connecticut</b>         |                      |                  |                    |        |                     |        |
| 02/16/10 <sup>F</sup>      | FARS                 | North Stonington | Wintechog Hill Rd. | 1      | 2004 Grand Cherokee | 90023  |
| <b>Florida</b>             |                      |                  |                    |        |                     |        |
| 10/07/10 <sup>F</sup> †(1) | FARS                 | Columbia Co.     | US-441             | 2      | 1998 Grand Cherokee | 121645 |
| 11/16/10 <sup>F-R</sup>    | Manuel Bringas-Mejia | Lake Mary        | I-4                | 1      | 1997 Grand Cherokee | N/A    |
| <b>Georgia</b>             |                      |                  |                    |        |                     |        |
| 04/29/10 <sup>F</sup>      | FARS                 | Cobb Co.         | Sewell Mill Rd.    | 1      | 2000 Grand Cherokee | 130319 |
| <b>Indiana</b>             |                      |                  |                    |        |                     |        |
| 09/18/10 <sup>F</sup>      | FARS                 | Goshen           | CR-31              | 1      | 1997 Grand Cherokee | 180537 |
| <b>Iowa</b>                |                      |                  |                    |        |                     |        |
| 09/07/01**                 | FARS (overturn)      | Patterson        | US-92              | 1      | 2001 Grand Cherokee | 190254 |
| <b>Kentucky</b>            |                      |                  |                    |        |                     |        |
| 10/12/10*                  | FARS                 | Warren Co.       | SR-101             | 1      | 1999 Grand Cherokee | 210547 |
| <b>Louisiana</b>           |                      |                  |                    |        |                     |        |
| 12/02/10*                  | FARS (overturn)      | Avoyelles Co.    | SR-453             | 1      | 1998 Grand Cherokee | 220562 |
| <b>Massachusetts</b>       |                      |                  |                    |        |                     |        |
| 03/08/10*                  | FARS (tree)          | Wareham          | I-495              | 1      | 2004 Grand Cherokee | 250027 |
| <b>New Jersey</b>          |                      |                  |                    |        |                     |        |
| 06/26/10 <sup>F</sup>      | FARS                 | Sussex Co.       | Hibler Rd.         | 1      | 1996 Grand Cherokee | 340237 |
| 09/17/10 <sup>F</sup>      | FARS                 | Holmdel          | Garden State Pkwy. | 1      | 1997 Grand Cherokee | 340416 |
| <b>North Carolina</b>      |                      |                  |                    |        |                     |        |
| 12/03/10*                  | FARS (tree)          | Edgecombe Co.    | RP-1223            | 1      | 1994 Grand Cherokee | 371134 |
| <b>Pennsylvania</b>        |                      |                  |                    |        |                     |        |
| 08/02/10*                  | FARS (tree)          | Greene Co.       | SR-1021            | 1      | 2004 Grand Cherokee | 420567 |
| <b>Texas</b>               |                      |                  |                    |        |                     |        |
| 12/31/10*                  | FARS (post)          | Anderson Co.     | FM2054             | 1      | 1999 Grand Cherokee | 482581 |

**<sup>F</sup> Indicated in FARS as most harmful: "fire/explosion."**

**\* Indicated in FARS as most harmful: "motor vehicle in transport" or "motor vehicle in transport in other roadway."**

**\*\* Item in parentheses is most harmful event as indicated in FARS.**

**<sup>F-A</sup> Fire listed as cause of death in autopsy report or death certificate.**

**<sup>F-L</sup> Fire indicated as cause of death in litigation.**

**<sup>F-R</sup> Fire indicated as cause of death in accident report.**

**† Fatality(s) (#) occurred in bullet vehicle**

### **MY 1993-2004 Jeep Grand Cherokee Fatal Fire Crashes, 1992-2010**

This table includes known fire crashes obtained from NHTSA's Fatal Analysis Crash System (FARS) for Calendar Years 1992-2010 and from public records for other years and for crashes not listed in FARS. Where FARS indicates fire is the most harmful event, that is indicated. Where FARS indicates vehicle in transport, striking tree or other object, that is indicated.

| Crash Date by State        | Name                  | City/County         | Road                      | Deaths | Make/Model/Year     | FARS # |
|----------------------------|-----------------------|---------------------|---------------------------|--------|---------------------|--------|
| <b>Alabama</b>             |                       |                     |                           |        |                     |        |
| 09/26/01**                 | FARS (overturn)       | Blount Co.          | US-SR74                   | 2      | 2000 Grand Cherokee | 10627  |
| 04/12/06 <sup>F</sup>      | FARS                  | Montgomery          | 5466                      | 1      | 2004 Grand Cherokee | 10243  |
| 04/25/07 <sup>F</sup>      | FARS                  | Macon Co.           | I-85                      | 1      | 1993 Grand Cherokee | 10270  |
| 05/20/09**                 | FARS (overturn)       | Cedar Bluff         | SR-68                     | 1      | 2002 Grand Cherokee | 10257  |
| <b>Alaska</b>              |                       |                     |                           |        |                     |        |
| 10/12/02*                  | FARS                  | Kenai Peninsula     | I-A3-2 Seward             | 2      | 2000 Grand Cherokee | 20053  |
| <b>Arizona</b>             |                       |                     |                           |        |                     |        |
| 02/01/98 <sup>F</sup>      | FARS                  | Gila Co.            | Old Dripping Springs      | 1      | 1993 Grand Cherokee | 40059  |
| 08/18/98**                 | FARS (bridge rail)    | Mohave Co.          | I-15                      | 1      | 1995 Grand Cherokee | 40506  |
| 03/13/01 <sup>F</sup>      | FARS                  | Mohave Co.          | I-40                      | 2      | 1994 Grand Cherokee | 40104  |
| 11/26/06*†(1)              | FARS                  | Surprise            | US-60 R.H. Johnson Blvd.  | 1      | 1995 Grand Cherokee | 40874  |
| 09/19/09*†(1)              | FARS                  | Tempe               | Baseline Rd. at I-10 Ramp | 1      | 2003 Grand Cherokee | 40551  |
| <b>Arkansas</b>            |                       |                     |                           |        |                     |        |
| 09/14/04*†(1)              | FARS                  | Carroll Co.         | US-62-05                  | 2      | 1999 Grand Cherokee | 50451  |
| <b>California</b>          |                       |                     |                           |        |                     |        |
| 03/06/96*†(1)              | FARS                  | Indio               | Country Club Dr.          | 2      | 1993 Grand Cherokee | 60665  |
| 03/16/96 <sup>F</sup> †(5) | FARS                  | Carson              | 91                        | 5      | 1996 Grand Cherokee | 60718  |
| 07/07/96 <sup>F</sup> †(1) | FARS                  | Poway               | Espola Rd.                | 1      | 1993 Grand Cherokee | 61698  |
| 06/14/98**†(1)             | FARS (barrier)        | Victorville         | I-15                      | 1      | 1993 Grand Cherokee | 60918  |
| 10/27/99 <sup>F</sup>      | Young Sup Lee         | Los Angeles         | SR-170                    | 1      | 1998 Grand Cherokee | 62795  |
| 05/07/00 <sup>F</sup>      | FARS                  | Orange Co.          | SR-241                    | 1      | 1993 Grand Cherokee | 60499  |
| 07/20/01 <sup>F</sup>      | FARS                  | San Bernardino Co.  | I-10                      | 1      | 1994 Grand Cherokee | 61708  |
| 08/07/01**                 | FARS (tree)           | Los Gatos           | SR-17                     | 1      | 1998 Grand Cherokee | 62067  |
| 03/23/02*†(1)              | FARS                  | Sutter Co.          | SR-99                     | 2      | 1995 Grand Cherokee | 61045  |
| 07/13/02**                 | FARS                  | San Luis Obispo Co. | Orcutt Rd.                | 1      | 2000 Grand Cherokee | 60896  |
| 08/30/02 <sup>F</sup>      | FARS                  | Bakersfield         | SR-58                     | 1      | 1993 Grand Cherokee | 62653  |
| 10/11/02**                 | FARS (overturn)       | Fresno Co.          | I-5                       | 1      | 1993 Grand Cherokee | 62779  |
| 10/04/03*                  | FARS                  | Anaheim             | S. Harbor Blvd.           | 2      | 2004 Grand Cherokee | 62897  |
| 11/27/03**                 | FARS (utility pole)   | Commerce            | Slauson Ave.              | 1      | 1996 Grand Cherokee | 63251  |
| 02/05/04*                  | FARS                  | San Bernardino Co.  | I-15                      | 1      | 1995 Grand Cherokee | 60339  |
| 05/26/04**†(2)             | FARS (overturn)       | Vacaville           | I-80                      | 4      | 2004 Grand Cherokee | 61401  |
| 06/08/04**                 | FARS (parked vehicle) | Riverside Co.       | I-10                      | 1      | 1997 Grand Cherokee | 61466  |



| Crash Date by State        | Name                 | City/County      | Road                           | Deaths | Make/Model/Year     | FARS # |
|----------------------------|----------------------|------------------|--------------------------------|--------|---------------------|--------|
| 08/18/05 <sup>F</sup>      | James Lindskog       | Oceanside        | Vista Way                      | 1      | 1994 Grand Cherokee | 63236  |
| 05/24/06 <sup>F</sup> †(1) | FARS                 | Orange Co.       | SR-241                         | 2      | 2001 Grand Cherokee | 61349  |
| 06/25/06**                 | FARS (tree)          | Sonoma Co.       | Petrified Forest Rd. Sharp Rd. | 1      | 1993 Grand Cherokee | 62934  |
| <b>Colorado</b>            |                      |                  |                                |        |                     |        |
| 07/24/94*                  | FARS                 | Denver           | Martin Luther King Blvd.       | 1      | 1994 Grand Cherokee | 80258  |
| 09/02/02**                 | FARS (overturn)      | Douglas Co.      | SR-470                         | 1      | 1993 Grand Cherokee | 80460  |
| 01/10/05 <sup>F</sup>      | FARS                 | Mesa Co.         | Rim Rock Dr.                   | 1      | 2004 Grand Cherokee | 80025  |
| 07/06/08**                 | FARS (boulder)       | Garfield Co.     | US-6                           | 1      | 1997 Grand Cherokee | 80229  |
| <b>Connecticut</b>         |                      |                  |                                |        |                     |        |
| 04/10/97**                 | FARS (tree)          | Washington       | 199                            | 1      | 1994 Grand Cherokee | 90062  |
| 04/19/02**                 | FARS (tree)          | Hamden           | New Rd.                        | 1      | 1994 Grand Cherokee | 90113  |
| 02/16/10 <sup>F</sup>      | FARS                 | North Stonington | Wintechog Hill Rd.             | 1      | 2004 Grand Cherokee | 90023  |
| <b>Delaware</b>            |                      |                  |                                |        |                     |        |
| 09/11/03*                  | FARS                 | Sussex Co.       | CR321                          | 1      | 1993 Grand Cherokee | 100090 |
| <b>D.C.</b>                |                      |                  |                                |        |                     |        |
| <b>Florida</b>             |                      |                  |                                |        |                     |        |
| 11/16/98*†(2)              | FARS                 | Hillsborough Co. | SR580                          | 2      | 1998 Grand Cherokee | 122093 |
| 11/17/01**                 | FARS (overturn)      | Jacksonville     | I-295                          | 1      | 1996 Grand Cherokee | 122302 |
| 09/05/07 <sup>F</sup>      | FARS                 | N/A              | SR-944 32 <sup>nd</sup> Ave.   | 2      | 1998 Grand Cherokee | 122577 |
| 10/07/10 <sup>F</sup> †(1) | FARS                 | Columbia Co.     | US-441                         | 2      | 1998 Grand Cherokee | 121645 |
| 11/16/10 <sup>F-R</sup>    | Manuel Bringas-Mejia | Lake Mary        | I-4                            | 1      | 1997 Grand Cherokee | N/A    |
| <b>Georgia</b>             |                      |                  |                                |        |                     |        |
| 12/04/97*                  | FARS                 | Wilkes Co.       | SR10                           | 1      | 1997 Grand Cherokee | 131268 |
| 07/14/98*                  | FARS                 | Echols Co.       | US-SR89                        | 3      | 1993 Grand Cherokee | 130723 |
| 12/13/98**                 | FARS (tree)          | Forsyth Co.      | SR-371                         | 1      | 1996 Grand Cherokee | 131315 |
| 05/30/99**                 | FARS (embankment)    | Jones Co.        | US-129(SR-11)                  | 2      | 1994 Grand Cherokee | 130444 |
| 08/13/01**                 | FARS (barrier)       | DeKalb Co.       | I-20 (SR 402)                  | 1      | 1998 Grand Cherokee | 130795 |
| 10/30/04*†(4)              | FARS                 | Tift Co.         | I-75                           | 4      | 1999 Grand Cherokee | 131171 |
| 03/08/05 <sup>F</sup>      | FARS                 | Paulding Co.     | N/A                            | 1      | 1999 Grand Cherokee | 130196 |
| 03/09/05 <sup>F</sup>      | FARS                 | Macon Co.        | SR-49                          | 1      | 1997 Grand Cherokee | 130197 |
| 03/24/05*                  | FARS                 | Barrow Co.       | SR-11                          | 1      | 1993 Grand Cherokee | 130251 |
| 06/20/06*                  | FARS                 | Polk             | SR-101                         | 1      | 2003 Grand Cherokee | 130713 |
| 09/04/07**                 | FARS (overturn)      | McDuffie Co.     | SR-223                         | 1      | 1998 Grand Cherokee | 130958 |

| Crash Date by State        | Name                   | City/County       | Road                   | Deaths | Make/Model/Year     | FARS # |
|----------------------------|------------------------|-------------------|------------------------|--------|---------------------|--------|
| 04/29/10 <sup>F</sup>      | Kyle Ray Bryant        | Cobb Co.          | Sewell Mill Rd.        | 1      | 2000 Grand Cherokee | 130319 |
| <b>Illinois</b>            |                        |                   |                        |        |                     |        |
| 09/04/00 <sup>F</sup>      | Nguyen, Bui, Vo, Prith | Chicago           | I-90/94                | 6      | 1993 Grand Cherokee | 170827 |
| 03/02/01*                  | FARS                   | Elk Grove Village | Thorndale Ave.         | 1      | 1998 Grand Cherokee | 170153 |
| 08/12/02**                 | FARS (tree)            | Barrington Hills  | Spring Creek Rd.       | 1      | 1998 Grand Cherokee | 170755 |
| 03/16/03*                  | FARS                   | Livingston Co.    | SR-17                  | 1      | 1994 Grand Cherokee | 170248 |
| 10/11/03*†(1)              | FARS                   | Union Co.         | I-57                   | 2      | 1996 Grand Cherokee | 171040 |
| 02/16/04*                  | FARS                   | Kankakee Co.      | SR-113 7000 West       | 2      | 1999 Grand Cherokee | 170112 |
| 06/02/05*†(1)              | FARS                   | Coles Co.         | SR-16                  | 2      | 1999 Grand Cherokee | 170556 |
| 10/23/05*†(1)              | FARS                   | Iroquois Co.      | I-57                   | 1      | 1998 Grand Cherokee | 170921 |
| 01/04/06*†(1)              | FARS                   | South Elgin       | SR-25                  | 2      | 2001 Grand Cherokee | 170006 |
| 03/18/07**                 | FARS (overturn)        | Du Page Co.       | I-290 WB Ramp to 355S  | 2      | 1995 Grand Cherokee | 170143 |
| 10/16/07 <sup>F</sup>      | FARS                   | La Salle Co.      | I-39                   | 2      | 1993 Grand Cherokee | 170830 |
| 02/20/09*                  | FARS                   | Boone Co.         | I-90                   | 1      | 2001 Grand Cherokee | 170079 |
| 06/26/09 <sup>F</sup>      | Trayvon Roberts        | Chicago           | California and Jackson | 1      | 1996 Grand Cherokee | 170385 |
| <b>Indiana</b>             |                        |                   |                        |        |                     |        |
| 04/27/98*†(1)              | FARS                   | Clay Co.          | I-70                   | 3      | 1997 Grand Cherokee | 180232 |
| 09/16/04 <sup>F</sup>      | FARS                   | Warrick Co.       | I-64                   | 1      | 2004 Grand Cherokee | 180705 |
| 11/13/04 <sup>F</sup>      | FARS                   | Noble Co.         | US-33                  | 4      | 1997 Grand Cherokee | 180723 |
| 10/10/08**                 | FARS (tree)            | Taylorsville      | I-65                   | 1      | 1994 Grand Cherokee | 180552 |
| 09/18/10 <sup>F</sup>      | FARS                   | Goshen            | CR-31                  | 1      | 1997 Grand Cherokee | 180537 |
| <b>Iowa</b>                |                        |                   |                        |        |                     |        |
| 09/07/01**                 | FARS (overturn)        | Patterson         | US-92                  | 1`     | 2001 Grand Cherokee | 190254 |
| <b>Kentucky</b>            |                        |                   |                        |        |                     |        |
| 02/13/00 <sup>F</sup>      | FARS                   | Bourbon Co.       | Vemont Ln.             | 1      | 1997 Grand Cherokee | 210052 |
| 08/07/06*†(1)              | FARS                   | Boone Co.         | SR-536                 | 1      | 1998 Grand Cherokee | 210489 |
| 10/12/10*                  | FARS                   | Warren Co.        | SR-101                 | 1      | 1999 Grand Cherokee | 210547 |
| <b>Louisiana</b>           |                        |                   |                        |        |                     |        |
| 08/31/00*                  | FARS                   | Livingston Co.    | I-12                   | 1      | 1997 Grand Cherokee | 220509 |
| 12/10/00*                  | FARS                   | St. Martin Co.    | I-10                   | 2      | 1997 Grand Cherokee | 220771 |
| 07/20/03 <sup>F</sup> †(3) | FARS                   | St. Martin Co.    | I-10                   | 5      | 2000 Grand Cherokee | 220401 |
| 07/16/04**                 | FARS (utility pole)    | Bossier City      | US-80 SR-72            | 2      | 1999 Grand Cherokee | 220414 |
| 10/09/04**                 | FARS (tree)            | Franklin Co.      | SR-4 School St.        | 1      | 1995 Grand Cherokee | 220625 |

| <b>Crash Date by State</b> | <b>Name</b>               | <b>City/County</b> | <b>Road</b>         | <b>Deaths</b> | <b>Make/Model/Year</b> | <b>FARS #</b> |
|----------------------------|---------------------------|--------------------|---------------------|---------------|------------------------|---------------|
| 12/02/10*                  | FARS (overturn)           | Avoyelles Co.      | SR-453              | 1             | 1998 Grand Cherokee    | 220562        |
| <b>Maryland</b>            |                           |                    |                     |               |                        |               |
| 11/29/98*                  | FARS                      | Baltimore Co.      | SR-147              | 2             | 1993 Grand Cherokee    | 240486        |
| <b>Massachusetts</b>       |                           |                    |                     |               |                        |               |
| 03/04/07**                 | FARS (overturn)           | Centerville        | SR-28 Harrison Road | 2             | 2004 Grand Cherokee    | 250100        |
| 04/29/07**                 | FARS (tree)               | South Easton       | SR-106              | 1             | 1993 Grand Cherokee    | 250070        |
| 03/08/10*                  | FARS (tree)               | Wareham            | I-495               | 1             | 2004 Grand Cherokee    | 250027        |
| <b>Michigan</b>            |                           |                    |                     |               |                        |               |
| 12/04/97*                  | FARS                      | Dickinson Co.      | 95                  | 1             | 1994 Grand Cherokee    | 261050        |
| 01/03/03**                 | FARS (tree)               | Ottawa Co.         | Lakewood Blvd.      | 1             | 1993 Grand Cherokee    | 260036        |
| 04/30/05 <sup>F</sup> †(1) | FARS                      | Oakland Co.        | I-75                | 3             | 2004 Grand Cherokee    | 260239        |
| 08/16/08**                 | FARS (overturn)           | Kalkaska Co.       | Plum Valley Rd.     | 1             | 1996 Grand Cherokee    | 260547        |
| <b>Minnesota</b>           |                           |                    |                     |               |                        |               |
| 02/09/98*                  | FARS                      | Carlton Co.        | SR-33               | 1             | 1994 Grand Cherokee    | 270039        |
| 11/15/98*†(1)              | FARS                      | Maple Grove        | I-94                | 1             | 1993 Grand Cherokee    | 270520        |
| 11/03/02*                  | FARS                      | Scott Co.          | I-35                | 1             | 2001 Grand Cherokee    | 270542        |
| 04/15/03*                  | FARS                      | Aitkin Co.         | 28                  | 1             | 2000 Grand Cherokee    | 270128        |
| 07/14/03*†(1)              | FARS                      | Maple Grove        | I-94                | 1             | 1993 Grand Cherokee    | 270274        |
| 12/29/03**                 | FARS (overturn)           | Lac Qui Parle Co.  | T-148               | 1             | 1995 Grand Cherokee    | 270511        |
| 06/06/04**                 | FARS (overturn)           | Washington Co.     | T92                 | 1             | 1999 Grand Cherokee    | 270160        |
| 05/24/05**                 | FARS (overturn)           | Carver Co.         | 13                  | 4             | 1994 Grand Cherokee    | 270148        |
| 01/27/06*                  | FARS                      | Brown Co.          | 25                  | 1             | 2004 Grand Cherokee    | 270038        |
| 03/21/08*†(1)              | FARS                      | St. Louis Co.      | SR-169 CR88         | 2             | 1995 Grand Cherokee    | 270070        |
| <b>Mississippi</b>         |                           |                    |                     |               |                        |               |
| 12/27/99*                  | FARS                      | Hancock Co.        | I-10                | 3             | 1995 Grand Cherokee    | 280793        |
| 09/01/04*†(2)              | Will Franklin, Tom Walton | Quitman Co.        | Meucci Rd.          | 2             | 1996 Grand Cherokee    | 280493        |
| 10/08/05**                 | FARS (tree)               | Tishomingo Co.     | US-72               | 1             | 1999 Grand Cherokee    | 280587        |
| <b>Missouri</b>            |                           |                    |                     |               |                        |               |
| 11/13/98**                 | FARS (overturn)           | Gasconade Co.      | SR-KK               | 1             | 1996 Grand Cherokee    | 290877        |
| 01/23/00*†(7)              | FARS                      | Platte Co.         | I-29                | 10            | 1996 Grand Cherokee    | 290069        |
| 12/03/00**                 | FARS (tree)               | Greene Co.         | SR-13               | 3             | 1995 Grand Cherokee    | 290907        |
| 08/02/02*†(1)              | FARS                      | Camden Co.         | SR-C                | 1             | 1996 Grand Cherokee    | 290600        |

| Crash Date by State           | Name                   | City/County       | Road                      | Deaths | Make/Model/Year     | FARS # |
|-------------------------------|------------------------|-------------------|---------------------------|--------|---------------------|--------|
| 09/04/02*†(1)                 | FARS                   | Maryland Heights  | I-270                     | 1      | 1997 Grand Cherokee | 290695 |
| 11/17/02**                    | FARS (tree)            | Kansas City       | 63 <sup>rd</sup> St.      | 1      | 1995 Grand Cherokee | 290923 |
| 06/05/04**                    | FARS (overturn)        | St. Louis         | Lee Ave. Fair Ave.        | 1      | 1995 Grand Cherokee | 290473 |
| 06/14/06*                     | FARS                   | Kennett           | US-412                    | 1      | 1997 Grand Cherokee | 290392 |
| 02/01/08*†(1)                 | FARS                   | Osage Co.         | US-50                     | 1      | 1997 Grand Cherokee | 290069 |
| 01/30/09**                    | FARS(concrete barrier) | Kansas City       | Locust St. and Truman Rd. | 1      | 2005 Grand Cherokee | 290068 |
| <b>Nebraska</b>               |                        |                   |                           |        |                     |        |
| 12/19/06 <sup>F</sup> †(1)    | FARS                   | Pierce Co.        | 553 Ave. 849 Rd.          | 1      | 2000 Grand Cherokee | 310215 |
| 06/24/08**                    | FARS (overturn)        | Dawes Co.         | Slim Buttes Rd.           | 1      | 1998 Grand Cherokee | 310085 |
| <b>Nevada</b>                 |                        |                   |                           |        |                     |        |
| <b>New Hampshire</b>          |                        |                   |                           |        |                     |        |
| 07/21/00*†(1)                 | FARS                   | Hampton           | SR-101                    | 1      | 1994 Grand Cherokee | 330066 |
| <b>New Jersey</b>             |                        |                   |                           |        |                     |        |
| 01/05/01**                    | FARS (other object)    | Gloucester Co.    | Cedar Swamp Rd.           | 1      | 1996 Grand Cherokee | 340016 |
| 09/23/05**                    | FARS (parked veh.)     | Union             | I-78                      | 1      | 1998 Grand Cherokee | 340462 |
| 03/31/06*                     | FARS                   | Mansfield         | US-130                    | 1      | 1999 Grand Cherokee | 340144 |
| 02/24/07 <sup>F</sup>         | Susan Kline            | Parsippany        | I-287                     | 1      | 1996 Grand Cherokee | 340080 |
| 06/26/10 <sup>F</sup>         | FARS                   | Sussex Co.        | Hibler Rd.                | 1      | 1996 Grand Cherokee | 340237 |
| 09/17/10 <sup>F</sup>         | FARS                   | Holmdel           | Garden State Pkwy.        | 1      | 1997 Grand Cherokee | 340416 |
| <b>New Mexico</b>             |                        |                   |                           |        |                     |        |
| 03/08/02*†(7)                 | FARS                   | Guadalupe Co.     | I-40                      | 7      | 1999 Grand Cherokee | 350350 |
| 09/19/09**                    | FARS (overturn)        | Luna Co.          | SR-9                      | 2      | 2000 Grand Cherokee | 350155 |
| <b>New York</b>               |                        |                   |                           |        |                     |        |
| 08/21/99 <sup>F</sup>         | FARS                   | Henrietta         | I-390                     | 1      | 1996 Grand Cherokee | 360956 |
| 09/01/99* <sup>F-A</sup> †(1) | Jose Sierra            | Southampton       | SR-27                     | 1      | 1997 Grand Cherokee | 360720 |
| 09/02/99**                    | FARS (overturn)        | East Moriches     | SR-27                     | 1      | 1997 Grand Cherokee | 360153 |
| 12/19/02**                    | FARS (parked veh.)     | Yonkers           | I-87                      | 1      | 2002 Grand Cherokee | 361116 |
| 03/14/04*†(1)                 | FARS                   | Wyoming Co.       | CR-13 CR-16               | 1      | 1993 Grand Cherokee | 360170 |
| 08/14/04**†(1)                | FARS (overturn)        | Palmyra           | SR-21                     | 1      | 1994 Grand Cherokee | 360847 |
| 12/17/06 <sup>F</sup>         | FARS                   | Greenfield Center | SR-9                      | 1      | 1996 Grand Cherokee | 361158 |
| 08/15/07 <sup>F</sup>         | FARS                   | Duanesburg        | I-88                      | 1      | 1993 Grand Cherokee | 360655 |
| 06/19/08 <sup>F</sup>         | FARS                   | Churubusco        | River Rd.                 | 1      | 2004 Grand Cherokee | 360417 |



| Crash Date by State        | Name   | City/County    | Road                            | Deaths | Make/Model/Year     | FARS # |
|----------------------------|--|----------------|---------------------------------|--------|---------------------|--------|
| 01/26/09 <sup>F</sup>      | Arthur Reece, Larissa<br>Reece, Delano<br>Anderson | Islip          | I-495                           | 3      | 1995 Grand Cherokee | 360030 |
| <b>North Carolina</b>      |  |                |                                 |        |                     |        |
| 12/19/99**                 | FARS (tree)  | Columbus Co.   | US-74-76                        | 1      | 1994 Grand Cherokee | 371297 |
| 03/09/02*†(2)              | FARS   | Nash Co.       | US-64                           | 2      | 1998 Grand Cherokee | 370211 |
| 12/03/10*                  | FARS (tree)  | Edgecombe Co.  | RP-1223                         | 1      | 1994 Grand Cherokee | 371134 |
| <b>North Dakota</b>        |  |                |                                 |        |                     |        |
| 07/24/06**                 | FARS (overturn)                                    | Stark Co.      | SR-10 114 <sup>th</sup> Ave. SW | 1      | 1993 Grand Cherokee | 380051 |
| <b>Ohio</b>                |  |                |                                 |        |                     |        |
| 07/30/95**                 | FARS (culvert)                                     | Hilliard       | Hayden Run Road                 | 1      | 1993 Grand Cherokee | 390650 |
| 09/26/97 <sup>F</sup>      | FARS   | Wood Co.       | SR65                            | 1      | 1993 Grand Cherokee | 390948 |
| 09/05/98*                  | FARS   | Delaware Co.   | US-42                           | 1      | 1996 Grand Cherokee | 390810 |
| 12/17/98*                  | FARS   | Guernsey Co.   | I-70                            | 1      | 1993 Grand Cherokee | 391178 |
| 11/23/99*†(2)              | FARS   | Tuscarawas Co. | I-77                            | 2      | 1996 Grand Cherokee | 391139 |
| 03/24/01**                 | FARS (tree)  | Chillicothe    | Bellevue Ave.                   | 1      | 1996 Grand Cherokee | 390067 |
| 06/29/02*                  | FARS   | Sandusky Co.   | SR-600                          | 1      | 1997 Grand Cherokee | 390544 |
| 05/28/03*†(1)              | FARS   | Lawrence Co.   | SR-378                          | 1      | 1998 Grand Cherokee | 390409 |
| 11/29/03*                  | FARS   | Lakeview       | US-33                           | 1      | 1999 Grand Cherokee | 391018 |
| <b>Oklahoma</b>            |  |                |                                 |        |                     |        |
| 05/26/01 <sup>F</sup> †(1) | FARS   | Oklahoma City  | S. Choctaw Rd.                  | 2      | 1993 Grand Cherokee | 400185 |
| <b>Oregon</b>              |  |                |                                 |        |                     |        |
| 09/22/95*                  | FARS   | Grant Co.      | 5                               | 1      | 1993 Grand Cherokee | 410353 |
| 09/20/97**                 | FARS (overturn)                                    |                | 205/DOT440                      | 2      | 1994 Grand Cherokee | 410303 |
| <b>Pennsylvania</b>        |  |                |                                 |        |                     |        |
| 10/24/98**                 | FARS (tree)  | Franklin Co.   | I-76                            | 2      | 1998 Grand Cherokee | 421049 |
| 03/05/00 <sup>F</sup>      | FARS   | Bucks Co.      | SR-309                          | 1      | 1993 Grand Cherokee | 420157 |
| 09/21/03*†(1)              | FARS   | Clinton Co.    | SR-120                          | 2      | 1994 Grand Cherokee | 421054 |
| 02/27/04*                  | FARS   | York Co.       | I-83                            | 2      | 2000 Grand Cherokee | 420293 |
| 07/03/05**                 | FARS (tree)  | Philadelphia   | SR-4013                         | 1      | 1993 Grand Cherokee | 420613 |
| 04/05/06**                 | FARS (overturn)                                    | Clarion Co.    | Nickleville Rd.                 | 1      | 1995 Grand Cherokee | 420249 |
| 11/30/06*                  | FARS   | Warren Co.     | SR-0059                         | 1      | 1995 Grand Cherokee | 421006 |
| 11/12/07*†(1)              | FARS   | Lackawanna Co. | SR-435                          | 1      | 2000 Grand Cherokee | 421144 |

| <b>Crash Date by State</b> | <b>Name</b>                             | <b>City/County</b> | <b>Road</b>                           | <b>Deaths</b> | <b>Make/Model/Year</b> | <b>FARS #</b> |
|----------------------------|---|--------------------|---------------------------------------|---------------|------------------------|---------------|
| 02/16/08**                 | FARS (tree)                             | Erie Co.           | SR-5                                  | 1             | 2002 Grand Cherokee    | 420105        |
| 08/02/10*                  | FARS (tree)                             | Greene Co.         | SR-1021                               | 1             | 2004 Grand Cherokee    | 420567        |
| <b>Rhode Island</b>        |   |                    |                                       |               |                        |               |
| 07/12/02**                 | FARS (tree)                             | Scituate           | SR-116                                | 1             | 1998 Grand Cherokee    | 440023        |
| <b>South Carolina</b>      |   |                    |                                       |               |                        |               |
| 08/06/99 <sup>F</sup>      | FARS                                    | Marlboro Co.       | 259                                   | 2             | 1993 Grand Cherokee    | 450527        |
| 05/21/00 <sup>F</sup>      | FARS                                    | Hampton            | SR-68                                 | 1             | 1994 Grand Cherokee    | 450396        |
| 12/17/03** <sup>F-A</sup>  | Bennett Hartsel, Brett Jones (overturn) | Johns Island       | River Road                            | 2             | 2002 Grand Cherokee    | 450884        |
| 04/25/05*                  | FARS                                    | Richland Co.       | I-20 SR-277                           | 1             | 1998 Grand Cherokee    | 450360        |
| 07/07/08 <sup>F</sup>      | FARS                                    | Georgetown Co.     | US-17 545                             | 1             | 1996 Grand Cherokee    | 450425        |
| <b>South Dakota</b>        |   |                    |                                       |               |                        |               |
| 03/23/07**                 | FARS (overturn)                         | Moody Co.          | SR-34                                 | 1             | 1998 Grand Cherokee    | 460021        |
| <b>Tennessee</b>           |   |                    |                                       |               |                        |               |
| 08/31/01 <sup>F</sup>      | FARS                                    | Jackson            | McClellan Rd.                         | 1             | 1999 Grand Cherokee    | 470731        |
| 08/31/02 <sup>F</sup>      | FARS                                    | Lawrence Co.       | Old Jackson Hwy.                      | 1             | 1994 Grand Cherokee    | 470669        |
| 05/29/04 <sup>F</sup>      | FARS                                    | Germantown         | Stout Rd.                             | 1             | 1996 Grand Cherokee    | 471036        |
| 08/01/05**                 | FARS (bridge pier)                      | Kingsport          | I-181                                 | 1             | 1997 Grand Cherokee    | 471107        |
| 11/18/06*†(1)              | FARS                                    | Wilson Co.         | Saundersville Rd. Cedar Creek Village | 1             | 1998 Grand Cherokee    | 471136        |
| 12/16/06**                 | FARS (tree)                             | Mount Juliet       | South Greenhill Rd.                   | 1             | 1999 Grand Cherokee    | 470904        |
| 03/19/09**                 | FARS (embankment)                       | Eads               | SR-205                                | 1             | 2004 Grand Cherokee    | 470443        |
| <b>Texas</b>               |   |                    |                                       |               |                        |               |
| 06/22/97*                  | FARS                                    | Cass Co.           | 59                                    | 1             | 1996 Grand Cherokee    | 481932        |
| 01/16/98 <sup>F</sup>      | FARS                                    | Brazoria Co.       | SR-288                                | 1             | 1994 Grand Cherokee    | 480087        |
| 11/11/00**                 | FARS (tree)                             | Gonzales Co.       | SR-97                                 | 1             | 1997 Grand Cherokee    | 482644        |
| 06/09/04 <sup>F</sup>      | FARS                                    | Victoria Co.       | US-77                                 | 1             | 2002 Grand Cherokee    | 481205        |
| 12/12/04*†(1)              | FARS                                    | Dallas             | I-35E                                 | 1             | 1998 Grand Cherokee    | 483248        |
| 08/06/05 <sup>F</sup>      | FARS                                    | Bullard            | FM344                                 | 1             | 1996 Grand Cherokee    | 481685        |
| 02/12/06* <sup>F-A</sup>   | Cassidy Jarmon                          | Cleburne           | SR-174                                | 1             | 1993 Grand Cherokee    | 480273        |
| 04/28/06*                  | FARS                                    | Dallas             | I-30                                  | 2             | 2000 Grand Cherokee    | 480867        |
| 7/10/09 <sup>F</sup>       | Rodney Wood                             | Fort Worth         | NE Loop 820                           | 1             | 2004 Grand Cherokee    | 481432        |

| <b>Crash Date by State</b> | <b>Name</b>     | <b>City/County</b> | <b>Road</b>               | <b>Deaths</b> | <b>Make/Model/Year</b> | <b>FARS #</b> |
|----------------------------|-----------------|--------------------|---------------------------|---------------|------------------------|---------------|
| 12/31/10*                  | FARS (post)     | Anderson Co.       | FM2054                    | 1             | 1999 Grand Cherokee    | 482581        |
| <b>Vermont</b>             |                 |                    |                           |               |                        |               |
| 04/10/00*                  | FARS            | Swanton            | I-89                      | 1             | 1998 Grand Cherokee    | 500019        |
| 09/11/08*                  | FARS            | Waterbury          | SR-100                    | 1             | 1998 Grand Cherokee    | 500049        |
| 06/01/09*†(1)              | FARS            | Saint Albans       | US-7 and Jewett Ave.      | 1             | 1998 Grand Cherokee    | 500025        |
| <b>Virginia</b>            |                 |                    |                           |               |                        |               |
| 08/08/03*                  | FARS            | Washington Co.     | SR-75                     | 1             | 1998 Grand Cherokee    | 510627        |
| <b>Washington</b>          |                 |                    |                           |               |                        |               |
| 03/15/06**                 | FARS (tree)     | Auburn             | SR-164                    | 2             | 1995 Grand Cherokee    | 530101        |
| 12/06/09 <sup>F</sup>      | James R. Smith  | Okanogan           | Rendezvous Rd.            | 1             | 2003 Grand Cherokee    | 530405        |
| <b>West Virginia</b>       |                 |                    |                           |               |                        |               |
| 12/06/03**                 | FARS (tree)     | Kanawha Co.        | US-60                     | 1             | 1994 Grand Cherokee    | 540342        |
| 09/30/06 <sup>F</sup>      | FARS            | Charleston         | Hickory Rd. Overbrook Rd. | 1             | 1998 Grand Cherokee    | 540269        |
| <b>Wisconsin</b>           |                 |                    |                           |               |                        |               |
| 05/18/03 <sup>F</sup>      | FARS            | Grant Co.          | SR-133                    | 1             | 1996 Grand Cherokee    | 550248        |
| 07/03/04**                 | FARS (tree)     | Columbia           | Hopkins Rd.               | 1             | 1995 Grand Cherokee    | 550318        |
| 07/03/07 <sup>F</sup>      | Stacy Mayer     | Nashotah           | SR-16                     | 1             | 2001 Grand Cherokee    | 550300        |
| 09/09/07**                 | FARS (overtake) | Greenfield         | I-43                      | 1             | 1994 Grand Cherokee    | 550455        |
| 10/21/09**                 | FARS (tree)     | Rock Co.           | US-14                     | 1             | 2007 Grand Cherokee    | 550391        |
| <b>Wyoming</b>             |                 |                    |                           |               |                        |               |
| 04/04/03*                  | FARS            | Converse Co.       | I-25                      | 1             | 1993 Grand Cherokee    | 560022        |

<sup>F</sup> Indicated in FARS as most harmful: "fire/explosion."

\* Indicated in FARS as most harmful: "motor vehicle in transport" or "motor vehicle in transport in other roadway."

\*\* Item in parentheses is most harmful event as indicated in FARS.

<sup>F-A</sup> Fire listed as cause of death in autopsy report or death certificate.

<sup>F-L</sup> Fire indicated as cause of death in litigation.

<sup>F-R</sup> Fire indicated as cause of death in accident report.

† Fatality(s) (#) occurred in bullet vehicle

# Tab 9

ABC News Reports on Subject (dvd) +  
Digital version of this letter w/hyperlinks (cd)

-----

Paul V. Sheridan letter of 13 February 2012 to Congressmen:

Representative Elijah Cummings  
Representative James D. Jordan  
Representative Mike Kelly  
Representative Dennis Kucinich

Subject: 1993-2004 Jeep Grand Cherokee Post-Collision Fire Death Defect Investigation  
Reference: House Oversight and Government Reform Hearing (Chevrolet Volt) of 25Jan2012



## **Tab-9 Video Links**

ABC News : Jeep Grand Cherokee Fire Deaths Reports (3)

[Part 1](#)

[Part 2](#)

[Part 2](#)

-----

[Chrysler Testimony on Jeep Crashworthiness \(Francois J. Castaing\)](#)

[President Barack Obama Announces Prior Ownership of Jeep Grand Cherokee](#)

# Tab 10

NHTSA-Chrysler-DOJ Defect Investigation FOIA Conspiracy

(Affirmed under oath by Chrysler Chairman Robert Eaton  
And Chrysler Vice Chairman Robert Lutz)

-----  
Paul V. Sheridan letter of 13 February 2012 to Congressmen:

Representative Elijah Cummings  
Representative James D. Jordan  
Representative Mike Kelly  
Representative Dennis Kucinich

Subject: 1993-2004 Jeep Grand Cherokee Post-Collision Fire Death Defect Investigation  
Reference: House Oversight and Government Reform Hearing (Chevrolet Volt) of 25Jan2012



MINIVAN LATCH ISSUE

Proposed Agreement with NHTSA

1. Crash Test Video and the Public Record:

- NHTSA has agreed that they will deny all FOIA requests to place their investigative files, including the crash test video, on the public record and that the Department of Justice will defend any lawsuits seeking to compel production under FOIA.

We would agree with NHTSA that their engineering analysis will remain open while we conduct the service campaign to provide them additional bases to argue that release of the materials would interfere with their investigation.

- The Department of Justice says there is less than a 50/50 chance of keeping the video off the record for the full duration of the investigation, i.e. the campaign, if there is a court ruling. Given the possibility that a lawsuit could be filed at any time, they anticipate that the legal process would take at least four months, regardless of the outcome.

2. Service Action Only - No Recall: NHTSA has agreed that a Chrysler service campaign would fully satisfy all of their concerns and they would give full public support to such an effort. The critical elements that differentiate the service campaign from a recall (mostly reflected in the two attached letters) are as follows:

- no admission of defect or safety problem;
- stated purpose of the campaign - to ensure peace of mind in light of media coverage;
- campaign does not count as a NHTSA action - not included in NHTSA recall numbers, no Part 573 or Part 577 letters;
- statements to owners, the public and NHTSA assert that no defect has been found; and
- NHTSA acknowledges that replacement latch is not a 100% solution.

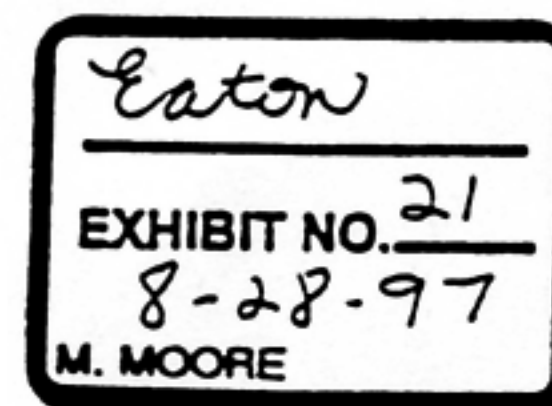



3. **Chrysler Announcement:** Chrysler controls publication of its action with the following provisions:

- Chrysler goes first with its own statement and reads approved NHTSA statement supporting Chrysler's action;
- Chrysler characterizes campaign as done solely to ensure the peace of mind of its owners, i.e. "your concern is our concern";
- Letter from Martinez to Chrysler and NHTSA press statement praise Chrysler action as fully satisfying all of NHTSA's concerns and state that Chrysler is a safety leader;
- NHTSA officials acknowledge publicly that there has been no finding of defect and that there will be none; and
- NHTSA officials acknowledge that owners should not be concerned over the delayed implementation of the action and that they can best protect themselves by keeping seat belts buckled at all times.

4. **Additional Provisions:** The following points have been requested by NHTSA and appear to be reasonable:

- The letter to owners makes reference to the NHTSA hot line phone number;
- Latch replacement will be offered as part of any routine minivan servicing (once replacement latches are available);
- Chrysler will submit six quarterly reports on the progress of the campaign (helps to support defense of FOIA requests); and
- NHTSA can make reference to the service campaign in response to owner inquiries.



# End of Tab B

Paul V. Sheridan letter of 13 February 2012 to Congressmen:

Representative Elijah Cummings  
Representative James D. Jordan  
Representative Mike Kelly  
Representative Dennis Kucinich

Subject: 1993-2004 Jeep Grand Cherokee Post-Collision Fire Death Defect Investigation  
Reference: House Oversight and Government Reform Hearing (Chevrolet Volt) of 25Jan2012

# Tab C

Chrysler Group LLC Recall announcement of 7 March 2012

**Subject:** 2004 thru 2005 Jeep Liberty Corrosion of Rear Lower Control Arms

March 7, 2012

### **Recall Statement for 2004 - 2005 Jeep® Liberty Rear Lower Control Arms**

Auburn Hills, Mich. , Mar 7, 2012 - Chrysler Group LLC will conduct a voluntary safety recall of some 2004 - 2005 Jeep® Liberty models that may experience excessive corrosion on the rear lower control arms. This could lead to a weakening of the component and potential fracture resulting in a decrease in rear suspension stability.

"The excessive corrosion is a result of extended exposure to road salt, which is why the campaign is limited to vehicles originally sold or currently registered in salt belt states as defined by the NHSTA," said David Dillon, Head of Product Investigation and Campaigns, Chrysler Group LLC.

Chrysler Group LLC is not is not aware of any accidents or injuries related to this issue.

Approximately 267,353 Jeep Liberty models (209,746 U.S. and 24,727 Canada) produced from July 3, 2003 through July 14, 2005 are affected.

-###-

Additional information and news from Chrysler Group LLC is available at:  
<http://www.media.chrysler.com>

# Tab D

Paul V. Sheridan letter of 13 February 2012 to Plaintiff's Counsel:

*Ms. Angel M. DeFilippo, Esq.  
Grieco, Oates & DeFilippo, LLC  
Suite 200  
414 Eagle Rock Avenue  
West Orange, NJ 07052  
973-243-2099*

**Subject:** Jeep Grand Cherokee MHE / Fire Death Accident of 6 March 2012



22357 Columbia Street  
Dearborn, MI 48124  
313-277-5095  
pvsheridan@wowway.com

3 April 2012

BY FACSIMILE AND EMAIL

Ms. Angel M. De Filippo, Esq.  
Grieco, Oates & De Filippo, LLC  
Suite 200  
414 Eagle Rock Avenue  
West Orange, NJ 07052  
973-243-2099

**Subject: Jeep Grand Cherokee MHE / Fire Death Accident of 6 March 2012**

Dear Ms. De Filippo:

Attached is a 'State of Georgia Traffic Crash Report' that was forwarded to me by the Center for Auto Safety (Contact: Clarence Ditlow, 202-328-7700 ext 105).

Please note the attached states that a 1999 Jeep Grand Cherokee underwent a "FIRE/EXPLOSION" as the "Most Harmful Event Detail," subsequent to a foreseeable rear-end collision. The only death victim, four-year old Remington Waldon, was "Trapped," while restrained by a second position/row "booster seat."

Responding to your question regarding the "K" designation of the "FATAL INJURY" entry, I telephoned [Troop G of the Georgia State Patrol](#) (229-931-2400). I was informed that it means "Killed."

As you recall, I attended the 14 June 2011 deposition of former Chrysler Executive Vice President Francois Castaing wherein he testified about the decision to override the recommendation that the-then upcoming 1993 'Jeep Grand Cherokee' be based on the N-Body (Dodge Dakota) engineering platform. You will note that the offending vehicle in the subject report is a Dodge Dakota, and does not exhibit any fire related issues during this 6 March 2012 accident sequence.

I will telephone [Troop G Post 14 Commander SFC Charles M. Godby](#) as soon as possible to schedule a non-physical/photographic inspection of the subject accident vehicles.

Please do not hesitate to contact me at any time.

Respectfully,

Paul V. Sheridan

cc: Courtney E. Morgan, Esq.



# STATE OF GEORGIA TRAFFIC CRASH REPORT

Georgia State Patrol  
Georgia Department of Public Safety  
P.O. Box 1456  
Atlanta, Georgia 30371-1456

|                                      |  |   |   |
|--------------------------------------|--|---|---|
| Crash Number<br><b>C000078901-01</b> | Reporting Agency<br><b>GEORGIA DEPARTMENT OF PUBLIC SAFETY</b> | Reporting Agency Case Number<br><b>C000078901</b> | Reporting Agency CAD Number<br><b>GSPG12CAD008592</b> |
|--------------------------------------|--|---|---|

### CRASH IDENTIFIERS

|  |   |   |   |  |  |
|--|---|---|---|--|--|
| County of Crash<br><b>DECATUR</b>                | City or Place of Crash<br><b>BAINBRIDGE</b>           | <input checked="" type="checkbox"/> City Limits | Crash Date/Time<br><b>03/06/2012 03:45 PM</b>                     | Reported Date/Time<br><b>03/06/2012 03:52 PM</b>       | Dispatched Date/Time<br><b>03/06/2012 03:53 PM</b> |
| On Scene Date/Time<br><b>03/06/2012 04:39 PM</b> | Cleared Scene Date/Time<br><b>03/06/2012 07:45 PM</b> | Complete Date/Time                              | Reason (if Investigation Not Complete)<br><b>PENDING SCRT INV</b> | Source of Information<br><b>LAW ENFORCEMENT AGENCY</b> |  |

### ROADWAY INFORMATION

|   |  |   |   |                                  |
|---|--|---|---|----------------------------------|
| Roadway Description for Location of Occurrence<br><b>OLD QUINCY HWY</b>                 |  | Distance to City or Place of Crash                            | Latitude<br><b>N 30 53.4708</b>               | Longitude<br><b>W 84 35.3914</b> |
| Intersecting Roadway Description for Location of Occurrence<br><b>HUBERT DOLLAR DR.</b> |  | Distance / Direction from Crash Location                      | <input type="checkbox"/> Roadway Blocked      | Roadway Cleared Date/Time        |
| Part of National Highway System<br><b>NO</b>  | Roadway Functional Class Type<br><b>RURAL</b>                | Roadway Functional Class Detail<br><b>LOCAL</b>               |   |                                  |
| Type of Shoulder<br><b>UNPAVED</b>  | Roadway Lighting<br><b>NO LIGHTING</b>                       | Roadway Bikeway Facility<br><b>NONE</b>                       | Signed Bicycle Route<br><b>NOT APPLICABLE</b> |                                  |
| Traffic Control Type at Intersection<br><b>NO CONTROL</b>                               | Mainline Number of Lanes at Intersection<br><b>TWO LANES</b> | Side Road Number of Lanes at Intersection<br><b>TWO LANES</b> |   |                                  |

### CRASH INFORMATION

|   |                                   |   |  |  |                     |                        |                       |                           |                        |                        |
|---|-----------------------------------|---|--|--|---------------------|------------------------|-----------------------|---------------------------|------------------------|------------------------|
| Light Condition<br><b>DAYLIGHT</b>                                | Weather Condition<br><b>CLEAR</b> | Roadway Surface Condition<br><b>DRY</b>                         | <input checked="" type="checkbox"/> Crash Pictures Taken |  |                     |                        |                       |                           |                        |                        |
| First Harmful Event Type<br><b>COLLISION NON-FIXED OBJECT</b>     |                                   | First Harmful Event Detail<br><b>MOTOR VEHICLE IN TRANSPORT</b> |  |  |                     |                        |                       |                           |                        |                        |
| Total Counts  | Vehicles<br><b>2</b>              | CMV<br><b>0</b>   | Motorists<br><b>3</b>                                    | Non-Motorists<br><b>0</b>                              | Injured<br><b>2</b> | Fatalities<br><b>1</b> | Witnesses<br><b>2</b> | Other Persons<br><b>0</b> | Businesses<br><b>0</b> | Violations<br><b>0</b> |
| First Harmful Event's Relation to Junction<br><b>NON-JUNCTION</b> |                                   | Is First Harmful Event within Interchange Area<br><b>NO</b>     |  | Type of Intersection<br><b>T-INTERSECTION</b>          |                     |                        |                       |                           |                        |                        |
| Contributing Circumstances: Environment<br><b>NONE</b>            |                                   | Contributing Circumstances: Environment<br><b>NONE</b>          |  | Contributing Circumstances: Environment<br><b>NONE</b> |                     |                        |                       |                           |                        |                        |
| Contributing Circumstances: Road<br><b>NONE</b>                   |                                   | Contributing Circumstances: Road<br><b>NONE</b>                 |  | Contributing Circumstances: Road<br><b>NONE</b>        |                     |                        |                       |                           |                        |                        |
| School Bus Related<br><b>NO</b>                                   |                                   | Work Zone Related<br><b>NO</b>                                  |  | Crash Location in Work Zone                            |                     |                        |                       |                           |                        |                        |

### VEHICLE V01

|  |   |   |  |   |   |                                 |
|--|---|---|--|---|---|---------------------------------|
| <b>V01</b>   | Motor Vehicle Type<br><b>MOTOR VEHICLE IN TRANSPORT</b> | State<br><b>GA</b>  | License Number<br><b>[REDACTED]</b>                        | Registration Expires<br><b>[REDACTED]</b>                   | <input type="checkbox"/> Permanent Registration | VIN<br><b>1B7GL23Y2VS157706</b> |
| Year<br><b>1997</b>  | Make<br><b>DODGE</b>                                    | Model<br><b>DAKOTA DAKOTA</b>   | Style<br><b>TK</b>   | Color<br><b>BLK</b>   | Body Type Category<br><b>PICKUP</b>             |                                 |
| Special Function of Motor Vehicle in Transport<br><b>NO SPECIAL FUNCTION</b>             |   | Emergency Motor Vehicle Use<br><b>NO</b>  |  | Type of Bus Use<br><b>NOT A BUS</b>                         |   |                                 |
| Owner First Name<br><b>BRYAN</b>   | Owner Middle Name<br><b>LAMAR</b>                       | Owner Last Name<br><b>HARRELL</b>   | Owner Suffix   | Owner Business (if not Person)                              |   |                                 |
| Address<br><b>208 DOLLAR DR</b>  |   | Address Other   |  | City<br><b>BAINBRIDGE</b>                                   | State<br><b>GA</b>                              | Zip Code<br><b>39819-3321</b>   |
| Owner Phone Number   | Owner Phone Number (other)                              | Insurance Company<br><b>THE GENERALAUTO INS SVCS GA</b>                           |  | Insurance Policy Number<br><b>17-GA1037150</b>              |   |                                 |
| Vehicle Removal<br><b>TOWED DUE TO DISABLING DAMAGE</b>                                  |   | Vehicle Towed By<br><b>MYERS</b>  |  | Wrecker Selection Method<br><b>ROTATION</b>                 |   |                                 |
| Direction of Travel Before Crash<br><b>NORTHBOUND</b>                                    | Speed: Estimated<br><b>55</b>                           | Posted  | Roadway Type<br><b>UNDIVIDED HIGHWAY</b>                   | Total Lanes<br><b>2</b>                                     | Roadway Horizontal Alignment<br><b>STRAIGHT</b> | Roadway Grade<br><b>LEVEL</b>   |
| Trafficway Description<br><b>TWO-WAY NOT DIVIDED</b>                                     |   | Traffic Control Device Type<br><b>NO CONTROLS</b>                                 |  | Working Properly  |   |                                 |
| Roadway Description for Vehicle Travel<br><b>OLD QUINCY HIGHWAY @ HUBERT DOLLAR</b>      |   |   |  |   |   |                                 |
| Vehicle Maneuver Action (by this vehicle)<br><b>MOVEMENTS ESSENTIALLY STRAIGHT AHEAD</b> |   | Hit & Run (by this vehicle)<br><b>NO DID NOT LEAVE SCENE</b>                      |  | Damage Extent (for this vehicle)<br><b>DISABLING DAMAGE</b> |   |                                 |
| 1st Sequence of Events Type (this vehicle)<br><b>COLLISION NON-FIXED OBJECT</b>          |   | 1st Sequence of Events Detail (this vehicle)<br><b>MOTOR VEHICLE IN TRANSPORT</b> |  |   |   |                                 |
| 2nd Sequence of Events Type (this vehicle)<br><b>COLLISION WITH FIXED OBJECT</b>         |   | 2nd Sequence of Events Detail (this vehicle)<br><b>TREE (STANDING)</b>            |  |   |   |                                 |
| 3rd Sequence of Events Type (this vehicle)<br><b>UNKNOWN</b>                             |   | 3rd Sequence of Events Detail (this vehicle)                                      |  |   |   |                                 |
| 4th Sequence of Events Type (this vehicle)<br><b>UNKNOWN</b>                             |   | 4th Sequence of Events Detail (this vehicle)                                      |  |   |   |                                 |
| Most Harmful Event Type (this vehicle)<br><b>COLLISION NON-FIXED OBJECT</b>              |   | Most Harmful Event Detail (this vehicle)<br><b>MOTOR VEHICLE IN TRANSPORT</b>     |  |   |   |                                 |
| Contributing Circumstances 1 (this vehicle)<br><b>NONE</b>                               |   |   | Contributing Circumstances 2 (this vehicle)<br><b>NONE</b> |   |   |                                 |

Area of Initial Impact

- Non Collision
- Top
- Undercarriage
- Unknown

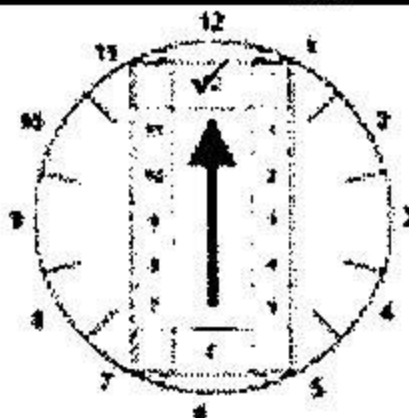

Most Damaged Area

- Non Collision
- Top
- Undercarriage
- Unknown

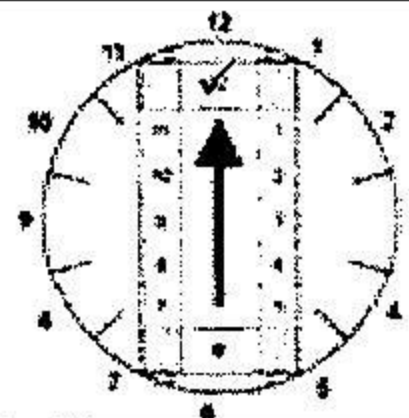

Occupant Type  
**DRIVER**

Person Name (First Middle Last Suffix)  
**BRYAN LAMAR HARRELL**

Injury Status  
**NON FATAL INJURY**

### VEHICLE V02

|  |   |  |                                     |   |  |                                 |
|--|---|--|-------------------------------------|---|--|---------------------------------|
| <b>V02</b>   | Motor Vehicle Type<br><b>MOTOR VEHICLE IN TRANSPORT</b> | State<br><b>GA</b>                       | License Number<br><b>[REDACTED]</b> | Registration Expires<br><b>[REDACTED]</b> | <input type="checkbox"/> Permanent Registration      | VIN<br><b>1J4GW58S2XC631075</b> |
| Year<br><b>1999</b>  | Make<br><b>JEEP</b>                                     | Model<br><b>GRAND CHEROKEE</b>           | Style<br><b>MP</b>                  | Color<br><b>GLD</b>                       | Body Type Category<br><b>(SPORT) UTILITY VEHICLE</b> |                                 |
| Special Function of Motor Vehicle in Transport<br><b>NO SPECIAL FUNCTION</b> |   | Emergency Motor Vehicle Use<br><b>NO</b> |                                     | Type of Bus Use<br><b>NOT A BUS</b>       |  |                                 |



|  |  |  |  |   |  |  |   |                                |          |
|--|--|--|--|---|--|--|---|--------------------------------|----------|
| Crash Number<br>C000078901-01  |  | Reporting Agency<br>GEORGIA DEPARTMENT OF PUBLIC SAFETY                                    |  |   | Reporting Agency Case Number<br>C000078901 |  | Reporting Agency CAD Number<br>GSPG12CAD008592    |                                |          |
| Owner First Name<br>LENWOOD  |  | Owner Middle Name<br>E   |  | Owner Last Name<br>NEWSOME JR   |  | Owner Suffix   |   | Owner Business (if not Person) |          |
| Address<br>1109 STEWART AVE  |  |  | Address Other  |   |  | City<br>BAINBRIDGE   | State<br>GA                                       | Zip Code<br>39819-4856         |          |
| Owner Phone Number   |  | Owner Phone Number (other)   |  | Insurance Company<br>PROGRESSIVE  |  | Insurance Policy Number<br>UNK   |   |                                |          |
| Vehicle Removal<br>TOWED DUE TO DISABLING DAMAGE   |  |  |  | Vehicle Towed By<br>MYERS   |  | Wrecker Selection Method<br>ROTATION   |   |                                |          |
| Direction of Travel Before Crash<br>NORTHBOUND   |  | Speed: Estimated<br>55   | Posted<br>55   |   | Roadway Type<br>UNDIVIDED HIGHWAY          | Total Lanes<br>2   | Roadway Horizontal Alignment<br>STRAIGHT          | Roadway Grade<br>LEVEL         |          |
| Trafficway Description<br>TWO-WAY NOT DIVIDED  |  |  |  |   | Traffic Control Device Type<br>NO CONTROLS |  | Working Properly                                  |                                |          |
| Roadway Description for Vehicle Travel<br>OLD QUINCY HWY @ HUBERT DOLLAR DR  |  |  |  |   |  |  |   |                                |          |
| Vehicle Maneuver Action (by this vehicle)<br>TURNING LEFT  |  |  | Hit & Run (by this vehicle)<br>NO DID NOT LEAVE SCENE  |   |  | Damage Extent (for this vehicle)<br>DISABLING DAMAGE                         |   |                                |          |
| 1st Sequence of Events Type (this vehicle)<br>COLLISION NON-FIXED OBJECT   |  |  |  | 1st Sequence of Events Detail (this vehicle)<br>MOTOR VEHICLE IN TRANSPORT  |  |  |   |                                |          |
| 2nd Sequence of Events Type (this vehicle)<br>NON-COLLISION  |  |  |  | 2nd Sequence of Events Detail (this vehicle)<br>FIRE/EXPLOSION  |  |  |   |                                |          |
| 3rd Sequence of Events Type (this vehicle)<br>UNKNOWN  |  |  |  | 3rd Sequence of Events Detail (this vehicle)  |  |  |   |                                |          |
| 4th Sequence of Events Type (this vehicle)<br>UNKNOWN  |  |  |  | 4th Sequence of Events Detail (this vehicle)  |  |  |   |                                |          |
| Most Harmful Event Type (this vehicle)<br>NON-COLLISION  |  |  |  | Most Harmful Event Detail (this vehicle)<br>FIRE/EXPLOSION  |  |  |   |                                |          |
| Contributing Circumstances 1 (this vehicle)<br>NONE  |  |  |  | Contributing Circumstances 2 (this vehicle)<br>NONE   |  |  |   |                                |          |
| Area of Initial Impact<br><input type="checkbox"/> Non Collision<br><input type="checkbox"/> Top<br><input type="checkbox"/> Undercarriage<br><input type="checkbox"/> Unknown |  |  |  | Most Damaged Area<br><input type="checkbox"/> Non Collision<br><input type="checkbox"/> Top<br><input type="checkbox"/> Undercarriage<br><input type="checkbox"/> Unknown |  |  |   |                                |          |
| Occupant Type<br>DRIVER<br>PASSENGER   |  | Person Name (First Middle Last Suffix)<br>EMILY CATHERINE NEWSOME<br>REMINGTON COLE WALDON |  |   |  | Injury Status<br>NON FATAL INJURY<br>FATAL INJURY (K)                        |   |                                |          |
| <b>DRIVER V01</b>  |  |  |  |   |  |  |   |                                |          |
| Person Type<br>DRIVER  |  | NM#  | Vehicle#<br>V01  | Person Type Detail  |  |  |   |                                |          |
| First Name<br>BRYAN  |  | Middle Name<br>LAMAR   |  | Last Name<br>HARRELL  |  | Suffix   | Date of Birth                                     | Age                            | Sex<br>M |
| Address<br>208 DOLLAR DR   |  |  | Address Other  |   |  | City<br>BAINBRIDGE   | State<br>GA                                       | Zip Code<br>39819              |          |
| Phone Number   |  | Phone Number (other)   |  | Condition at Time of Crash<br>UNKNOWN   |  |  |   |                                |          |
| Driver License Number  |  | Class  | Expires  | State<br>GA   | Jurisdiction<br>02                         | Type<br>NON-CDL DRIVER'S LICENSE   |   | Status<br>VALID LICENSE        |          |
| Drivers License Restrictions 1<br>NONE   |  |  | Drivers License Restrictions 2<br>NONE                 |   |  | Drivers License Restrictions 3<br>NONE                                       |   |                                |          |
| Driver Distracted By<br>NOT DISTRACTED   |  |  |  | Driver Vision Obstructions<br>VISION NOT OBSCURED   |  |  |   |                                |          |
| Driver Actions at Time of Crash 1 (based on judgement of investigation officer)<br>OPERATED MOTOR VEHICLE IN ERRATIC, RECKLESS, CARELESS, NEGLIGENT O                          |  |  |  | Driver Actions at Time of Crash 2 (based on judgement of investigation officer)<br>RAN OFF ROADWAY  |  |  |   |                                |          |
| Driver Actions at Time of Crash 3 (based on judgement of investigation officer)<br>NO CONTRIBUTING ACTION  |  |  |  | Driver Actions at Time of Crash 4 (based on judgement of investigation officer)<br>NO CONTRIBUTING ACTION   |  |  |   |                                |          |
| Motor Vehicle Seating Position: Row<br>FRONT   |  | Motor Vehicle Seating Position: Seat<br>LEFT   |  | Motor Vehicle Seating Position: Other<br>NOT APPLICABLE   |  |  | <input type="checkbox"/> Seating Position Unknown |                                |          |
| Restraint Systems<br>SHOULDER AND LAP BELT USED  |  |  |  | Helmet Use  |  |  |   |                                |          |
| Air Bag Deployed<br>DEPLOYED-FRONT   |  |  |  | Ejection<br>NOT EJECTED   |  |  |   |                                |          |
| Trapped Extraction<br>NOT TRAPPED  |  |  |  |   |  |  |   |                                |          |
| Injury Severity Level Type<br>NON FATAL INJURY   |  |  | Injury Severity Level Detail<br>NON-INCAPACITATING (B) |   |  | Primary or Most Obvious of Body Area Injured During Crash<br>LOWER EXTREMITY |   |                                |          |
| Source of Transport to Medical Facility<br>NOT TRANSPORTED   |  | EMS Agency Name or ID  |  | EMS Run Number  |  | Medical Facility Transported To  |   |                                |          |
| Law Enforcement Suspected Alcohol Use<br>UNKNOWN   |  | Alcohol Test Type<br>BLOOD   |  | Alcohol Testec<br>TEST GIVEN  |  | Alcohol Test Result<br>PENDING   |   | BAC                            |          |
| Law Enforcement Suspected Drug Use<br>UNKNOWN  |  | Drug Test Type<br>BLOOD  |  | Drug Testec<br>TEST GIVEN   |  | Drug Test Result<br>PENDING  |   |                                |          |
| <b>DRIVER V02</b>  |  |  |  |   |  |  |   |                                |          |
| Person Type<br>DRIVER  |  | NM#  | Vehicle#<br>V02  | Person Type Detail  |  |  |   |                                |          |
| First Name<br>EMILY  |  | Middle Name<br>CATHERINE   |  | Last Name<br>NEWSOME  |  | Suffix   | Date of Birth                                     | Age                            | Sex<br>F |
| Address<br>1109 STEWART AVE  |  |  | Address Other  |   |  | City<br>BAINBRIDGE   | State<br>GA                                       | Zip Code<br>39819              |          |
| Phone Number   |  | Phone Number (other)   |  | Condition at Time of Crash<br>APPARENTLY NORMAL   |  |  |   |                                |          |
| Driver License Number  |  | Class  | Expires  | State<br>GA   | Jurisdiction<br>02                         | Type<br>NON-CDL DRIVER'S LICENSE   |   | Status<br>VALID LICENSE        |          |
| Drivers License Restrictions 1<br>NONE   |  |  | Drivers License Restrictions 2<br>NONE                 |   |  | Drivers License Restrictions 3<br>NONE                                       |   |                                |          |
| Driver Distracted By<br>NOT DISTRACTED   |  |  |  | Driver Vision Obstructions<br>VISION NOT OBSCURED   |  |  |   |                                |          |
| Driver Actions at Time of Crash 1 (based on judgement of investigation officer)<br>NO CONTRIBUTING ACTION  |  |  |  | Driver Actions at Time of Crash 2 (based on judgement of investigation officer)<br>NO CONTRIBUTING ACTION   |  |  |   |                                |          |



|  |  |  |                        |  |  |  |                    |                          |                 |
|--|--|--|------------------------|--|--|--|--------------------|--------------------------|-----------------|
| Crash Number<br><b>C000078901-01</b>   |  | Reporting Agency<br><b>GEORGIA DEPARTMENT OF PUBLIC SAFETY</b> |                        | Reporting Agency Case Number<br><b>C000078901</b>  |  | Reporting Agency CAD Number<br><b>GSPG12CAD008592</b>        |                    |                          |                 |
| Driver Actions at Time of Crash 3 (based on judgement of investigation officer)<br><b>NO CONTRIBUTING ACTION</b> |  |  |                        | Driver Actions at Time of Crash 4 (based on judgement of investigation officer)<br><b>NO CONTRIBUTING ACTION</b> |  |  |                    |                          |                 |
| Motor Vehicle Seating Position: Row<br><b>FRONT</b>  |  | Motor Vehicle Seating Position: Seat<br><b>LEFT</b>            |                        | Motor Vehicle Seating Position: Other<br><b>NOT APPLICABLE</b>   |  | <input type="checkbox"/> Seating Position Unknown            |                    |                          |                 |
| Restraint Systems<br><b>SHOULDER AND LAP BELT USED</b>   |  |  |                        | Helmet Use   |  |  |                    |                          |                 |
| Air Bag Deployed<br><b>DEPLOYMENT UNKNOWN</b>  |  |  |                        | Ejection<br><b>NOT EJECTED</b>   |  |  |                    |                          |                 |
| Trapped Extrication<br><b>NOT TRAPPED</b>  |  |  |                        |  |  |  |                    |                          |                 |
| Injury Severity Level Type<br><b>NON FATAL INJURY</b>  |  | Injury Severity Level Detail<br><b>NON-INCAPACITATING (B)</b>  |                        | Primary or Most Obvious of Body Area Injured During Crash<br><b>UNSPECIFIED</b>                                  |  |  |                    |                          |                 |
| Source of Transport to Medical Facility<br><b>EMS GROUND</b>   |  | EMS Agency Name or ID<br><b>DECATUR EMS</b>                    |                        | EMS Run Number<br><b>0661</b>  |  | Medical Facility Transported To<br><b>BAINBRIDGE ER</b>      |                    |                          |                 |
| Law Enforcement Suspected Alcohol Use<br><b>NO</b>   |  | Alcohol Test Type  |                        | Alcohol Testec<br><b>TEST NOT GIVEN</b>  |  | Alcohol Test Result<br><b>BAC</b>                            |                    |                          |                 |
| Law Enforcement Suspected Drug Use<br><b>NO</b>  |  | Drug Test Type   |                        | Drug Testec<br><b>TEST NOT GIVEN</b>   |  | Drug Test Result   |                    |                          |                 |
| <b>PASSENGER V02</b>   |  |  |                        |  |  |  |                    |                          |                 |
| Person Type<br><b>PASSENGER</b>  |  | NM#  | Vehicle#<br><b>V02</b> | Person Type Detail   |  |  |                    |                          |                 |
| First Name   |  | Middle Name  |                        | Last Name  |  | Suffix   | Date of Birth      | Age                      | Sex<br><b>M</b> |
| Address  |  |  | Address Other          |  |  | City<br><b>BAINBRIDGE</b>                                    | State<br><b>GA</b> | Zip Code<br><b>39817</b> |                 |
| Phone Number   |  | Phone Number (other)   |                        | Condition at Time of Crash<br><b>APPARENTLY NORMAL</b>   |  |  |                    |                          |                 |
| Motor Vehicle Seating Position: Row<br><b>SECOND</b>   |  | Motor Vehicle Seating Position: Seat<br><b>RIGHT</b>           |                        | Motor Vehicle Seating Position: Other  |  | <input checked="" type="checkbox"/> Seating Position Unknown |                    |                          |                 |
| Restraint Systems<br><b>BOOSTER SEAT</b>   |  |  |                        | Helmet Use   |  |  |                    |                          |                 |
| Air Bag Deployed<br><b>NOT APPLICABLE</b>  |  |  |                        | Ejection<br><b>NOT EJECTED</b>   |  |  |                    |                          |                 |
| Trapped Extrication<br><b>TRAPPED</b>  |  |  |                        |  |  |  |                    |                          |                 |
| Injury Severity Level Type<br><b>FATAL INJURY (K)</b>  |  | Injury Severity Level Detail                                   |                        | Primary or Most Obvious of Body Area Injured During Crash<br><b>UNSPECIFIED</b>                                  |  |  |                    |                          |                 |
| Source of Transport to Medical Facility<br><b>EMS GROUND</b>   |  | EMS Agency Name or ID  |                        | EMS Run Number<br><b>UNK</b>   |  | Medical Facility Transported To<br><b>DECATUR MORGUE</b>     |                    |                          |                 |
| <b>WITNESS</b>   |  |  |                        |  |  |  |                    |                          |                 |
| Person Type<br><b>WITNESS</b>  |  | NM#  | Vehicle#               | Person Type Detail   |  |  |                    |                          |                 |
| First Name<br><b>ANDY</b>  |  | Middle Name  |                        | Last Name<br><b>MCQUAID</b>  |  | Suffix   | Date of Birth      | Age                      | Sex<br><b>M</b> |
| Address<br><b>907 ELIZABETH PL</b>   |  |  | Address Other          |  |  | City<br><b>BAINBRIDGE</b>                                    | State<br><b>GA</b> | Zip Code<br><b>39819</b> |                 |
| Phone Number   |  | Phone Number (other)   |                        | Condition at Time of Crash<br><b>APPARENTLY NORMAL</b>   |  |  |                    |                          |                 |
| <b>WITNESS</b>   |  |  |                        |  |  |  |                    |                          |                 |
| Person Type<br><b>WITNESS</b>  |  | NM#  | Vehicle#               | Person Type Detail   |  |  |                    |                          |                 |
| First Name<br><b>KIZZIE</b>  |  | Middle Name  |                        | Last Name<br><b>BROWN</b>  |  | Suffix   | Date of Birth      | Age                      | Sex<br><b>F</b> |
| Address<br><b>1620 BETHEL RD</b>   |  |  | Address Other          |  |  | City<br><b>BAINBRIDGE</b>                                    | State<br><b>GA</b> | Zip Code<br><b>39817</b> |                 |
| Phone Number   |  | Phone Number (other)   |                        | Condition at Time of Crash<br><b>APPARENTLY NORMAL</b>   |  |  |                    |                          |                 |
| <b>NON VEHICLE PROPERTY DAMAGE</b>   |  |  |                        |  |  |  |                    |                          |                 |
| Description of Damaged Property<br><b>CITY OF BAINBRIDGE ROAD SIGN</b>   |  |  |                        |  |  |  | Estimated Damage   |                          |                 |
| Property Linked to Person / Business   |  |  |                        |  |  |  |                    |                          |                 |

**NARRATIVE: C000078901**

Vehicle 1 was traveling north on Old Quincy Hwy. Vehicle 2 was attempting to make a left turn onto Hubert Dollar Drive from Old Quincy Hwy. As vehicle 2 was making left turn on Hubert Dollar Drive, vehicle 1 struck vehicle 2 in the rear. Vehicle 1 ran off the right side of road into the east ditch of Old Quincy Hwy striking a tree. Vehicle 2 spun to a uncontrolled stop into the west ditch of Old Quincy Hwy.

Note: Further investigation being conducted by SCRT Team 5.



|   |                     |  |  |   |                    |  |  |
|---|---------------------|--|--|---|--------------------|--|--|
| <b>REPORTING OFFICER</b>                          |                     |  |  | <b>APPROVING OFFICER (SUPERVISOR)</b>     |                    |  |  |
| Reporting Officer Name<br><b>LANDRUM JR, W.R.</b> |                     | Signature<br> |  | Approving Officer Name<br><b>GODBY, C</b> |                    | Signature<br> |  |
| ID Number<br><b>0306</b>                          | Rank<br><b>TFC2</b> |  |  | ID Number<br><b>0372</b>                  | Rank<br><b>SFC</b> |  |  |
| Org / Unit<br><b>G-14</b>                         |                     |  |  | Org / Unit<br><b>G-14</b>                 |                    |  |  |



DIAGRAM OF ACCIDENT

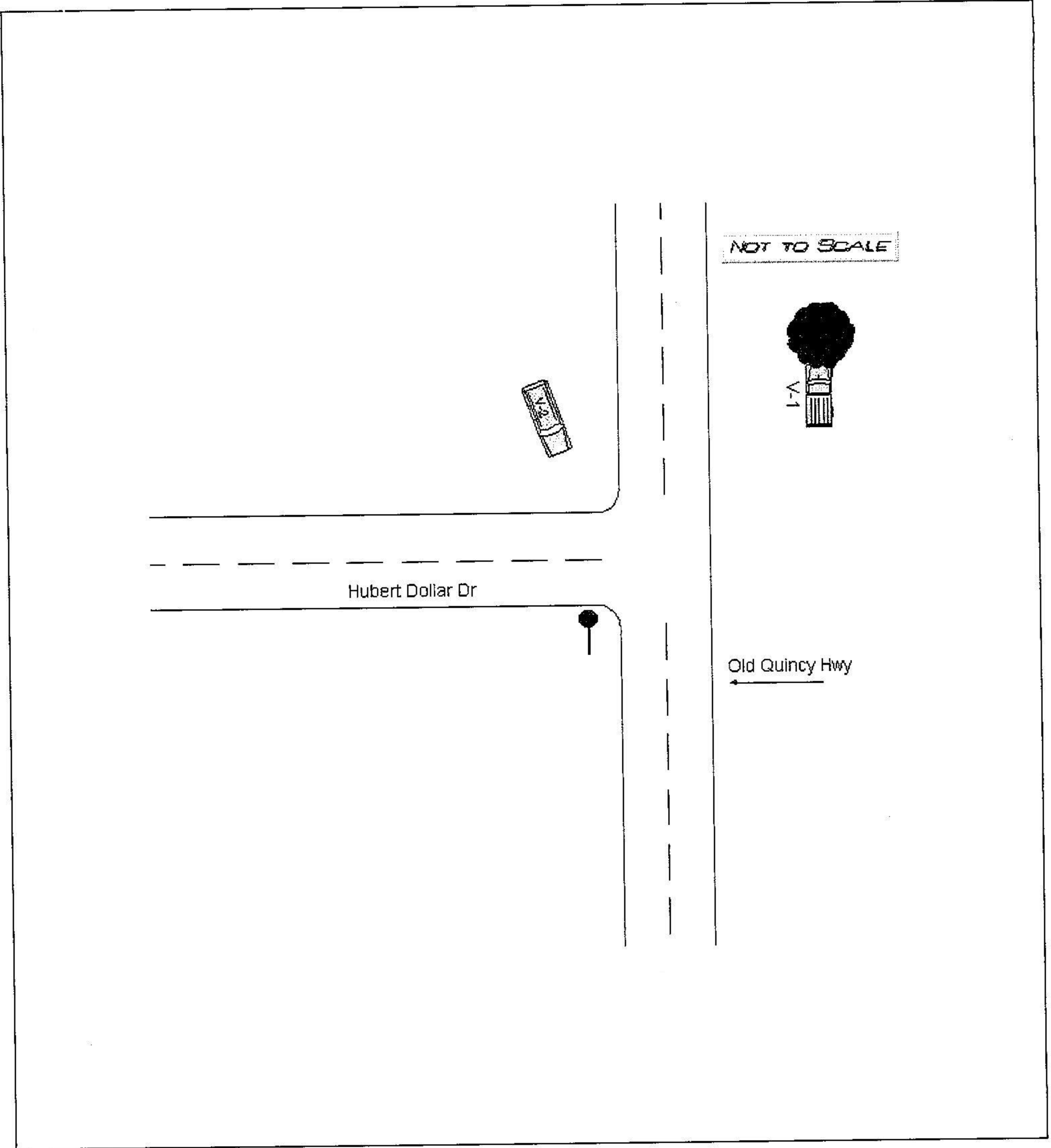

# Tab E

Center for Auto Safety Letter of 5 April 2012 to Chrysler Group LLC Chairman:

*Sergio Marchionne, Chairman  
Chrysler Group LLC  
1000 Chrysler Drive  
Auburn Hills MI 48321-8004*

## **Excerpt:**

“On March 6, 2012, four year old Remington Cole Walden was killed despite riding in a child booster seat to protect him when the 1999 Jeep Grand Cherokee driven by his aunt was struck from behind and engulfed in flames.”

---

# CENTER FOR AUTO SAFETY

1825 CONNECTICUT AVENUE NW SUITE 330 WASHINGTON DC 20009-5708  
202-328-7700 ◆ www.autosafety.org

April 5, 2012

Sergio Marchionne, Chairman  
Chrysler Group LLC  
1000 Chrysler Drive  
Auburn Hills MI 48321-8004

Dear Chairman Marchionne:

On February 12, 2006, four year old Cassidy Jarmon was killed despite riding in a child seat to protect her when the 1993 Jeep Grand Cherokee driven by her mother was struck from behind and burst into flames.

On March 6, 2012, four year old Remington Cole Walden was killed despite riding in a child booster seat to protect him when the 1999 Jeep Grand Cherokee driven by his aunt was struck from behind and engulfed in flames.



The other occupants in the crashes could not get the above pictured four year olds out because they were trapped in the flaming vehicle.

Remington is but the latest fatality in 201 fatal fire crashes with 285 deaths involving 1993-2004 Jeep Grand Cherokees. [Attached] In just 2010 to now, there have been 14 more known fatal fire crashes with at least 7 deaths with fire as the most harmful event. When will the killing end, when will 4-year olds stop being burned to death in Jeep Grand Cherokees? Only you can end the killing. Tell the government which is investigating this defect, "Chrysler will recall all 1993-2004 Jeep Grand Cherokees."

Sincerely,



Clarence Ditlow  
Executive Director

### **MY 1993-2004 Jeep Grand Cherokee Fatal Fire Crashes, 1992-2010**

This table includes known fire crashes obtained from NHTSA's Fatal Analysis Crash System (FARS) for Calendar Years 1992-2010 and from public records for other years and for crashes not listed in FARS. Where FARS indicates fire is the most harmful event, that is indicated. Where FARS indicates vehicle in transport, striking tree or other object, that is indicated.



| Crash Date by State        | Name                  | City/County         | Road                      | Deaths | Make/Model/Year     | FARS # |
|----------------------------|-----------------------|---------------------|---------------------------|--------|---------------------|--------|
| <b>Alabama</b>             |                       |                     |                           |        |                     |        |
| 09/26/01**                 | FARS (overturn)       | Blount Co.          | US-SR74                   | 2      | 2000 Grand Cherokee | 10627  |
| 04/12/06 <sup>F</sup>      | FARS                  | Montgomery          | 5466                      | 1      | 2004 Grand Cherokee | 10243  |
| 04/25/07 <sup>F</sup>      | FARS                  | Macon Co.           | I-85                      | 1      | 1993 Grand Cherokee | 10270  |
| 05/20/09**                 | FARS (overturn)       | Cedar Bluff         | SR-68                     | 1      | 2002 Grand Cherokee | 10257  |
| <b>Alaska</b>              |                       |                     |                           |        |                     |        |
| 10/12/02*                  | FARS                  | Kenai Peninsula     | I-A3-2 Seward             | 2      | 2000 Grand Cherokee | 20053  |
| <b>Arizona</b>             |                       |                     |                           |        |                     |        |
| 02/01/98 <sup>F</sup>      | FARS                  | Gila Co.            | Old Dripping Springs      | 1      | 1993 Grand Cherokee | 40059  |
| 08/18/98**                 | FARS (bridge rail)    | Mohave Co.          | I-15                      | 1      | 1995 Grand Cherokee | 40506  |
| 03/13/01 <sup>F</sup>      | FARS                  | Mohave Co.          | I-40                      | 2      | 1994 Grand Cherokee | 40104  |
| 11/26/06*†(1)              | FARS                  | Surprise            | US-60 R.H. Johnson Blvd.  | 1      | 1995 Grand Cherokee | 40874  |
| 09/19/09*†(1)              | FARS                  | Tempe               | Baseline Rd. at I-10 Ramp | 1      | 2003 Grand Cherokee | 40551  |
| <b>Arkansas</b>            |                       |                     |                           |        |                     |        |
| 09/14/04*†(1)              | FARS                  | Carroll Co.         | US-62-05                  | 2      | 1999 Grand Cherokee | 50451  |
| <b>California</b>          |                       |                     |                           |        |                     |        |
| 03/06/96*†(1)              | FARS                  | Indio               | Country Club Dr.          | 2      | 1993 Grand Cherokee | 60665  |
| 03/16/96 <sup>F</sup> †(5) | FARS                  | Carson              | 91                        | 5      | 1996 Grand Cherokee | 60718  |
| 07/07/96 <sup>F</sup> †(1) | FARS                  | Poway               | Espola Rd.                | 1      | 1993 Grand Cherokee | 61698  |
| 06/14/98**†(1)             | FARS (barrier)        | Victorville         | I-15                      | 1      | 1993 Grand Cherokee | 60918  |
| 10/27/99 <sup>F</sup>      | Young Sup Lee         | Los Angeles         | SR-170                    | 1      | 1998 Grand Cherokee | 62795  |
| 05/07/00 <sup>F</sup>      | FARS                  | Orange Co.          | SR-241                    | 1      | 1993 Grand Cherokee | 60499  |
| 07/20/01 <sup>F</sup>      | FARS                  | San Bernardino Co.  | I-10                      | 1      | 1994 Grand Cherokee | 61708  |
| 08/07/01**                 | FARS (tree)           | Los Gatos           | SR-17                     | 1      | 1998 Grand Cherokee | 62067  |
| 03/23/02*†(1)              | FARS                  | Sutter Co.          | SR-99                     | 2      | 1995 Grand Cherokee | 61045  |
| 07/13/02**                 | FARS                  | San Luis Obispo Co. | Orcutt Rd.                | 1      | 2000 Grand Cherokee | 60896  |
| 08/30/02 <sup>F</sup>      | FARS                  | Bakersfield         | SR-58                     | 1      | 1993 Grand Cherokee | 62653  |
| 10/11/02**                 | FARS (overturn)       | Fresno Co.          | I-5                       | 1      | 1993 Grand Cherokee | 62779  |
| 10/04/03*                  | FARS                  | Anaheim             | S. Harbor Blvd.           | 2      | 2004 Grand Cherokee | 62897  |
| 11/27/03**                 | FARS (utility pole)   | Commerce            | Slauson Ave.              | 1      | 1996 Grand Cherokee | 63251  |
| 02/05/04*                  | FARS                  | San Bernardino Co.  | I-15                      | 1      | 1995 Grand Cherokee | 60339  |
| 05/26/04**†(2)             | FARS (overturn)       | Vacaville           | I-80                      | 4      | 2004 Grand Cherokee | 61401  |
| 06/08/04**                 | FARS (parked vehicle) | Riverside Co.       | I-10                      | 1      | 1997 Grand Cherokee | 61466  |

| <b>Crash Date by State</b> | <b>Name</b>          | <b>City/County</b> | <b>Road</b>                    | <b>Deaths</b> | <b>Make/Model/Year</b> | <b>FARS #</b> |
|----------------------------|----------------------|--------------------|--------------------------------|---------------|------------------------|---------------|
| 08/18/05 <sup>F</sup>      | James Lindskog       | Oceanside          | Vista Way                      | 1             | 1994 Grand Cherokee    | 63236         |
| 05/24/06 <sup>F</sup> †(1) | FARS                 | Orange Co.         | SR-241                         | 2             | 2001 Grand Cherokee    | 61349         |
| 06/25/06**                 | FARS (tree)          | Sonoma Co.         | Petrified Forest Rd. Sharp Rd. | 1             | 1993 Grand Cherokee    | 62934         |
| <b>Colorado</b>            |                      |                    |                                |               |                        |               |
| 07/24/94*                  | FARS                 | Denver             | Martin Luther King Blvd.       | 1             | 1994 Grand Cherokee    | 80258         |
| 09/02/02**                 | FARS (overturn)      | Douglas Co.        | SR-470                         | 1             | 1993 Grand Cherokee    | 80460         |
| 01/10/05 <sup>F</sup>      | FARS                 | Mesa Co.           | Rim Rock Dr.                   | 1             | 2004 Grand Cherokee    | 80025         |
| 07/06/08**                 | FARS (boulder)       | Garfield Co.       | US-6                           | 1             | 1997 Grand Cherokee    | 80229         |
| <b>Connecticut</b>         |                      |                    |                                |               |                        |               |
| 04/10/97**                 | FARS (tree)          | Washington         | 199                            | 1             | 1994 Grand Cherokee    | 90062         |
| 04/19/02**                 | FARS (tree)          | Hamden             | New Rd.                        | 1             | 1994 Grand Cherokee    | 90113         |
| 02/16/10 <sup>F</sup>      | FARS                 | North Stonington   | Wintechog Hill Rd.             | 1             | 2004 Grand Cherokee    | 90023         |
| <b>Delaware</b>            |                      |                    |                                |               |                        |               |
| 09/11/03*                  | FARS                 | Sussex Co.         | CR321                          | 1             | 1993 Grand Cherokee    | 100090        |
| <b>D.C.</b>                |                      |                    |                                |               |                        |               |
| <b>Florida</b>             |                      |                    |                                |               |                        |               |
| 11/16/98*†(2)              | FARS                 | Hillsborough Co.   | SR580                          | 2             | 1998 Grand Cherokee    | 122093        |
| 11/17/01**                 | FARS (overturn)      | Jacksonville       | I-295                          | 1             | 1996 Grand Cherokee    | 122302        |
| 09/05/07 <sup>F</sup>      | FARS                 | N/A                | SR-944 32 <sup>nd</sup> Ave.   | 2             | 1998 Grand Cherokee    | 122577        |
| 10/07/10 <sup>F</sup> †(1) | FARS                 | Columbia Co.       | US-441                         | 2             | 1998 Grand Cherokee    | 121645        |
| 11/16/11 <sup>F-R</sup>    | Manuel Bringas-Mejia | Lake Mary          | I-4                            | 1             | 1997 Grand Cherokee    | N/A           |
| <b>Georgia</b>             |                      |                    |                                |               |                        |               |
| 12/04/97*                  | FARS                 | Wilkes Co.         | SR10                           | 1             | 1997 Grand Cherokee    | 131268        |
| 07/14/98*                  | FARS                 | Echols Co.         | US-SR89                        | 3             | 1993 Grand Cherokee    | 130723        |
| 12/13/98**                 | FARS (tree)          | Forsyth Co.        | SR-371                         | 1             | 1996 Grand Cherokee    | 131315        |
| 05/30/99**                 | FARS (embankment)    | Jones Co.          | US-129(SR-11)                  | 2             | 1994 Grand Cherokee    | 130444        |
| 08/13/01**                 | FARS (barrier)       | DeKalb Co.         | I-20 (SR 402)                  | 1             | 1998 Grand Cherokee    | 130795        |
| 10/30/04*†(4)              | FARS                 | Tift Co.           | I-75                           | 4             | 1999 Grand Cherokee    | 131171        |
| 03/08/05 <sup>F</sup>      | FARS                 | Paulding Co.       | N/A                            | 1             | 1999 Grand Cherokee    | 130196        |
| 03/09/05 <sup>F</sup>      | FARS                 | Macon Co.          | SR-49                          | 1             | 1997 Grand Cherokee    | 130197        |
| 03/24/05*                  | FARS                 | Barrow Co.         | SR-11                          | 1             | 1993 Grand Cherokee    | 130251        |
| 06/20/06*                  | FARS                 | Polk               | SR-101                         | 1             | 2003 Grand Cherokee    | 130713        |
| 09/04/07**                 | FARS (overturn)      | McDuffie Co.       | SR-223                         | 1             | 1998 Grand Cherokee    | 130958        |

| Crash Date by State        | Name                   | City/County       | Road                   | Deaths | Make/Model/Year     | FARS # |
|----------------------------|------------------------|-------------------|------------------------|--------|---------------------|--------|
| 04/29/10 <sup>F</sup>      | Kyle Ray Bryant        | Cobb Co.          | Sewell Mill Rd.        | 1      | 2000 Grand Cherokee | 130319 |
| 03/06/12 <sup>F-R</sup>    | Remington Walden       | Bainbridge        | Old Quincy Hwy.        | 1      | 1999 Grand Cherokee | N/A    |
| <b>Illinois</b>            |                        |                   |                        |        |                     |        |
| 09/04/00 <sup>F</sup>      | Nguyen, Bui, Vo, Prith | Chicago           | I-90/94                | 6      | 1993 Grand Cherokee | 170827 |
| 03/02/01*                  | FARS                   | Elk Grove Village | Thorndale Ave.         | 1      | 1998 Grand Cherokee | 170153 |
| 08/12/02**                 | FARS (tree)            | Barrington Hills  | Spring Creek Rd.       | 1      | 1998 Grand Cherokee | 170755 |
| 03/16/03*                  | FARS                   | Livingston Co.    | SR-17                  | 1      | 1994 Grand Cherokee | 170248 |
| 10/11/03*†(1)              | FARS                   | Union Co.         | I-57                   | 2      | 1996 Grand Cherokee | 171040 |
| 02/16/04*                  | FARS                   | Kankakee Co.      | SR-113 7000 West       | 2      | 1999 Grand Cherokee | 170112 |
| 06/02/05*†(1)              | FARS                   | Coles Co.         | SR-16                  | 2      | 1999 Grand Cherokee | 170556 |
| 10/23/05*†(1)              | FARS                   | Iroquois Co.      | I-57                   | 1      | 1998 Grand Cherokee | 170921 |
| 01/04/06*†(1)              | FARS                   | South Elgin       | SR-25                  | 2      | 2001 Grand Cherokee | 170006 |
| 03/18/07**                 | FARS (overturn)        | Du Page Co.       | I-290 WB Ramp to 355S  | 2      | 1995 Grand Cherokee | 170143 |
| 10/16/07 <sup>F</sup>      | FARS                   | La Salle Co.      | I-39                   | 2      | 1993 Grand Cherokee | 170830 |
| 02/20/09*                  | FARS                   | Boone Co.         | I-90                   | 1      | 2001 Grand Cherokee | 170079 |
| 06/26/09 <sup>F</sup>      | Trayvon Roberts        | Chicago           | California and Jackson | 1      | 1996 Grand Cherokee | 170385 |
| <b>Indiana</b>             |                        |                   |                        |        |                     |        |
| 04/27/98*†(1)              | FARS                   | Clay Co.          | I-70                   | 3      | 1997 Grand Cherokee | 180232 |
| 09/16/04 <sup>F</sup>      | FARS                   | Warrick Co.       | I-64                   | 1      | 2004 Grand Cherokee | 180705 |
| 11/13/04 <sup>F</sup>      | FARS                   | Noble Co.         | US-33                  | 4      | 1997 Grand Cherokee | 180723 |
| 10/10/08**                 | FARS (tree)            | Taylorsville      | I-65                   | 1      | 1994 Grand Cherokee | 180552 |
| 09/18/10 <sup>F</sup>      | FARS                   | Goshen            | CR-31                  | 1      | 1997 Grand Cherokee | 180537 |
| <b>Iowa</b>                |                        |                   |                        |        |                     |        |
| 09/07/01**                 | FARS (overturn)        | Patterson         | US-92                  | 1      | 2001 Grand Cherokee | 190254 |
| <b>Kentucky</b>            |                        |                   |                        |        |                     |        |
| 02/13/00 <sup>F</sup>      | FARS                   | Bourbon Co.       | Vemont Ln.             | 1      | 1997 Grand Cherokee | 210052 |
| 08/07/06*†(1)              | FARS                   | Boone Co.         | SR-536                 | 1      | 1998 Grand Cherokee | 210489 |
| 10/12/10*                  | FARS                   | Warren Co.        | SR-101                 | 1      | 1999 Grand Cherokee | 210547 |
| <b>Louisiana</b>           |                        |                   |                        |        |                     |        |
| 08/31/00*                  | FARS                   | Livingston Co.    | I-12                   | 1      | 1997 Grand Cherokee | 220509 |
| 12/10/00*                  | FARS                   | St. Martin Co.    | I-10                   | 2      | 1997 Grand Cherokee | 220771 |
| 07/20/03 <sup>F</sup> †(3) | FARS                   | St. Martin Co.    | I-10                   | 5      | 2000 Grand Cherokee | 220401 |
| 07/16/04**                 | FARS (utility pole)    | Bossier City      | US-80 SR-72            | 2      | 1999 Grand Cherokee | 220414 |

| <b>Crash Date by State</b> | <b>Name</b>               | <b>City/County</b> | <b>Road</b>         | <b>Deaths</b> | <b>Make/Model/Year</b> | <b>FARS #</b> |
|----------------------------|---------------------------|--------------------|---------------------|---------------|------------------------|---------------|
| 10/09/04**                 | FARS (tree)               | Franklin Co.       | SR-4 School St.     | 1             | 1995 Grand Cherokee    | 220625        |
| 12/02/10*                  | FARS (overturn)           | Avoyelles Co.      | SR-453              | 1             | 1998 Grand Cherokee    | 220562        |
| <b>Maryland</b>            |                           |                    |                     |               |                        |               |
| 11/29/98*                  | FARS                      | Baltimore Co.      | SR-147              | 2             | 1993 Grand Cherokee    | 240486        |
| <b>Massachusetts</b>       |                           |                    |                     |               |                        |               |
| 03/04/07**                 | FARS (overturn)           | Centerville        | SR-28 Harrison Road | 2             | 2004 Grand Cherokee    | 250100        |
| 04/29/07**                 | FARS (tree)               | South Easton       | SR-106              | 1             | 1993 Grand Cherokee    | 250070        |
| 03/08/10*                  | FARS (tree)               | Wareham            | I-495               | 1             | 2004 Grand Cherokee    | 250027        |
| <b>Michigan</b>            |                           |                    |                     |               |                        |               |
| 12/04/97*                  | FARS                      | Dickinson Co.      | 95                  | 1             | 1994 Grand Cherokee    | 261050        |
| 01/03/03**                 | FARS (tree)               | Ottawa Co.         | Lakewood Blvd.      | 1             | 1993 Grand Cherokee    | 260036        |
| 04/30/05 <sup>F</sup> †(1) | FARS                      | Oakland Co.        | I-75                | 3             | 2004 Grand Cherokee    | 260239        |
| 08/16/08**                 | FARS (overturn)           | Kalkaska Co.       | Plum Valley Rd.     | 1             | 1996 Grand Cherokee    | 260547        |
| <b>Minnesota</b>           |                           |                    |                     |               |                        |               |
| 02/09/98*                  | FARS                      | Carlton Co.        | SR-33               | 1             | 1994 Grand Cherokee    | 270039        |
| 11/15/98*†(1)              | FARS                      | Maple Grove        | I-94                | 1             | 1993 Grand Cherokee    | 270520        |
| 11/03/02*                  | FARS                      | Scott Co.          | I-35                | 1             | 2001 Grand Cherokee    | 270542        |
| 04/15/03*                  | FARS                      | Aitkin Co.         | 28                  | 1             | 2000 Grand Cherokee    | 270128        |
| 07/14/03*†(1)              | FARS                      | Maple Grove        | I-94                | 1             | 1993 Grand Cherokee    | 270274        |
| 12/29/03**                 | FARS (overturn)           | Lac Qui Parle Co.  | T-148               | 1             | 1995 Grand Cherokee    | 270511        |
| 06/06/04**                 | FARS (overturn)           | Washington Co.     | T92                 | 1             | 1999 Grand Cherokee    | 270160        |
| 05/24/05**                 | FARS (overturn)           | Carver Co.         | 13                  | 4             | 1994 Grand Cherokee    | 270148        |
| 01/27/06*                  | FARS                      | Brown Co.          | 25                  | 1             | 2004 Grand Cherokee    | 270038        |
| 03/21/08*†(1)              | FARS                      | St. Louis Co.      | SR-169 CR88         | 2             | 1995 Grand Cherokee    | 270070        |
| <b>Mississippi</b>         |                           |                    |                     |               |                        |               |
| 12/27/99*                  | FARS                      | Hancock Co.        | I-10                | 3             | 1995 Grand Cherokee    | 280793        |
| 09/01/04*†(2)              | Will Franklin, Tom Walton | Quitman Co.        | Meucci Rd.          | 2             | 1996 Grand Cherokee    | 280493        |
| 10/08/05**                 | FARS (tree)               | Tishomingo Co.     | US-72               | 1             | 1999 Grand Cherokee    | 280587        |
| <b>Missouri</b>            |                           |                    |                     |               |                        |               |
| 11/13/98**                 | FARS (overturn)           | Gasconade Co.      | SR-KK               | 1             | 1996 Grand Cherokee    | 290877        |
| 01/23/00*†(7)              | FARS                      | Platte Co.         | I-29                | 10            | 1996 Grand Cherokee    | 290069        |
| 12/03/00**                 | FARS (tree)               | Greene Co.         | SR-13               | 3             | 1995 Grand Cherokee    | 290907        |



| <b>Crash Date by State</b>    | <b>Name</b>            | <b>City/County</b> | <b>Road</b>               | <b>Deaths</b> | <b>Make/Model/Year</b> | <b>FARS #</b> |
|-------------------------------|------------------------|--------------------|---------------------------|---------------|------------------------|---------------|
| 08/02/02*†(1)                 | FARS                   | Camden Co.         | SR-C                      | 1             | 1996 Grand Cherokee    | 290600        |
| 09/04/02*†(1)                 | FARS                   | Maryland Heights   | I-270                     | 1             | 1997 Grand Cherokee    | 290695        |
| 11/17/02**                    | FARS (tree)            | Kansas City        | 63 <sup>rd</sup> St.      | 1             | 1995 Grand Cherokee    | 290923        |
| 06/05/04**                    | FARS (overturn)        | St. Louis          | Lee Ave. Fair Ave.        | 1             | 1995 Grand Cherokee    | 290473        |
| 06/14/06*                     | FARS                   | Kennett            | US-412                    | 1             | 1997 Grand Cherokee    | 290392        |
| 02/01/08*†(1)                 | FARS                   | Osage Co.          | US-50                     | 1             | 1997 Grand Cherokee    | 290069        |
| 01/30/09**                    | FARS(concrete barrier) | Kansas City        | Locust St. and Truman Rd. | 1             | 2005 Grand Cherokee    | 290068        |
| <b>Nebraska</b>               |                        |                    |                           |               |                        |               |
| 12/19/06 <sup>F</sup> †(1)    | FARS                   | Pierce Co.         | 553 Ave. 849 Rd.          | 1             | 2000 Grand Cherokee    | 310215        |
| 06/24/08**                    | FARS (overturn)        | Dawes Co.          | Slim Buttes Rd.           | 1             | 1998 Grand Cherokee    | 310085        |
| <b>Nevada</b>                 |                        |                    |                           |               |                        |               |
| <b>New Hampshire</b>          |                        |                    |                           |               |                        |               |
| 07/21/00*†(1)                 | FARS                   | Hampton            | SR-101                    | 1             | 1994 Grand Cherokee    | 330066        |
| <b>New Jersey</b>             |                        |                    |                           |               |                        |               |
| 01/05/01**                    | FARS (other object)    | Gloucester Co.     | Cedar Swamp Rd.           | 1             | 1996 Grand Cherokee    | 340016        |
| 09/23/05**                    | FARS (parked veh.)     | Union              | I-78                      | 1             | 1998 Grand Cherokee    | 340462        |
| 03/31/06*                     | FARS                   | Mansfield          | US-130                    | 1             | 1999 Grand Cherokee    | 340144        |
| 02/24/07 <sup>F</sup>         | Susan Kline            | Parsippany         | I-287                     | 1             | 1996 Grand Cherokee    | 340080        |
| 06/26/10 <sup>F</sup>         | FARS                   | Sussex Co.         | Hibler Rd.                | 1             | 1996 Grand Cherokee    | 340237        |
| 09/17/10 <sup>F</sup>         | FARS                   | Holmdel            | Garden State Pkwy.        | 1             | 1997 Grand Cherokee    | 340416        |
| <b>New Mexico</b>             |                        |                    |                           |               |                        |               |
| 03/08/02*†(7)                 | FARS                   | Guadalupe Co.      | I-40                      | 7             | 1999 Grand Cherokee    | 350350        |
| 09/19/09**                    | FARS (overturn)        | Luna Co.           | SR-9                      | 2             | 2000 Grand Cherokee    | 350155        |
| <b>New York</b>               |                        |                    |                           |               |                        |               |
| 08/21/99 <sup>F</sup>         | FARS                   | Henrietta          | I-390                     | 1             | 1996 Grand Cherokee    | 360956        |
| 09/01/99* <sup>F-A</sup> †(1) | Jose Sierra            | Southampton        | SR-27                     | 1             | 1997 Grand Cherokee    | 360720        |
| 09/02/99**                    | FARS (overturn)        | East Moriches      | SR-27                     | 1             | 1997 Grand Cherokee    | 360153        |
| 12/19/02**                    | FARS (parked veh.)     | Yonkers            | I-87                      | 1             | 2002 Grand Cherokee    | 361116        |
| 03/14/04*†(1)                 | FARS                   | Wyoming Co.        | CR-13 CR-16               | 1             | 1993 Grand Cherokee    | 360170        |
| 08/14/04**†(1)                | FARS (overturn)        | Palmyra            | SR-21                     | 1             | 1994 Grand Cherokee    | 360847        |
| 12/17/06 <sup>F</sup>         | FARS                   | Greenfield Center  | SR-9                      | 1             | 1996 Grand Cherokee    | 361158        |
| 08/15/07 <sup>F</sup>         | FARS                   | Duanesburg         | I-88                      | 1             | 1993 Grand Cherokee    | 360655        |
| 06/19/08 <sup>F</sup>         | FARS                   | Churubusco         | River Rd.                 | 1             | 2004 Grand Cherokee    | 360417        |

| Crash Date by State        | Name   | City/County    | Road                            | Deaths | Make/Model/Year     | FARS # |
|----------------------------|--|----------------|---------------------------------|--------|---------------------|--------|
| 01/26/09 <sup>F</sup>      | Arthur Reece, Larissa<br>Reece, Delano<br>Anderson | Islip          | I-495                           | 3      | 1995 Grand Cherokee | 360030 |
| <b>North Carolina</b>      |  |                |                                 |        |                     |        |
| 12/19/99**                 | FARS (tree)  | Columbus Co.   | US-74-76                        | 1      | 1994 Grand Cherokee | 371297 |
| 03/09/02*†(2)              | FARS   | Nash Co.       | US-64                           | 2      | 1998 Grand Cherokee | 370211 |
| 12/03/10*                  | FARS (tree)  | Edgecombe Co.  | RP-1223                         | 1      | 1994 Grand Cherokee | 371134 |
| <b>North Dakota</b>        |  |                |                                 |        |                     |        |
| 07/24/06**                 | FARS (overturn)                                    | Stark Co.      | SR-10 114 <sup>th</sup> Ave. SW | 1      | 1993 Grand Cherokee | 380051 |
| <b>Ohio</b>                |  |                |                                 |        |                     |        |
| 07/30/95**                 | FARS (culvert)                                     | Hilliard       | Hayden Run Road                 | 1      | 1993 Grand Cherokee | 390650 |
| 09/26/97 <sup>F</sup>      | FARS   | Wood Co.       | SR65                            | 1      | 1993 Grand Cherokee | 390948 |
| 09/05/98*                  | FARS   | Delaware Co.   | US-42                           | 1      | 1996 Grand Cherokee | 390810 |
| 12/17/98*                  | FARS   | Guernsey Co.   | I-70                            | 1      | 1993 Grand Cherokee | 391178 |
| 11/23/99*†(2)              | FARS   | Tuscarawas Co. | I-77                            | 2      | 1996 Grand Cherokee | 391139 |
| 03/24/01**                 | FARS (tree)  | Chillicothe    | Bellevue Ave.                   | 1      | 1996 Grand Cherokee | 390067 |
| 06/29/02*                  | FARS   | Sandusky Co.   | SR-600                          | 1      | 1997 Grand Cherokee | 390544 |
| 05/28/03*†(1)              | FARS   | Lawrence Co.   | SR-378                          | 1      | 1998 Grand Cherokee | 390409 |
| 11/29/03*                  | FARS   | Lakeview       | US-33                           | 1      | 1999 Grand Cherokee | 391018 |
| <b>Oklahoma</b>            |  |                |                                 |        |                     |        |
| 05/26/01 <sup>F</sup> †(1) | FARS   | Oklahoma City  | S. Choctaw Rd.                  | 2      | 1993 Grand Cherokee | 400185 |
| <b>Oregon</b>              |  |                |                                 |        |                     |        |
| 09/22/95*                  | FARS   | Grant Co.      | 5                               | 1      | 1993 Grand Cherokee | 410353 |
| 09/20/97**                 | FARS (overturn)                                    |                | 205/DOT440                      | 2      | 1994 Grand Cherokee | 410303 |
| <b>Pennsylvania</b>        |  |                |                                 |        |                     |        |
| 10/24/98**                 | FARS (tree)  | Franklin Co.   | I-76                            | 2      | 1998 Grand Cherokee | 421049 |
| 03/05/00 <sup>F</sup>      | FARS   | Bucks Co.      | SR-309                          | 1      | 1993 Grand Cherokee | 420157 |
| 09/21/03*†(1)              | FARS   | Clinton Co.    | SR-120                          | 2      | 1994 Grand Cherokee | 421054 |
| 02/27/04*                  | FARS   | York Co.       | I-83                            | 2      | 2000 Grand Cherokee | 420293 |
| 07/03/05**                 | FARS (tree)  | Philadelphia   | SR-4013                         | 1      | 1993 Grand Cherokee | 420613 |
| 04/05/06**                 | FARS (overturn)                                    | Clarion Co.    | Nickleville Rd.                 | 1      | 1995 Grand Cherokee | 420249 |
| 11/30/06*                  | FARS   | Warren Co.     | SR-0059                         | 1      | 1995 Grand Cherokee | 421006 |
| 11/12/07*†(1)              | FARS   | Lackawanna Co. | SR-435                          | 1      | 2000 Grand Cherokee | 421144 |

| <b>Crash Date by State</b> | <b>Name</b>                             | <b>City/County</b> | <b>Road</b>                           | <b>Deaths</b> | <b>Make/Model/Year</b> | <b>FARS #</b> |
|----------------------------|---|--------------------|---------------------------------------|---------------|------------------------|---------------|
| 02/16/08**                 | FARS (tree)                             | Erie Co.           | SR-5                                  | 1             | 2002 Grand Cherokee    | 420105        |
| 08/02/10*                  | FARS (tree)                             | Greene Co.         | SR-1021                               | 1             | 2004 Grand Cherokee    | 420567        |
| <b>Rhode Island</b>        |   |                    |                                       |               |                        |               |
| 07/12/02**                 | FARS (tree)                             | Scituate           | SR-116                                | 1             | 1998 Grand Cherokee    | 440023        |
| <b>South Carolina</b>      |   |                    |                                       |               |                        |               |
| 08/06/99 <sup>F</sup>      | FARS                                    | Marlboro Co.       | 259                                   | 2             | 1993 Grand Cherokee    | 450527        |
| 05/21/00 <sup>F</sup>      | FARS                                    | Hampton            | SR-68                                 | 1             | 1994 Grand Cherokee    | 450396        |
| 12/17/03** <sup>F-A</sup>  | Bennett Hartsel, Brett Jones (overturn) | Johns Island       | River Road                            | 2             | 2002 Grand Cherokee    | 450884        |
| 04/25/05*                  | FARS                                    | Richland Co.       | I-20 SR-277                           | 1             | 1998 Grand Cherokee    | 450360        |
| 07/07/08 <sup>F</sup>      | FARS                                    | Georgetown Co.     | US-17 545                             | 1             | 1996 Grand Cherokee    | 450425        |
| <b>South Dakota</b>        |   |                    |                                       |               |                        |               |
| 03/23/07**                 | FARS (overturn)                         | Moody Co.          | SR-34                                 | 1             | 1998 Grand Cherokee    | 460021        |
| <b>Tennessee</b>           |   |                    |                                       |               |                        |               |
| 08/31/01 <sup>F</sup>      | FARS                                    | Jackson            | McClellan Rd.                         | 1             | 1999 Grand Cherokee    | 470731        |
| 08/31/02 <sup>F</sup>      | FARS                                    | Lawrence Co.       | Old Jackson Hwy.                      | 1             | 1994 Grand Cherokee    | 470669        |
| 05/29/04 <sup>F</sup>      | FARS                                    | Germantown         | Stout Rd.                             | 1             | 1996 Grand Cherokee    | 471036        |
| 08/01/05**                 | FARS (bridge pier)                      | Kingsport          | I-181                                 | 1             | 1997 Grand Cherokee    | 471107        |
| 11/18/06*†(1)              | FARS                                    | Wilson Co.         | Saundersville Rd. Cedar Creek Village | 1             | 1998 Grand Cherokee    | 471136        |
| 12/16/06**                 | FARS (tree)                             | Mount Juliet       | South Greenhill Rd.                   | 1             | 1999 Grand Cherokee    | 470904        |
| 03/19/09**                 | FARS (embankment)                       | Eads               | SR-205                                | 1             | 2004 Grand Cherokee    | 470443        |
| <b>Texas</b>               |   |                    |                                       |               |                        |               |
| 06/22/97*                  | FARS                                    | Cass Co.           | 59                                    | 1             | 1996 Grand Cherokee    | 481932        |
| 01/16/98 <sup>F</sup>      | FARS                                    | Brazoria Co.       | SR-288                                | 1             | 1994 Grand Cherokee    | 480087        |
| 11/11/00**                 | FARS (tree)                             | Gonzales Co.       | SR-97                                 | 1             | 1997 Grand Cherokee    | 482644        |
| 06/09/04 <sup>F</sup>      | FARS                                    | Victoria Co.       | US-77                                 | 1             | 2002 Grand Cherokee    | 481205        |
| 12/12/04*†(1)              | FARS                                    | Dallas             | I-35E                                 | 1             | 1998 Grand Cherokee    | 483248        |
| 08/06/05 <sup>F</sup>      | FARS                                    | Bullard            | FM344                                 | 1             | 1996 Grand Cherokee    | 481685        |
| 02/12/06* <sup>F-A</sup>   | Cassidy Jarmon                          | Cleburne           | SR-174                                | 1             | 1993 Grand Cherokee    | 480273        |
| 04/28/06*                  | FARS                                    | Dallas             | I-30                                  | 2             | 2000 Grand Cherokee    | 480867        |
| 7/10/09 <sup>F</sup>       | Rodney Wood                             | Fort Worth         | NE Loop 820                           | 1             | 2004 Grand Cherokee    | 481432        |

| <b>Crash Date by State</b> | <b>Name</b>     | <b>City/County</b> | <b>Road</b>               | <b>Deaths</b> | <b>Make/Model/Year</b> | <b>FARS #</b> |
|----------------------------|-----------------|--------------------|---------------------------|---------------|------------------------|---------------|
| 12/31/10*                  | FARS (post)     | Anderson Co.       | FM2054                    | 1             | 1999 Grand Cherokee    | 482581        |
| <b>Vermont</b>             |                 |                    |                           |               |                        |               |
| 04/10/00*                  | FARS            | Swanton            | I-89                      | 1             | 1998 Grand Cherokee    | 500019        |
| 09/11/08*                  | FARS            | Waterbury          | SR-100                    | 1             | 1998 Grand Cherokee    | 500049        |
| 06/01/09*†(1)              | FARS            | Saint Albans       | US-7 and Jewett Ave.      | 1             | 1998 Grand Cherokee    | 500025        |
| <b>Virginia</b>            |                 |                    |                           |               |                        |               |
| 08/08/03*                  | FARS            | Washington Co.     | SR-75                     | 1             | 1998 Grand Cherokee    | 510627        |
| <b>Washington</b>          |                 |                    |                           |               |                        |               |
| 03/15/06**                 | FARS (tree)     | Auburn             | SR-164                    | 2             | 1995 Grand Cherokee    | 530101        |
| 12/06/09 <sup>F</sup>      | James R. Smith  | Okanogan           | Rendezvous Rd.            | 1             | 2003 Grand Cherokee    | 530405        |
| <b>West Virginia</b>       |                 |                    |                           |               |                        |               |
| 12/06/03**                 | FARS (tree)     | Kanawha Co.        | US-60                     | 1             | 1994 Grand Cherokee    | 540342        |
| 09/30/06 <sup>F</sup>      | FARS            | Charleston         | Hickory Rd. Overbrook Rd. | 1             | 1998 Grand Cherokee    | 540269        |
| <b>Wisconsin</b>           |                 |                    |                           |               |                        |               |
| 05/18/03 <sup>F</sup>      | FARS            | Grant Co.          | SR-133                    | 1             | 1996 Grand Cherokee    | 550248        |
| 07/03/04**                 | FARS (tree)     | Columbia           | Hopkins Rd.               | 1             | 1995 Grand Cherokee    | 550318        |
| 07/03/07 <sup>F</sup>      | Stacy Mayer     | Nashotah           | SR-16                     | 1             | 2001 Grand Cherokee    | 550300        |
| 09/09/07**                 | FARS (overtake) | Greenfield         | I-43                      | 1             | 1994 Grand Cherokee    | 550455        |
| 10/21/09**                 | FARS (tree)     | Rock Co.           | US-14                     | 1             | 2007 Grand Cherokee    | 550391        |
| <b>Wyoming</b>             |                 |                    |                           |               |                        |               |
| 04/04/03*                  | FARS            | Converse Co.       | I-25                      | 1             | 1993 Grand Cherokee    | 560022        |

<sup>F</sup> Indicated in FARS as most harmful: "fire/explosion."

\* Indicated in FARS as most harmful: "motor vehicle in transport" or "motor vehicle in transport in other roadway."

\*\* Item in parentheses is most harmful event as indicated in FARS.

<sup>F-A</sup> Fire listed as cause of death in autopsy report or death certificate.

<sup>F-L</sup> Fire indicated as cause of death in litigation.

<sup>F-R</sup> Fire indicated as cause of death in accident report.

† Fatality(s) (#) occurred in bullet vehicle



# Tab F

National Automobile Dealers Association

*Ethics Guide*

Automotive News – NADA Convention Coverage

*Marchionne thanks dealers, demands more from them*



## National Automobile Dealers Association

### Ethics Guide



In addition to the Code of Ethics poster, NADA has published an Ethics Guide that focuses on four key areas of dealership operations: sales, service, financial services and advertising:

#### 1. ADVERTISING

This dealership is committed to advertising its products and services in a clear, conspicuous and accurate manner that fully complies with applicable legal requirements. This includes disclosing credit terms in accordance with the federal Truth in Lending Act and consistent with state and local law.

#### 2. FINANCIAL SERVICES

Implicit in these standards is the requirement that NADA members comply fully with all federal, state, and local laws governing their businesses.

At this dealership, the finance and insurance professionals will at all times...

- Disclose fully to customers the costs, terms, and contractual obligations of credit and lease transactions. Documents will be written in a simple, plain, and unambiguous manner to the extent permitted by federal and state law.
- Offer optional insurance or other optional products in a clear and informative manner. Any purchase of such a product must reflect a voluntary choice by the consumer.
- Advertise financial services products in a clear and non-deceptive manner.

#### 3. SALES

Implicit in these standards is the requirement that NADA members comply fully with all federal, state, and local laws governing their businesses.

At this dealership, the sales professionals will at all times...

- Embrace the spirit and the letter of the law governing the retail sales of new and used vehicles.
- Be honest and truthful when dealing with customers.
- Have a thorough knowledge of the product and be able to apply that knowledge to help satisfy the transportation needs of the customers.
- Provide each customer with a thorough and clear explanation of the steps involved in the purchase or lease of a vehicle and follow those steps diligently.
- Always treat each customer in a professional manner.
- Be responsible for the prompt performance of post-sale administrative and delivery procedures.

- Represent the dealership and the automobile industry in a professional manner.

#### 4. SERVICE

Implicit in these standards is the requirement that NADA members comply fully with all federal, state, and local laws governing their businesses.

At this dealership, the service professionals will at all times...

- Perform high quality repair service at a fair and competitive price.
- Employ trained and skilled technicians.
- Furnish an itemized invoice for parts and services that clearly identifies any used or remanufactured parts. Replaced parts may be inspected upon request.
- **Have a sense of personal obligation to each customer.**
- When appropriate, recommend corrective and maintenance services, explaining to the customer which of these are required to correct existing problems and which are for preventive maintenance.
- Provide each customer a price estimate for work to be performed, upon request, or as required by law.
- Make available copies of any warranties covering parts or services.
- Obtain prior authorization for all work done.
- Notify the customer if appointments or completion promises cannot be kept.
- Maintain customer service records as required by law.
- Exercise reasonable care for the customer's property while in the dealership's possession.
- Maintain a system to provide for a prompt response to all customer complaints.
- Uphold the highest standards of service in our profession.

#### Purchase Ethics Guide Online

The Ethics Guide pamphlet is available for purchase by NADA members in bulk quantities of 25 pamphlets. To purchase online [click here](#), or contact NADA Management Education at (703) 821-7227, or e-mail: [me@nada.org](mailto:me@nada.org).

[Return to Code of Ethics page](#)

# Automotive News

NADA CONVENTION

## Marchionne thanks dealers, demands more from them

**Larry P. Vellequette**

Automotive News | February 13, 2012 - 12:01 am EST

LAS VEGAS -- Chrysler-Fiat CEO Sergio Marchionne struck a conciliatory tone with dealers here last week. He thanked them for Chrysler Group's success and acknowledged that automakers no longer had the power to dictate terms to their retailing partners.

But the CEO also pointedly reminded dealers of the bargain that Chrysler Group had proposed to them in October 2010 in Orlando. There, Marchionne had promised that Chrysler would spend to improve its products if dealers improved the way they treated customers. And it was clear in Las Vegas that his patience was wearing thin.

"The exchange of a promise for a promise holds as true as ever," Marchionne, 59, told dealers during a surprise appearance at their Sunday morning make meeting at the National Automobile Dealers Association convention. "We are doing everything in our power to deliver on our promise. And I expect you to do the same."



Sergio Marchionne:  
Dealers sell cars, not  
Chrysler.

*Photo credit:*  
JOE WILSSENS

Chrysler Group suspended the rewards portion of its Dealer Standards program effective Jan. 1. The automaker said that the program had been successful in improving facilities but that customer-satisfaction scores had plateaued.

The automaker intends to rework the plan but has offered few details.

He also stared down the legislative stand of his hosts at the NADA convention, to whom he delivered the keynote welcome address on Saturday, Feb. 4. He called out NADA's opposition to the federal government's proposed 54.5-mpg standard for corporate fleets by 2025.

"This standard is 14 years out," he told reporters after delivering his 30-minute address. "If you start giving up on projects that are 14 years out, we might as well choose another occupation."

Because Marchionne was the only global auto CEO at the NADA convention, his appearance and comments put Chrysler Group center stage through much of the four-day event.

"It was great. Sergio was very focused," said Mark Greene, general manager of Lynch Chrysler-Dodge-Jeep-Ram in



East Troy, Wis.

Craig Sigurdson, owner of Urban Sales & Service, a Chrysler-Dodge-Jeep-Ram dealership in Neillsville, Wis., agreed: "Everybody's really happy with his performance."

During his appearances, Marchionne also said:

-- Chrysler would maintain flexibility and transparency as it overhauls its suspended Dealer Standards program, saying all automakers "have to go beyond a system where the manufacturer issues top-down edicts" to dealers.

-- Pricing information now on the Internet means "price negotiating is being taken out of [dealers'] hands, and it is a trend that will only continue."

-- The praise that Chrysler has received for lifting sales is partly misdirected. "The truth is that Chrysler itself didn't sell a single car to consumers. It was Chrysler dealers who moved the metal, one vehicle at a time."

-- Chrysler will begin offering compressed natural gas-fueled vehicles, especially commercial ones, to gauge interest among consumers. "I can make them faster than you can think, but you have to have people that are going to buy them."



Several Chrysler Group executives and scores of dealers watch as Chrysler's "Halftime in America" commercial, featuring Clint Eastwood, is broadcast during the Super Bowl. The group was attending Chrysler's dealer reception during the convention.

*Photo credit: JOE WILSSENS*

PRINTED FROM: <http://edit.autonews.com/apps/pbcs.dll/article?AID=/20120213/RETAIL07/302139966&template=printart>

# Tab G

**Summary of Performance Appraisal Comments filed by Chrysler Executives,  
just prior to Office raid and *ex parte* dismissal and *ex parte* “muzzle order”  
during Christmas holidays of 1994**

**Subject: Former Chairman of the Safety Leadership Team (SLT), Paul V. Sheridan**

**Summary of Performance Appraisal Comments  
Filed by Chrysler Executives  
Covering a Two Year Evaluation Period**

**Subject: Paul V. Sheridan  
Reference: Minivan Safety Leadership Team**

*"Paul (Sheridan) does a thorough, detailed, organized, and tireless job. He became an active promoter of advancing safety in the (minivan) program only slowing when the reality of the interest from management became apparent to him..."*

Ronald S. Zarowitz  
Manager, Safety Office, (810) 576 - 7305  
October 10, 1994

*"(Paul Sheridan) has directed various team efforts well, with a strong goal orientation, especially the (minivan) Safety Leadership Team..."*

Mark W. Clemons  
Manager, Chrysler-Plymouth Marketing, (313) 956 - 3763  
October 14, 1994

*"Overall I think Paul (Sheridan) has done an excellent job...He has been eager to get involved...Always very open and candid...good planning skills...Good team leader..."*

Bernard E. Swanson  
Executive Engineer-Minivan Platform  
October 16, 1994, (810) 576 - 2908

*"Paul (Sheridan) did a good job as Chairman of the Minivan Safety Leadership Team...He brings a valuable engineering perspective to his product planning role...He is willing to speak up when he disagrees, which is good..."*

Scott A. Sullivan  
Manager, Market Research  
October 12, 1994

*"I find (Paul Sheridan) to be very innovative and certainly not afraid to push the envelope. His professional yet open demeanor easily wins the respect of his colleagues. He is extremely knowledgeable, and may well be one of the best all around technical persons on staff...Paul is a valuable asset to the (minivan) platform and I rely on him to accomplish our mutual goals"*

Paul T. Doolan  
Engineering Programs Manager-Minivan  
October 10, 1994, (810) 576 - 4837

# MULTIPLE INPUT FORM - CONFIDENTIAL

The use of this form is optional. If it is used, however, the guidelines on the back of this form must be followed. Multiple input can provide supervisors with valuable, additional information to consider when completing employee appraisals and development plans. Your input regarding the employee's past year's results and behaviors is appreciated.

Employee Name Paul Sheridan Date 10-10-94  
Provider Name (Optional) Ron Zarowitz How Long Have You Worked with the Employee? 2 years  
Relationship to Employee:  
 Customer  Supplier  Team Member  Subordinate  Peer  Other \_\_\_\_\_

## RESULTS:

Please provide a brief summary of the employee's success or difficulty in fulfilling his or her job duties related to you. Include specific examples and results.

Paul does a thorough, detailed, organized, and tireless job. He became an active promoter of advancing safety in the NS program, only slowing when the reality of the interest from management became apparent to him. He created & led NS SLT to point of making data-based recommendations to NS management.

## BEHAVIORS:

Please list areas where you feel the employee excels or has opportunity for development. Keep in mind the following behaviors:

Innovation/Risk Taking Continuously attempts to push forward/try something new/ be inventive.

Teamwork Very interested in team dynamics consensus-building - good leader.

Encouraging/Valuing Diversity Different backgrounds/points-of-view sought out, encouraged.

Communication/Openness/Candor Direct, honest, to the point of being blunt

Continuous Process Improvement (no basis to evaluate)

Planning/Priority Setting Organized NS SLT & ran group effectively/efficiently. Developed plan to prioritize group objectives.

Problem Solving Creative, up to point of "hitting the wall" - then process steps.

Leadership - good. encourages group input - leads group to make progress - has vision of ultimate goal.

Customer Responsiveness [no basis to evaluate]

Technical Expertise

People Management/Development (for supervisors only)

**OTHER COMMENTS OR CONCERNS:** Very strong candidate who could work on achieving "grace under fire" - temper sometimes comes through too quickly when frustrated.

Please return to Dennis Malecki by \_\_\_\_\_  
Name Date

Thanks!



# MULTIPLE INPUT FORM - CONFIDENTIAL

The use of this form is optional. If it is used, however, the guidelines on the back of this form must be followed. Multiple input can provide supervisors with valuable, additional information to consider when completing employee appraisals and development plans. Your input regarding the employee's past year's results and behaviors is appreciated.

Employee Name **Paul Sheridan**

Date **October 14, 1994**

Provider Name **Mark Clemons**

How long have you worked with the Employee? **2 Years**

Relationship to Employee:

Customer

Supplier

Team Member

Subordinate

Peer

Other

## RESULTS:

Please provide a brief summary of the employee's success or difficulty in fulfilling his or her job duties related to you. Include specific examples and results.

**Paul has been successful in his duties, especially with the NS teams that he chairs. He is also an enthusiastic team member.**

## BEHAVIORS:

Please list areas where you feel the employee excels or has opportunity for development. Keep in mind the following behaviors:

Innovation/Risk Taking

Teamwork

**Good team player. Assumes team goals well and works aggressively to accomplish team objectives.**

Encouraging/Valuing Diversity

**Paul is aggressive, opinionated and persistent, traits which can be assets when moderated. However, he occasionally allows his personal views to compromise his effectiveness.**

Communication/Openness/Candor

**Clear and concise. Expresses views well, both orally and written.**

Continuous Process Improvement

Planning/Priority Setting

**Has directed various team efforts well, with a strong goal orientation (especially the NS Safety Leadership Team leading up to the NS safety research).**

Problem Solving

**Good analytical skills. Researches issues well. Brings facts to bear for decision making purposes.**

Role Model Behavior/Leadership

**Effective in chairing NS Safety Leadership, NS Complexity and NS Exterior Ornamentation teams. Leads discussions well and assists teams in developing necessary outputs.**

Customer Responsiveness

**Keeps commitments to teams and team members.**

Technical Expertise

**Displays good understanding relating to chassis items and exterior ornamentation.**

People Management/Development (for supervisors only)

## OTHER COMMENTS OR CONCERNS:

Please return to **Dennis Malecki**

by **October 19, 1994**

Name

Date

THANKS!



Good Team Player, Has Done Well. His Job Requires It.

# MULTIPLE INPUT FORM - CONFIDENTIAL

The use of this form is optional. If it is used, however, the guidelines on the back of this form must be followed. Multiple input can provide supervisors with valuable, additional information to consider when completing employee appraisals and development plans. Your input regarding the employee's past year's results and behaviors is appreciated.

Employee Name Paul Sheridan Date 10-16-94  
Provider Name (Optional) B. E. SWANSON How Long Have You Worked with the Employee? 2+ YRS.  
Relationship to Employee:  
 Customer  Supplier  Team Member  Subordinate  Peer  Other

### RESULTS:

Please provide a brief summary of the employee's success or difficulty in fulfilling his or her job duties related to you. Include specific examples and results.

OVERALL I THINK PAUL HAS DONE AN EXCELLENT JOB IN CHAMPIONING REDUCTION IN COMPLEXITY. FROM A CHASSIS PERSPECTIVE, HE HAS BEEN EAGER TO GET INVOLVED IN ISSUES PRESENTED TO HIM. SOMETIMES IT APPEARS HE TAKES ISSUES AS MORE OF A "PERSONAL CRUSADE" RATHER THAN AN "EXPOSE THE BUSINESS ISSUES" FOCUS WHICH I THINK FRUSTRATES HIM WHEN HIS VIEW IS NOT ACCEPTED OR ACTIONED ON. THIS DOES NOT APPEAR TO AFFECT HIS EFFECTIVENESS, HOWEVER, AS A SOURCE OF FRUSTRATION TO HIM.

- BEHAVIORS:** Please list areas where you feel the employee excels or has opportunity for development. Keep in mind the following behaviors:
- Innovation/Risk Taking: DOES NOT APPEAR TO AFFECT HIS EFFECTIVENESS, HOWEVER, AS A SOURCE OF FRUSTRATION TO HIM.
  - Teamwork
  - Encouraging/Valuing Diversity
  - Communication/Openness/Candor - ALWAYS VERY OPEN AND CANDID WITH VME.
  - Continuous Process Improvement
  - Planning/Priority Setting: DEMONSTRATES GOOD PLANNING SKILLS.
  - Problem Solving
  - Leadership: TAKE INITIATIVE TO ADDRESS ISSUES. LEADS THE CHARGE
  - Customer Responsiveness: HAS BEEN VERY RESPONSIVE TO CHASSIS ISSUES.
  - Technical Expertise: ADEQUATE TO MORE THAN ADEQUATE FOR CHASSIS.
  - People Management/Development (for supervisors only)

### OTHER COMMENTS OR CONCERNS:

PAUL HAS A TENDENCY TO GAMBOL ABOUT THINGS WHICH I THINK IS MOSTLY A "PERSONALITY" THING.

Please return to Dennis Malecki by \_\_\_\_\_  
Name Date

Thanks! DENNIS, SORRY ABOUT THE QUANTITY OF MY WRITTEN RESPONSE. I WOULD BE GLAD TO DISCUSS PAUL WITH YOU. PLEASE LET ME KNOW IF YOU HAVE ANY COMMENTS.

# MULTIPLE INPUT FORM - CONFIDENTIAL

The use of this form is optional. If it is used, however, the guidelines on the back of this form must be followed. Multiple input can provide supervisors with valuable, additional information to consider when completing employee appraisals and development plans. Your input regarding the employee's past year's results and behaviors is appreciated.

Employee Name Paul Sheridan Date 10/12/94  
Provider Name (Optional) SCOTT SULLIVAN How Long Have You Worked with the Employee? 15 MONTHS  
Relationship to Employee:  
 Customer  Supplier  Team Member  Subordinate  Peer  Other \_\_\_\_\_

## RESULTS:

Please provide a brief summary of the employee's success or difficulty in fulfilling his or her job duties related to you. Include specific examples and results.

PAUL DID A GOOD JOB AS CHAIRMAN OF THE MINIVAN SAFETY LEADERSHIP TEAM DURING THE TIME I WORKED WITH THAT GROUP. HE ACTIVELY PARTICIPATES IN THE PST DISCUSSIONS, AND HE BRINGS A VALUABLE ENGINEERING PERSPECTIVE TO HIS PRODUCT PLANNING ROLE.

## BEHAVIORS:

Please list areas where you feel the employee excels or has opportunity for development. Keep in mind the following behaviors:

Innovation/Risk Taking - HE IS WILLING TO SPEAK UP WHEN HE DISAGREES, WHICH IS GOOD.

Teamwork

Encouraging/Valuing Diversity

Communication/Openness/Candor - HIS ARGUMENTS ARE, AT TIMES, A BIT TOO EMOTIONAL. THIS CAN WORK AGAINST HIM IN TRYING TO CONVINCE OTHERS.

Continuous Process Improvement

Planning/Priority Setting - IN A FEW INSTANCES WITH THE SAFETY LEADERSHIP TEAM PAUL GOT BOGGED DOWN IN DETAILS WHEN THE GROUP WAS READY TO MOVE FORWARD.

Problem Solving

Leadership

Customer Responsiveness

Technical Expertise

People Management/Development (for supervisors only)

## OTHER COMMENTS OR CONCERNS:

Please return to Dennis Malecki by \_\_\_\_\_  
Name Date

Thanks!



# MULTIPLE INPUT FORM – CONFIDENTIAL

The use of this form is optional. If it is used, however, the guidelines on the back of this form must be followed. Multiple input can provide supervisors with valuable, additional information to consider when completing employee appraisals and development plans. Your input regarding the employee's past year's results and behaviors is appreciated.

Employee Name Paul Sheridan Date 10/10/94  
Provider Name (Optional) PAUL DOCLAN How Long Have You Worked with the Employee? \_\_\_\_\_  
Relationship to Employee:  
 Customer  Supplier  Team Member  Subordinate  Peer  Other \_\_\_\_\_

## RESULTS:

Please provide a brief summary of the employee's success or difficulty in fulfilling his or her job duties related to you. Include specific examples and results.

*Some specific examples of Paul's contributions include: tie & wheel plan, suspension complexity reduction matrix, powertrain plan, tie & wheel volumes, and recently exterior ornamentation items.*

## BEHAVIORS:

Please list areas where you feel the employee excels or has opportunity for development. Keep in mind the following behaviors:

Innovation/Risk Taking  
Teamwork  
Encouraging/Valuing Diversity  
Communication/Openness/Candor  
Continuous Process Improvement  
Planning/Priority Setting  
Problem Solving  
Leadership  
Customer Responsiveness  
Technical Expertise  
People Management/Development (for supervisors only)

*As a fellow member on several teams with Paul, I find him to be very innovative and certainly not afraid to push the envelope. His professional yet open demeanor easily wins the respect of his colleagues. He is extremely knowledgeable, and may well be one of the best all around technical persons on staff. He is detail oriented, and works hard at his craft. His work on complexity reduction demonstrates good planning and problem solving skills. He is also a very capable communicator, both written and verbal, and appears well organized.*

## OTHER COMMENTS OR CONCERNS:

*Paul is a valuable asset to the platform, and I rely on him to accomplish our mutual goals.*

Please return to Dennis Malecki by \_\_\_\_\_  
Name Date

Thanks!

# Tab H

**Affidavit and Deposition of Garrity Motors General Manager Mr. Seymour Kliger**

**Subject: Identified by Chrysler Corporation merely as "John Doe" in their *ex parte* lawsuit against Paul V. Sheridan of 27 December 1994  
(Please see Tab G)**

STATE OF MICHIGAN

IN THE CIRCUIT COURT FOR THE COUNTY OF OAKLAND

CHRYSLER CORPORATION,  
a Delaware corporation,

Plaintiff,

vs.

PAUL SHERIDAN,

Defendant.

C.A.#94-48917-CZ  
HON. EDWARD SOSNICK

Charles F. Clippert (P11938)  
Attorney for Plaintiff  
525 North Woodward Avenue  
Bloomfield Hills, MI 48303-0509  
(810) 646-4300

Joseph C. Marshall, III (P28079)  
Robert B. Brown (P51378)  
Attorneys for Plaintiff  
500 Woodward Ave., Suite 4000  
Detroit, MI 48226  
(313) 223-3500

Courtney E. Morgan, Jr. (P29137)  
Attorney for Plaintiff  
1490 First National Building  
Detroit, Michigan 48226  
(313) 961-0130

AFFIDAVIT OF SEYMOUR KLIGER

STATE OF MICHIGAN)

COUNTY OF Washtenaw) ss.

I, SEYMOUR KLIGER, being first duly sworn, depose and say:

1. My name is Seymour Kliger. I am a resident of the State of Michigan. I am over the age of 21.

2. I am the General Manager of Garrity Motor Sales, Inc., located at 11500 Joseph Campau, Hamtramck, MI 48212. I have been associated with the automobile business since 1952 and have been the General Manager of Garrity Motors Sales, Inc. (hereinafter known as "Garrity Motors") since it opened in 1959.

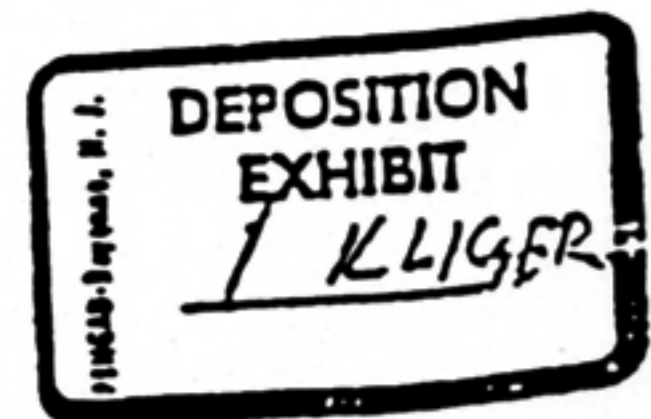
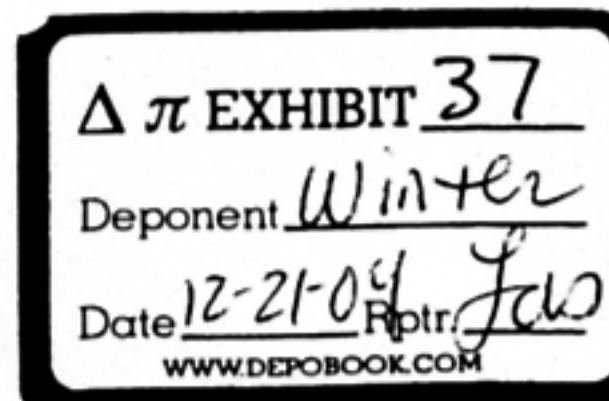



LAW OFFICES • CHAMBERS SYDNER • A PROFESSIONAL CORPORATION

3. Garrity Motors is the closest Dodge Dealership to Chrysler Motor Headquarters located in Highland Park, MI. Additionally, there are many plants of the Chrysler Corporation in the near vicinity to Garrity Motors.

4. Through my employment with Garrity Motors, I have become acquainted with many Chrysler Corporation executive employees and officers of the Corporation.

5. My associations with such persons have been both personal and professional.

6. By way of example, the following is a partial list of present and/or former Chrysler Corporation employees with whom I have communicated either orally or in writing on a wide range of subject matters in the past: Lee A. Iacocca, Gerald Greenwald, Robert Lutz, Hal Sperlich, R. S. Miller, Jack Withrow, John Naughton, Gar Laux, Gino Giccondi, Jerry York, Martin Levine and Richard Dauch.

7. As indicated, I have had discussions with these and other employees regarding a wide range of subject matters related to Chrysler's business, including information of a potentially confidential and/or sensitive nature to the Corporation. I have also exchanged documents with at least some of these persons in connection with said discussions. A partial list of the subject matters over which I have had discussion or exchanged documents includes the following: sales, marketing, product planning, complexity, warranty, product liability, manufacturing, communications, customer relations and personnel.

8. I have done these things with one reward in mind -- that the Chrysler Corporation receive the sales, profit, and market share that is rightfully theirs. This principle has and will guide me in all my endeavors related to Chrysler Corporation.

9. I am acquainted with Paul Sheridan. I first met him through sales contacts at Garrity Motors and have known him for several years. I have sold vehicles to him and many of his acquaintances based upon Mr. Sheridan's recommendations. I have also interacted with Mr. Sheridan regarding certain matters related to Chrysler Corporation's business in much the same manner as I have interacted with other Chrysler employees as set forth in paragraph 6 of this Affidavit.

10. I am also acquainted with Joseph Eohn, a writer for the Automotive News. I have always considered his journalistic integrity towards the Chrysler Corporation to be of the highest order.

11. On February 7, 1995, I was served with a subpoena for my deposition to be taken in the case of Chrysler Corporation v Paul Sheridan. Attached to said subpoena, was a copy of Chrysler's Verified Complaint and certain attachments including Affidavits of Martin Levine, John M. Fonger, Michael J. Krotche, Dennis C. Malecki and Mark W. Crossman.

12. I understand that Chrysler Corporation has identified me as a third party ("John Doe"), to whom Paul Sheridan allegedly gave crash test information referred to in paragraphs 7, 8, 9 and 10 of Chrysler's Verified Complaint. I also understand that Chrysler Corporation alleges that I am the third party referred to in paragraph 10 of its Verified Complaint, who gave crash test documents to Joseph

Bohn at the Automotive News.

13. These allegations are untrue. I neither received from Paul Sheridan any crash tests results, nor transmitted or gave to Joseph Bohn any copies of any crash tests results documents.

14. Chrysler's Verified Complaint is dated December 27, 1994. At no time prior to that date was I ever contacted by anyone from Chrysler Corporation, claiming in any way to be investigating this matter or who asked me any questions which would in any way relate to my alleged role in this case. Had I been contacted by any Chrysler investigator, I would have freely shared with them all of the information which is contained in this Affidavit.

15. On February 8, 1995, I had a brief conversation with Joseph C. Marshall, III, attorney for Chrysler Corporation in this matter. Our conversation concerned the rescheduling of my deposition to be taken in this case. During the course of said conversation, which I initiated, I indicated to Mr. Marshall that I did not believe a subpoena was necessary and that I have always been willing to discuss these matters or, indeed, anything related to Chrysler with him or any Chrysler investigator or attorney at any time. Mr. Marshall replied that he had not contacted me because he did not know how to contact me. This statement by Mr. Marshall is untrue. I am personally acquainted with many attorneys employed by Chrysler Corporation including Leroy Ritchie, their Vice-President for Legal Affairs. I am also acquainted with Michael J. Krotzke whose Affidavit is attached to Chrysler's Verified Complaint in this case. I am quite certain that if Chrysler's legal staff or investigators wanted to speak with me at

LAW OFFICES • CHAMBERS STEINER • A PROFESSIONAL CORPORATION

any time regarding Paul Sheridan, or any other matter, they knew exactly where to find me, i.e., at Garrity Motors, phone number: 313-893-8300.

16. Mr. Sheridan has confided in me several concerns he has regarding the safety of Chrysler's minivans. Mr. Sheridan has expressed to me frustration over his inability to convince Chrysler management to act upon these concerns. Mr. Sheridan stated words to the effect that he should directly report to governmental agencies vehicle defects or other potential violations of the law. I suggested that he consider direct or indirect approaches to Mr. Robert Eaton, the current Chairman of Chrysler Corporation. At no time, did any option I discussed with Mr. Sheridan include direct or indirect approaches to any member of the press or other media.

FURTHER, DEPONENT SAITH NOT.

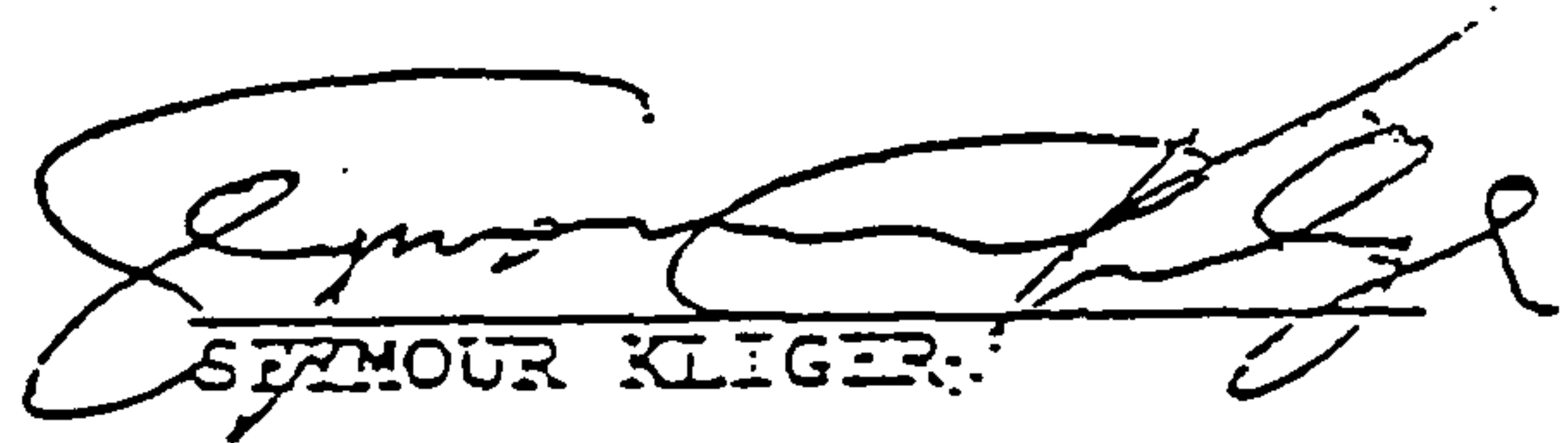
  
SEYMOUR KLIGER

Subscribed and sworn to before me  
this 10th day of FEBRUARY  
1995  
Thomas F. Tinkovsk  
NOTARY PUBLIC

My Commission Expires 12/31/97  
Marysville, Liberty County, MI



(1) Q: In this Complaint, it is alleged that Mr.  
(2) Sheridan gave a crash test document to a third  
(3) party?

(4) A: Well, it sure as hell wasn't me. I can tell you  
(5) that.

(6) MR. MORGAN: Mr. Marshall, I'm going to  
(7) ask you can you give us a copy of the alleged  
(8) crash test document that was given so I can show  
(9) it to the witness and verify that, in fact, he's  
(10) never seen it, and it was not given to him, and  
(11) he did not give it to Mr. Bohn?

(12) MR. MARSHALL: No.

(13) MR. MORGAN: You refuse to do that?

(14) MR. MARSHALL: I refuse to do it.

(15) MR. MORGAN: You want to keep that  
(16) secret, do you? You don't think I'm entitled to  
(17) the evidence in this case?

(18) MR. MARSHALL: Isn't this your  
(19) examination of this witness?

(20) MR. MORGAN: I'm asking you.

(21) MR. MARSHALL: I'm not —

(22) MR. MORGAN: I'm giving you an  
(23) opportunity, because you will be in front of the  
(24) Court, and you will have to explain your actions  
(25) in this case. I'm giving you an opportunity —

(1) month — and forty-three years I've been  
(2) associated with Chrysler — all with Dodge  
(3) thirty-six years of — virtually all forty-three  
(4) with the same company, and thirty-six years at  
(5) the same location, that this is the second time  
(6) in my life I've been deposed.

(7) The first time in my life when I was  
(8) deposed, it happened to involve an employee case,  
(9) again, which involved Mr. Cunningham. And at  
(10) that time, I called Mr. Greg Mazingo, and I  
(11) happened to have files because it was concerning  
(12) this velocity project, and I'll never forget. I  
(13) went right into Mr. Mazingo's office and took him  
(14) three cartons of documents — do you follow me —  
(15) on this velocity. And I said, "Greg, I want you  
(16) to know one thing. I'm on the side of what's  
(17) right. I'm on Chrysler's team. In this  
(18) particular case, Chrysler has done this wrong.  
(19) They have spent over — it's actually — I'm  
(20) going to say many millions because I don't want  
(21) to be challenged — but it was about forty  
(22) million dollars they paid to an outside  
(23) consulting agency at the rate of thirty-five  
(24) thousand three hundred per month, per consultant.  
(25) And virtually — like I say, Mr. Cunningham's

(1) MR. MARSHALL: I welcome the  
(2) opportunity to go in front of the Court. I can't  
(3) wait.

(4) MR. MORGAN: I'll bet.

(5) BY MR. MORGAN:

(6) Q: Mr. Kliger, the allegations in this Complaint  
(7) which allege that you received a document from  
(8) Mr. Sheridan, and that Mr. Sheridan — or that  
(9) you in turn gave the document regarding crash  
(10) test results to Mr. Bohn, are false allegations,  
(11) are they not, sir?

(12) A: They are totally untrue.

(13) THE WITNESS: Mr. Marshall, I'll just  
(14) tell you. Should I die where I'm sitting if I'm  
(15) lying to you. I never received any crash test  
(16) documents from Mr. Sheridan, nor did I pass — do  
(17) you follow me — any crash test documents to Mr.  
(18) Bohn.

(19) BY MR. MORGAN:

(20) Q: And Mr. Kliger, had anyone from Chrysler bothered  
(21) to ask you that before December 27, 1994, would  
(22) you have told them that you are not the source of

(23) A: Absolutely. This is the second time in my life  
(24) — and I'm going to be fifty-nine years old next

(1) actions with this particular employee at that  
(2) time, if you ever pull the files out — if you  
(3) call Greg Mazingo, Greg will tell you that I  
(4) walked in there just like I would have if you  
(5) would have called me or any investigator — if  
(6) Mr. Krotche would have called me, I would have  
(7) been over — do you follow me — immediately, or  
(8) talked to them — do you follow me — immediately  
(9) on this.

(10) So I mean, I wasn't hard to find, and I  
(11) really and truly — I feel almost insulted as to  
(12) the fact that if somebody from Chrysler wanted to  
(13) get me, including Mr. Ted Cunningham, they knew  
(14) where to go.

(15) BY MR. MORGAN:

(16) Q: Well, imagine how Mr. Sheridan feels.

(17) Mr. Kliger, we're going to stop the  
(18) questioning now because it is five o'clock. I  
(19) will take this up with you. We will pick another  
(20) appropriate date that is convenient to everyone's  
(21) schedule to complete this.

(22) A: Yes.

(23) Q: If you do find that file that you've referred to  
(24) here earlier today that you've been looking for  
(25) that contains correspondence from Chrysler which



# Tab I

Chrysler Times Article of 17 January 1991 entitled  
*“Critics Rave about Cummins Powered Ram Pickups”*

Chairman Lee A. Iacocca “To Be the Best” Chairman’s Award given to Paul V. Sheridan



# Critics rave about Cummins-powered Ram pickups

If a Dodge Ram outfitted with the Cummins 5.9-liter turbo diesel engine were to race a Ford or Chevy truck up a Colorado mountain road, there would be no question who would win. The Dodge Ram would sail up the mountain, while its Chevy and Ford counterparts chugged along in its dust.

In fact, in just about any endurance competition imaginable, the Dodge Ram truck would obliterate its competition.

This is not frivolous hype or propaganda generated by zealous marketing types. The example is based on testimonials by industry trade journals.

For instance, *Road Test Magazine* writes, "The Dodge-Cummins pickup outdistances its Ford and Chevy counterparts in every meaningful category."

"Dodgzilla" is a term coined by *Four Wheeler* magazine to describe the Dodge Ram pickup.

→ Why the acclaim? The engine powering the Dodge Ram—the Cummins diesel 5.9-liter six-cylinder turbo engine—has no equal, according to Paul Sheridan, Jeep®/Truck Engineering Engine Program Manager. It's the only factory-installed turbo diesel available in a pickup.

Referred to by Sheridan as the "Ferrari of the diesel engines," the Cummins is largely responsible for the recent success of Dodge Ram trucks in the marketplace.

The Cummins engine is in nearly half of all Dodge full-size pickup trucks sold. Dodge sold 30,000 turbo diesel pickups in the 1990 model year and projects sales of 44,000 units in 1991.

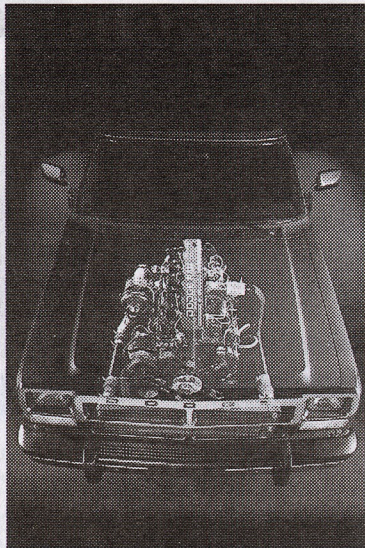

**The Cummins engine is in nearly half of all Dodge full-size pickup trucks sold. Dodge sold 30,000 turbo diesel pickups in the 1990 model year and projects sales of 44,000 units in 1991.**

"We are approaching 50 percent of Ford's volume after only three years in the diesel business," Sheridan added. "Our problem is not demand, but supply of available engines from Cummins. We can't fill customer orders fast enough."

The 1989 model year production was sold by December 1988, and 1990 production sold out by February 1990.

"We can't determine how great the demand is, because we haven't hit the ceiling yet," Sheridan said.

A diesel engine survey found that if given the option, one out of four Ford and General Motors diesel pickup buyers would pay an extra \$1,000 for a truck powered by a Cummins engine.

The engine was first used in the Dodge Ram full-size pickup



**Among the Cummins diesel team members who worked to ensure a smooth launch were, from left, Eugene Shensky, Product Change Analyst; Ken Scobel, Cummins On-Time Assembly; Walter Ralph, Vehicle Development Specialist; Troy Simonsen, Product Planning Manager; Greg Henderson, Design Aids Supervisor; and Paul Sheridan, Engine Programs Manager.**

trucks in 1989, but preparations to modify a Cummins diesel for the truck date back to 1985.

Eight Chrysler employees, part of the core Truck Operations group, approached the Cummins people namely because at the time the company was "the only game in town," Sheridan said. Ford was getting its diesel engines through Navistar, and General Motors manufactured its own and purchased some from Detroit Diesel.

Chrysler provided Cummins with a Dodge Ram truck and the assignment of making a Cummins diesel engine that could fit into the chassis.

## December 1990 Design Engineering/Manufacturing Cost Reduction Results

Cummins completed its assignment and the engine is now available in the Ram D-250 and D-350, both two- and four-wheel drive.

→ "We achieved this success over the years using a skeleton crew, minimal budget and a complicated but necessary release program," Sheridan said.

In addition to offering an engine intercooler to meet strict emissions standards, the 1991-1/2 model offers a four-speed automatic overdrive transmission that will boost the truck's current top speed of 80 mph and further improve its fuel economy and performance.

# Digest

## In the News

STANDARD & POOR'S placed the Big Three automakers on its CreditWatch list Jan. 9 because of a worsening economic picture.

Chrysler said, "We are, of course, disappointed... but given the difficult environment the industry is in, we can understand their concern. We know our minivans and sport utilities face increasing competition, but are confident that they remain the class of the field and able to withstand the assault."

Chrysler will have an opportunity to present its case to Standard & Poor's.

## Innovation

AL BARRETT, Mark Huber, Mike Larson, Don McCutcheon and Jim Pitt represented Chrysler in accepting an award from the Society of Automotive Plastics for the company's use of plastic in body interiors. In conjunction with Entech, Rockwell and General Electric, the group developed a plastic bolster that saves \$18 per vehicle and 8.3 pounds in body weight. The bolster is used in the Eagle Premier and Dodge Monaco.

## People

IN THE DODGE/WJR RADIO Quest for Excellence music competition, Beth Barley took first place and won a \$5,000 scholarship. She is the daughter of Lou Barley, a tool engineer from Chrysler's Mound Road Engine Plant in Detroit.

## Communication



IN RECOGNITION OF  
EXCELLENCE IN ACHIEVING



*"Your Personal Best"*

1985

Advance Product Planning Office  
to be the Best Goals

PAUL V. SHERIDAN

*L. A. Iacocca*

L. A. Iacocca

*E. A. Reickert*

E. A. Reickert

*Peter C. Badore*

P. C. Badore

*J. M. Hossack*

J. M. Hossack

*H. E. Cook*

H. E. Cook

*K. S. Mack*

K. S. Mack

# Tab J

**Personal Handwritten Note from Dean of the Cornell Law School  
Personal Handwritten Note from Dean of the Cornell Graduate School of Management**

**Subject: Paul V. Sheridan Receipt of Civil Justice Foundation National Champions Award  
For his work on transportation safety, the only person to win this award for such.**





## Cornell Law School

---

Stewart J. Schwab  
The Allan R. Tessler Dean  
and Professor of Law

June 22, 2005

Dear Paul,

I was delighted to see that you are to be honored as a Community Champion by the Civil Justice Foundation in Toronto next month. Congratulations!

We are always pleased when an alumnus of Cornell University gets the recognition they richly deserve.

I hope you enjoy the occasion, & I wish you success in your future endeavors.

Sincerely,  
Stef Schwab



OFFICE OF THE DEAN  
SAMUEL CURTIS JOHNSON GRADUATE SCHOOL OF MANAGEMENT  
CORNELL UNIVERSITY  
207 SAGE HALL  
ITHACA, NEW YORK 14853-6201

Dear Paul,

Thanks for stopping by during  
your recent visit to Ithaca and  
Cornell. Congratulations on being  
honored as a 2005 Community Champion  
by the Civil Justice Foundation. This  
is a wonderful personal and professional  
achievement.

Bob Swinga





  
Sheraton Centre



# Tab K

## 1986 Phase I Summary Report for Truck Dealership Visit Program\*

**Subject: Originally formatted and managed by Paul V. Sheridan for purpose of openly soliciting dealer principal and dealership management inputs to the Advanced Dodge Truck Product Programs, including solicitation of detailed competitive information and inputs on SUV vehicles**

**\* Abridged version**



1986 PHASE I  
SUMMARY REPORT

# TRUCK DEALER VISIT PROGRAM

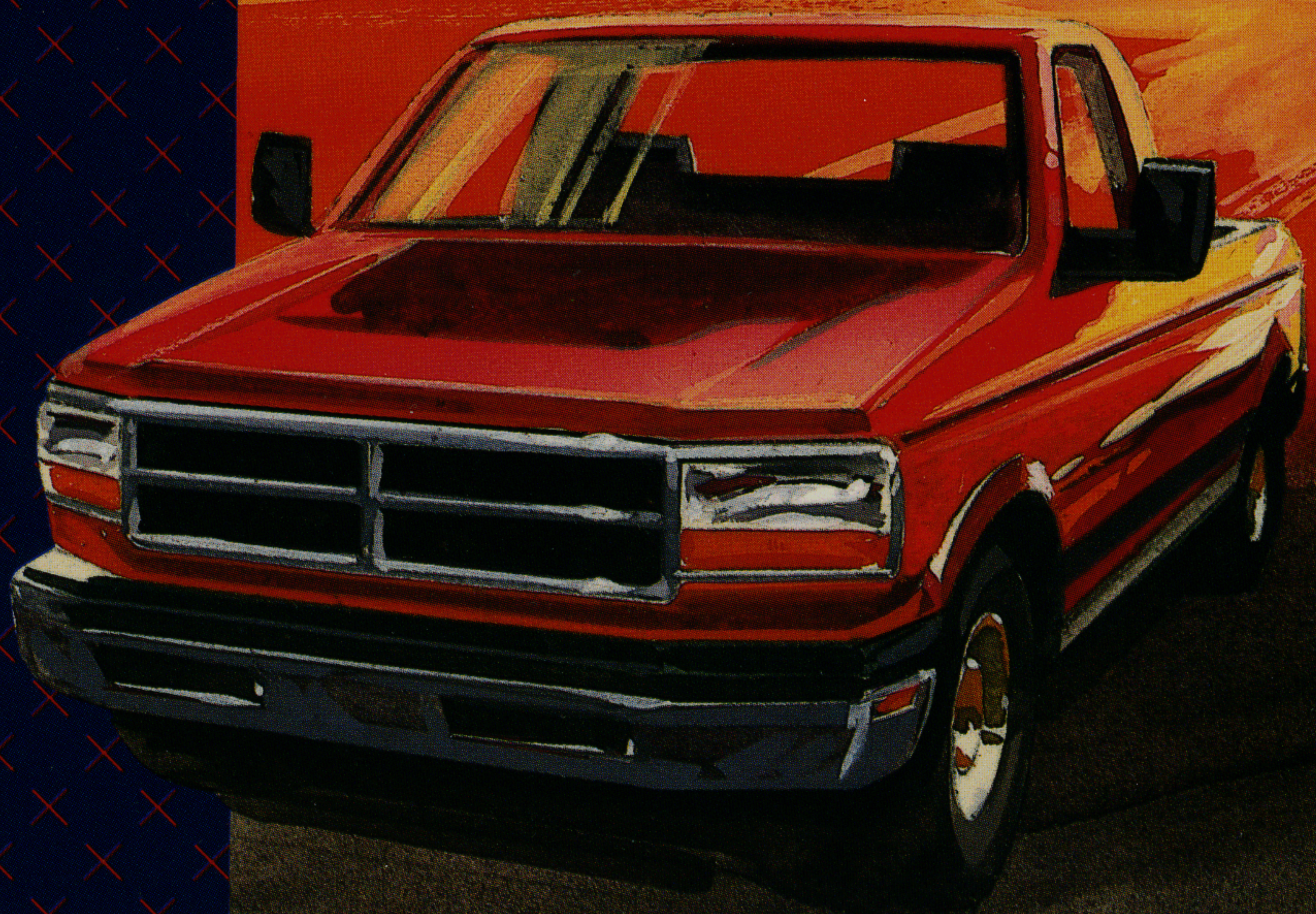

AMERICA'S BEST BACKED TRUCKS



**5/50  
RAM  
TOUGH**

**Dodge  
Truck**

DIVISION OF CHRYSLER MOTORS



# TRUCK DEALER VISITS - PHASE I SUMMARY REPORT

## TABLE OF CONTENTS

|  |        |
|--|--------|
| o INTRODUCTION                           | TAB 1  |
| o EXECUTIVE SUMMARY                      | TAB 2  |
| o DETAILED SUMMARY REPORT                | TAB 3  |
| o TRUCK DEALER VISIT ANNOUNCEMENT LETTER | TAB 4  |
| o GENERAL NOTES                          | TAB 5  |
| o "THOUGHT STARTERS" QUESTIONNAIRE       | TAB 6  |
| o ZONE VISIT SCHEDULE                    | TAB 7  |
| o TYPICAL ZONE VISIT CONFIRMATION LETTER | TAB 8  |
| o INDIVIDUAL ZONE VISIT REPORTS          |        |
| - SAN FRANCISCO                          | TAB 9  |
| - CHICAGO                                | TAB 10 |
| - ORLANDO                                | TAB 11 |
| - LOS ANGELES                            | TAB 12 |
| - CINCINNATI                             | TAB 13 |
| - NEW YORK                               | TAB 14 |
| - HOUSTON                                | TAB 15 |
| - DALLAS                                 | TAB 16 |
| - BOSTON                                 | TAB 17 |
| - SYRACUSE                               | TAB 18 |
| o PHASE II DESCRIPTION/SCHEDULE          | TAB 19 |
| o COMMENTS/ACKNOWLEDGEMENTS              | TAB 20 |

**TAB 1**

**INTRODUCTION**



# TRUCK DEALER VISITS - PHASE I SUMMARY REPORT

## INTRODUCTION

- Phase I of the truck dealer visit program was originally scheduled/formulated to provide market inputs to the advance product development process for full-size trucks via the May 5, 1986 Concept Approval Meeting (postponed).
- During the nine week period of February 23, 1986 through April 22, 1986, thirty-five truck dealers within ten Chrysler sales zones were visited. The ten zones, listed in order of visitation, included:
  - San Francisco
  - Chicago
  - Orlando
  - Los Angeles
  - Cincinnati
  - New York
  - Houston
  - Dallas
  - Boston
  - Syracuse
- Visitation was restricted to those dealers that have competitive domestic truck franchises as well as the Dodge franchise. The visits were attended by dealer principals/management, sales zone management and Chrysler Center personnel. The discussions were organized into the following categories:
  - Power Train
  - Pickup
  - Van/Wagon
  - General
- Chrysler Center participation included twenty middle management personnel, representing eight separate organizations. The represented organizations included:
  - Advance Planning
  - Advance Power Train Planning
  - Components Planning
  - Financial Planning
  - Manufacturing Feasibility
  - Program Management
  - Truck Operations
  - Vehicle Packaging
- The attached report attempts to fulfill multiple purposes:
  - First, an attempt is made via the "Executive Summary" (Tab 2) to review the general highlights of the program in a concise format. For those seeking additional discussion, a "Detailed Summary Report" is provided (Tab 3).
  - The second purpose is to provide the reader with a history/background of the truck dealer visit program while providing regional inputs for analysis of specific truck product strength/weaknesses. This portion of the report (Tabs 4 through 18) also provides a base for future dealer visit program formatting as well as possible format improvements/modifications as appropriate.
  - The third purpose is to announce/describe Phase II of the truck dealer visit program and provide a tentative Phase II dealer visit schedule (Tab 19).
- Finally, the attached report closes with general comments and acknowledgements to provide the more subjective aspects of the program as well as thank the participants for their support (Tab 20).



**TAB 4**

**TRUCK DEALER VISIT ANNOUNCEMENT LETTER**



# Inter Company Correspondence

F A X P A K

Telephone  
16

Date  
January 17, 1986

To — Name & Department

CIMS Number

All Zone Managers

From — Name & Department

CIMS Number

P. H. Kenningham Truck Sales Manager

USAS

Chrysler Center

414-05-26

Subject:

[REDACTED]

In the near future, there will be two teams from Detroit contacting some of our Truck dealers who also have a domestic competitive truck franchise (non-duals). The teams will be comprised of representatives from Advance Product Planning, Marketing, Program Management, Manufacturing, and Truck Operations. In all probability, the Truck Specialist will accompany the teams on the dealer contacts.

Please provide me with a list of your dealers (include city and state), that meet the above requirements, and that you would recommend as a beneficial contact. I would appreciate receiving your list by Wednesday, January 22, 1986.

If you have any questions, please call.

P. H. Kenningham

PHK/1-17/2

cc: D. L. Davis  
P. J. Keegan  
E. S. Clark  
T. C. McAlear  
All Regional Managers  
All Regional Truck Managers

**TAB 5**

**GENERAL NOTES**



TRUCK DEALER VISITS  
GENERAL NOTES

- o THE TRUCK DEALER VISIT PROGRAM IS BEING CONDUCTED SIMILAR TO THE C/P DEALER VISITS BUT INDEPENDENTLY.
- o THE OVERALL THEME OF THE VISITS IS TO DETERMINE/DISCUSS THE ISSUES RELEVANT TO THE FULL-SIZE PICKUP AND VAN/WAGON PRODUCT.
- o THE TENTATIVE SCHEDULING INVOLVES AT LEAST ONE ZONE VISIT PER WEEK.
- o PHASE I WILL INCLUDE TEN SALES ZONES AND BE COMPLETED BY APRIL 25, 1986. (PRE-MAY 5TH CONCEPT APPROVAL).
- o PHASE II WILL VISIT THE REMAINING ZONES AND IS PLANNED FOR COMPLETION BY YEAR-END.
- o TRIP PARTICIPANTS WILL INCLUDE REPRESENTATIVES FROM ADVANCE PLANNING, MARKETING, PROGRAM MANAGEMENT AND MANUFACTURING WHEN POSSIBLE. (THE BUSINESS GROUPS, LIBERTY AND OTHER RELEVANT ORGANIZATIONS WILL BE INCLUDED AS PART OF PHASE II).
- o EACH TRIP WILL INCLUDE A REPRESENTATIVE OF ADVANCE PLANNING WHEN FEASIBLE.
- o FROM THREE TO FOUR DEALER VISITS IS USUALLY REQUIRED TO ACCURATELY SURVEY A PARTICULAR GEOGRAPHIC AREA. THE DEALERS ARE SELECTED BY ZONE MANAGEMENT ON THE BASIS OF TRUCK SALES PERFORMANCE, ETC.
- o THE TRUCK DEALERS VISITED WILL INCLUDE "DUAL" FRANCHISES (DODGE/FORD, DODGE/CHEVY OR DODGE/GMC) AND OWNERS OF MULTIPLE TRUCK FRANCHISES. IT IS IMPORTANT THAT BOTH THE DODGE AND COMPETITIVE DEALER TRUCK MANAGERS BE PRESENT.
- o WHEN AN INTERESTING OR IMPORTANT COMMENT IS MADE BY A DEALER, TIME SHOULD BE SPENT GETTING THE DETAILS OF WHY THEY HAVE THIS OPINION, ETC.
- o IN GENERAL IT IS RECOMMENDED THAT VISIT PARTICIPANTS CONSOLIDATE THE DEALER VISIT MINUTES/NOTES THE EVENING IMMEDIATELY FOLLOWING THE VISIT.
- o DEALER VISIT PARTICIPANTS ARE ADVISED TO BRING AN AMPLE SUPPLY OF BUSINESS CARDS.

PAUL V. SHERIDAN OF ADVANCE PLANNING IS COORDINATING THE TRUCK DEALER VISITS AND CAN BE CONTACTED ON EXTENSION 6-0341, CIMS NUMBER 415-03-10. IF NOT AVAILABLE, CONTACT LARRY A. TURNER, EXT. 6-6068.



**TAB 7**

**ZONE VISIT SCHEDULE**

TRUCK DEALER VISITS - PHASE I SUMMARY REPORTZONE VISIT SCHEDULE

| <u>ZONE</u>   | <u>NUMBER OF DEALERS</u> | <u>VISIT DATE*</u> | <u>PARTICIPANTS</u>  | <u>ORGANIZATION</u>   |
|---------------|--------------------------|--------------------|--|---|
| San Francisco | 4                        | 02/23/86           | T. DeBoer<br>W. D. McAuley<br>D. H. Olsen  | Truck Operations<br>Manufacturing Feasibility<br>Financial Planning   |
| Chicago       | 4                        | 03/02/86           | E. J. Perkins<br>R. E. Pfeifer<br>T. A. Skemp  | Manufacturing Feasibility<br>Program Management<br>Advance Power Train Planning   |
| Orlando       | 3                        | 03/09/86           | T. B. Gage<br>R. R. Reeder<br>P. V. Sheridan   | Advance Power Train Planning<br>Body Components Planning<br>Advance Planning  |
| Los Angeles   | 3                        | 03/16/86           | R. E. Pfeifer<br>L. A. Turner  | Program Management<br>Advance Planning  |
| Cincinnati    | 4                        | 03/16/86           | T. DeBoer<br>E. J. Perkins<br>T. A. Skemp  | Truck Operations<br>Manufacturing Feasibility<br>Advance Power Train Planning   |
| New York      | 4                        | 03/30/86           | A. C. LaCroix<br>J. E. Reece   | Vehicle Packaging<br>Advance Planning   |
| Houston**     | 4                        | 04/06/86           | R. E. Burnham<br>R. O. Eccles<br>J. M. Hossack<br>D. H. Olsen<br>K. J. Price<br>L. A. Turner | Advance Planning<br>Advance Planning<br>Components Planning<br>Financial Planning<br>Truck Operations<br>Advance Planning |
| Dallas        | 2                        | 04/06/86           | J. M. Hossack<br>K. J. Price<br>L. A. Turner   | Components Planning<br>Truck Operations<br>Advance Planning   |
| Boston        | 4                        | 04/13/86           | R. E. Burnham<br>J. R. Thomson<br>H. C. VonRusten  | Advance Planning<br>Product Systems Planning<br>Program Management  |
| Syracuse      | 3                        | 04/20/86           | P. V. Sheridan<br>T. A. Simonsen<br>F. B. Whelan   | Advance Planning<br>Truck Operations<br>Power Train Components Planning   |

\* Week beginning.

\*\* Included coordination/participation in Houston Truck & Features Research.

**TAB 8**

**TYPICAL ZONE VISIT CONFIRMATION LETTER**





March 25, 1986

Mr. Eric R. Kaplan  
Truck Manager  
Houston Sales Zone Office  
CHRYSLER CORPORATION  
P. O. Box 60507  
Houston, TX 77205-0507

Dear Mr. Kaplan:

**SUBJECT: TRUCK DEALER VISITS**

As promised, I am enclosing the itinerary for the upcoming visit by Chrysler Center personnel to the selected truck dealers in the Houston zone.

The general purpose of these meetings is to discuss the present and future requirements of the full-size pick-up and van/wagon markets. In general it is highly recommended that both the Dodge truck manager as well as the competitive truck manager be present during these meetings. Specific discussion items should include buyer wants/needs, Dodge truck product strengths/weaknesses, advertising copy, etc. Additional items, such as power train issues, minivans, etc. are also a welcome part of what will prove to be productive and informative discussions.

Again, the field visit teams are comprised of representatives from three or four functional groups that have direct impact on the Dodge truck product. I can assure you that these individuals have been selected to participate as a result of their admirable ability to relate to and effect the comments/suggestions from our all-important truck dealer body. They sincerely look forward to meeting with the selected dealers in your zone.

If there are any questions with respect to the subject, please do not hesitate to contact me on (313) 956-0341 or 8-876-0341 or Larry Turner on 8-876-6068.

Sincerely,

Paul V. Sheridan  
Advance Vehicle Planning

Enclosure  
400 PVS.5C

cc: Mr. Jack Apple, Jr., Greenspoint Dodge  
Mr. Ramsay Gillman, Gillman Dodge  
Mr. Dom Torres, Mac Haik Dodge  
Mr. Mike Hall, Mike Hall Dodge  
Mr. T. R. Marinelli, Zone Manager



TRUCK DEALER VISITS - PHASE I

TRIP ITINERARY

TEAM #7 - HOUSTON/DALLAS ZONES

|                | <u>ORGANIZATION</u> | <u>LOCATION</u> | <u>DEPT.</u> | <u>CONTROL #</u> |
|----------------|---------------------|-----------------|--------------|------------------|
| R. E. Burnham* | Advance Plng.       | 1225            | 4810         | T-81238          |
| R. O. Eccles*  | Advance Plng.       | 1225            | 4810         | T-81239          |
| J. M. Hossack  | Components Plng.    | 1225            | 4820         | T-75569          |
| K. J. Price    | Truck Marketing     | 2700            | 2511         | T-05352          |
| L. A. Turner   | Advance Plng.       | 1225            | 4810         | T-75571          |

\* HOUSTON ONLY

APRIL 3, 1986 (THURSDAY) - R. E. Burnham

- Continental Flight #393 (International Airport) Departs Detroit 8:15 a.m. Arrives Houston 10:00 a.m.
- Shuttle service to Westin Galleria provided every 20 minutes via the Post Oak Terminal. A block of rooms is reserved for Chrysler personnel.

APRIL 4, 1986 (FRIDAY) - R. O. Eccles/K. J. Price/L. A. Turner

- Republic Flight #289 (Hobby Airport) Departs Detroit 1:10 p.m. Arrives Houston 3:05 p.m.

APRIL 4, 1986 (FRIDAY) - J. M. Hossack

- American Flight #317/271 (Hobby Airport) - Avis Rental Departs Detroit 7:05 p.m. Arrives Houston 10:47 p.m.
- Take shuttle service to Westin (See April 3)

APRIL 7, 1986 (MONDAY) - R. E. Burnham/R. O. Eccles/J. M. Hossack/K. J. Price/L. A. Turner

- 7:30 a.m. Meet Eric Kaplan/Ed Eskola (Houston Zone, 713/820-6823) for breakfast in Westin lobby.
- 9:00 a.m. Gillman Dodge (REB/ROE with Eric Kaplan)  
Mike Hall Dodge (JMH/KJP/LAT with Ed Eskola)
- 1:30 p.m. Mac Haik Dodge (REB/ROE with Eric Kaplan)  
Greenspoint Dodge (JMH/KJP/LAT with Ed Eskola)
- Continental Flight #392 (REB/ROE) Departs Houston 7:10 p.m. Arrives Detroit 10:40 p.m.

- 
- Continental Flight #163 (JMH/KJP/LAT) Departs Houston 7:55 p.m. Arrives Dallas 8:50 p.m.

- Take shuttle service to Marriott DFW, three separate rooms reserved (JMH/KJP/LAT).

APRIL 8, 1986 (TUESDAY) - J.M. Hossack/K. J. Price/L. A. Turner

- 7:30 a.m. Meet Fred Salinas/Michael Hale (Dallas Zone, 214/242-8449) for breakfast in TBD lobby.
- 9:30 a.m. Preston II Chrysler-Dodge
- 2:30 p.m. Irby Chrysler-Dodge
- American Flight #158 Departs Dallas 8:00 p.m. Arrives Detroit 11:15 p.m.



TRUCK DEALER VISITS - PHASE I

HOUSTON AND DALLAS ZONES

DEALER

VISIT TIME/DATE

Mr. Ramsay Gillman  
GILLMAN DODGE  
7157 Fongren Road  
Houston, TX 77036

Monday; April 7, 1986  
9:00 a.m.

Mr. Mike Hall  
MIKE HALL DODGE  
10650 Eastex Freeway  
Houston, TX 77093  
713/695-2455

Monday; April 7, 1986  
9:00 a.m.

Mr. Dom Torres  
MAC HAIK DODGE  
11890 Old Katy Road  
Houston, TX 77079  
713/870-9999

Monday; April 7, 1986  
1:30 p.m.

Mr. Jack Apple, Jr.  
GREENSPPOINT DODGE  
11655 North Freeway  
Houston, TX 77060  
713/820-3355

Monday; April 7, 1986  
1:30 p.m.

-----  
Mr. Monte White  
PRESTON II CHRYSLER-DODGE  
1295 North Central Expressway  
Richardson, TX 75080  
214/234-3444

Tuesday; April 8, 1986  
9:30 a.m.

Mr. George Irby  
IRBY CHRYSLER-DODGE  
4201 West Camp Wisdom Road  
Dallas, TX 75237  
214/296-0026

Tuesday; April 8, 1986  
2:30 p.m.



**PHASE TWO DESCRIPTION / SCHEDULE**

# TRUCK DEALER VISITS - PHASE I SUMMARY REPORT

## PHASE II DESCRIPTION/SCHEDULE

### Phase II Description

- Phase II was originally demarcated as the post-May 5, 1986 Concept Approval Meeting portion of the dealer visits. The purpose is a continuation of the Phase I inputs but to checkpoints later in the advance product development process for the full-size truck program.
- During the Phase I visits it was officially announced that two additional zone offices would be formed bringing the total Chrysler sales zones to twenty-five. This leaves fifteen remaining for Phase II visitation. (Advance notice of the additional sales office formations was used to select the Phase I zones, avoiding the "shake-up" environments of the affected zones).
- Phase II will also expand organizational participation to include the Business Groups and Project Liberty. An "Information Meeting" will be scheduled for early June to acquaint the new participants with the program. For the most part, Phase II will have a format similar to that described on the "General Notes" page (Tab 5).

### Schedule

- Shown below is the tentative Phase II visit schedule:

| <u>Sales Zone</u> | <u>Week Beginning (1986)</u> |
|-------------------|------------------------------|
| Washington, D.C.  | 6-15                         |
| St. Louis         | 6-22                         |
| Phoenix           | 6-29                         |
| <br>              |                              |
| New Orleans       | 7-13                         |
| Atlanta           | 7-20                         |
| Denver            | 7-27                         |
| <br>              |                              |
| Memphis           | 8-10                         |
| Kansas City       | 8-17                         |
| Philadelphia      | 8-24                         |
| <br>              |                              |
| Pittsburgh        | 9-7                          |
| Portland          | 9-14                         |
| Detroit           | 9-21                         |
| <br>              |                              |
| Minneapolis       | 10-5                         |
| Charlotte *       | 10-12                        |
| Milwaukee *       | 10-19                        |

\* New

**TAB 20**

**COMMENTS / ACKNOWLEDGEMENTS**



# TRUCK DEALER VISITS - PHASE I SUMMARY REPORT

## COMMENTS/ACKNOWLEDGEMENTS

### COMMENTS

- Complete unanimity exist among the dealers, zone management, and the dealer visit teams with respect to the value of Corporate visitation to the truck dealers. Many dealers made special personal arrangements or demands on their subordinates to ensure participation. Likewise, the support and enthusiasm of the ten zones was second only to the precision of their coordination/accomodation efforts.
- A subtle but important outcome also includes the "education process" that nearly all visit team members underwent during Phase I of the program. The necessity to "Think Trucks" on the part of more Corporate personnel as the first step in the process of enhancing the Dodge truck products was greatly facilitated.
- The fact that our Japanese competitors are constantly visiting their dealers - "and doing so all the way from Tokyo!" - became a tiresome reprimand for many of the visit teams. If nothing else, Phase I verified that the affirmative would be appropriate with respect to the dealer inquiry, "Are you guys going to be visiting with us regularly?"

### Acknowledgements

- Advance Planning would like to thank the Chrysler Center personnel who participated and did an admirable job of reporting the discussion content of the Phase I truck dealer visits.
- The management of the ten Phase I zones are also deserving of applause. The zones performed flawlessly in their support and accompaniment of the dealer visits.
- We would like to thank the thirty-five dealers for participating and hereby ensure them that their comments will continue to be sought and are already being "dovetailed" into the planning of both present and future truck products.
- A special thanks goes to Pentastar Travel whose agents assisted with the utmost courtesy and competence; providing a "no-hitches" scenario time and time again, regardless of the frequent changes to the trip itineraries.
- Finally, Advance Planning would like to sincerely thank the many secretaries for their support and for their patience while typing all of this!

# Tab L

## Criminal Gross Negligence

## **Criminal Gross Negligence**

“Gross negligence” is culpable or criminal when accompanied by acts of commission or omission of a wanton or willful nature, showing a reckless or indifferent disregard of the rights of others, under circumstances reasonably calculated to produce injury, or which make it not improbable that injury will be occasioned, and the offender knows or is charged with knowledge of the probable result of his acts; “culpable” meaning deserving of blame or censure.

Bell v. Commonwealth, 170 Va. 597, 195 S.E. 675, 681.



# End of Document

To: Mr. David Kelleher, Chairman  
National Automobile Dealers Association  
c/o David Dodge Chrysler Jeep  
1801 Route 202  
Glen Mills, PA 19342  
610-358-5300 ext.1000  
dkelleher@drivedavid.com

Date: 11 April 2012

VIA FEDEX AIRBILL #8694 – 4998 - 3946

From: Mr. Paul V. Sheridan  
DDM Consultants  
22357 Columbia Street  
Dearborn, MI 48124-3431  
313-277-5095  
[pvs6@Cornell.edu](mailto:pvs6@Cornell.edu)

**Subject: Automotive Product Defect Liability: Dealership Responsibility for Punitive Damages**

**Reference 1: Jeep Grand Cherokee Fuel System Defect Investigation (NHTSA PE10 – 031)**

**Reference 2: Voluntary Recall of Jeep Liberty Recall for Rust – 7 March 2012**