



May 6, 2015

Dear Customer:

The following is the proof-of-delivery for tracking number **128318100004657**.

Delivery Information:

Status:	Delivered	Delivery location:	1300 I ST Sacramento, CA 95814
Signed for by:	VHOUSTON	Delivery date:	May 5, 2015 10:19
Service type:	FedEx Ground		
Special Handling:			

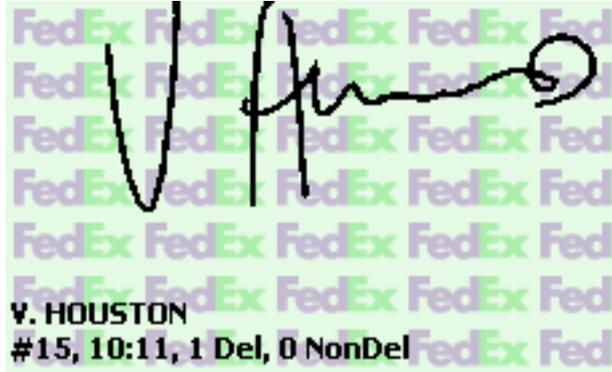

Shipping Information:

Tracking number:	128318100004657	Ship date:	Apr 29, 2015
		Weight:	3.9 lbs/1.8 kg

Recipient:
Attorney General Kamala D. Harris
Office of the Attorney General 1300
"I" Street
Sacramento, CA 95814-2919
916-445-9555

Shipper:
SHERIDAN, PAUL V
22357 COLUMBIA ST
DEARBORN, MI 481243431 US

Thank you for choosing FedEx.

DDM Consulting
22357 Columbia Street
Dearborn, MI 48124-3431
313-277-5095
pvs6@Cornell.edu

29 April 2015

Attorney General Kamala D. Harris
Office of the Attorney General
1300 "I" Street
Sacramento, CA 95814-2919
916-445-9555

Subject: Criminal Investigation of those Responsible for the Severe Injury to the Sanchez Brothers

Reference: Conspiratorial Closure of NHTSA EA12-005: Jeep Fuel System Crashworthiness Defect

Dear Madam Attorney General Harris:

Attachment 1 is the jury verdict form from the fire-death trial of a 4-year-old boy, Remington Walden. Signed on April 2, 2015, the jury had unanimously assigned the following "percentage of fault for each defendant" :

Driver of the vehicle that collided with the Jeep wherein Remington was a rear-seat passenger: **1%**
Fiat-Chrysler Automotive (FCA), the group that designed/profited from sale of defective Jeeps: **99%**

Attachment 2 is a press release relating to the Walden verdict; please note it discusses the "Baker memo."

Attachment 3 was sent to Center for Auto Safety (CAS) Director Clarence Ditlow on February 12, 2015. Note that Attachment 3 called for a criminal investigation regarding these matters three months prior to the "percentage of fault for each defendant" jury determination in Walden v FCA.

Attachment 4 was sent to CAS on August 20, 2014. Note that I had called for a criminal investigation of these matters eight months prior to the "percentage of fault" jury determination in Walden. Please note that the first page lists the Chavez Law Group, the California law firm representing the Sanchez brothers, Magdaleno and Raymundo. Please note Page 1 depicts the Sanchez Jeep burning on the 110 Freeway in Los Angeles on the evening of April 3, 2014.

Michigan Attorney General Bill Schuette received Attachment 5 on April 24, 2015. The severe injury to the Sanchez Brothers is detailed on Page 3. **My suggestion is, as a primer for the Subject, please review Attachment 5 (and its many hyperlinked references), especially Pages 13 and 14.**

Paraphrasing Attachment 5 page 29: I am confident that when a grand jury is convened in California for the purposes of a criminal investigation of the severe injury to the Sanchez Brothers, the members will assess that FCA and NHTSA/DOT acted in a manner that made it:

" . . . not improbable that injury will be occasioned, and the offender knows, or is charged with the knowledge of, the probable result of his acts."

Please do not hesitate to contact me at any time,

Respectfully,

Paul V. Sheridan

Attachments

Inter Company Correspondence

	File Code	Date	
		August 24, 1978	
<u>Name & Department</u>	<u>Division</u>	<u>Plant/Office</u>	<u>CIMS Number</u>
R. M. Sinclair, Director International Product Development	Product Plan. & Design Office	Chrysler Center	416-20-15
<u>Name & Department</u>	<u>Division</u>	<u>Plant/Office</u>	<u>CIMS Number</u>
L. L. Baker, Manager Automotive Safety	Engineering Office	Chrysler Center	418-12-34

Subject: Fuel System Design - Chrysler Passenger Cars And Trucks.

Pursuant to the discussions between Messrs. Vining, Jeffe, Sperlich and yourself with Mr. Mochida on August 22, the fuel system design for domestic passenger cars and trucks is summarized for Mr. Mochida's information.

Not only are the impact performance requirements of MVSS-301 pertinent to the design approach but the significant increase in the last few years in the numbers of product liability cases involving fuel system fires and the increase in the size of the awards by sympathetic juries has to be recognized. In the Ford Pinto case the NHTSA Office of Defects Investigation selected arbitrary performance criteria of minimal or no fuel leakage when the test car is impacted in the rear by a full size car at 35 mph as a basis for questioning the safety of a recall modification of the Pinto.

. Passenger Car

Fuel Tank Location

The front wheel drive configuration in Chrysler's Omni and Horizon allowed the fuel tank to be located beneath the rear seat. This location provides the protection of all of the structure behind the rear wheels—as well as the rear wheels themselves—to protect the tank from being damaged in a collision. This same location will be used in the new 1981 K-Body cars which will also have a front wheel drive.

The rear wheel drive H-Body scheduled for introduction in 1983 will have the fuel tank located over the rear axle and beneath the floor pan.

The question of whether M, R or J-Body cars should be converted to tank over axle prior to their phase-out is a matter under intensive study at this time.

Filler Neck And Cap

As the fuel tank is moved to a more forward location, the fuel fill is moved to the side of the car. The fuel cap will be recessed below the body surface and a fuel fill door provided. The fuel filler neck is designed to break away from the car body with the fuel filler cap still in place.

In this design the filler cap and fill neck or fill tube remain with the tank to avoid separation and possible fuel leakage. This side fill is scheduled for J and M-Bodies in 1980 and the Y-car in 1981.

The fuel fill is less likely to be damaged in a sideswipe when located on the right side of the car. As new models are introduced, the fuel fill will be moved to the right side of the vehicle. This may also offer greater protection to drivers who run out of gasoline on the highway, since they will fill the tank on the side away from the traffic.

Structure

In 1979 through 1983, the M, R, and J model cars which have the fuel tank under the floor pan behind the rear wheels, structural reinforcement of the longitudinals on each side of the tank, shielding of any unfriendly surfaces adjacent to the tank, and the design of straps and hangers to limit undesired tank movement will be employed.

Truck

Fuel Tank Location

The same principles regarding fuel tank location apply to truck design. It is important that these larger fuel tanks are not only shielded from damage in a collision but do not break away from the truck and thereby spread fuel onto the roadway. The approach used by Mitsubishi on the SP-27 of locating the fuel tank ahead of the rear wheels appears to provide good protection for the tank.

The front wheel drive 'T-115 to be introduced in 1982 will have the fuel tank ahead of the rear wheels and under the rear seat. However, in rear wheel drive trucks there is no clearance over the axle for fuel tank installation and in many cases there is insufficient space ahead of the axle for fuel tanks of the desired capacity.

Chrysler is investigating fuel tank relocation ahead of the rear wheels for vans and multi-purpose vehicles, but present plans for pickups through 1983 and for MPV's and vans through 1985 have the fuel tank located behind the rear wheels. In vehicles both with and without bumpers there is a concern with vertical height differences that create a mismatch with passenger car bumpers. Where fuel tank location behind the rear axle is all that is feasible, a protective impact deflection structure may have to be provided whether or not a bumper is provided. An investigation whether to relocate the fuel tank or to provide impact deflecting structures is presently underway.

Fill Neck And Cap

All trucks and vans have side fill. The sweptline pickup truck (DW 1-3) and multi-purpose vehicles (AD-1 & AW-1) will have a recessed fill cap and fuel filler door beginning in 1981.

L. L. Baker

ATTACHMENT 1

29 April 2015

Attorney General Kamala D. Harris
Office of the Attorney General
1300 "I" Street
Sacramento, CA 95814-2919
916-445-9555

Subject: Criminal Investigation of those Responsible for Severe Injury to the Sanchez Brothers
Reference: Conspiratorial Closure of NHTSA EA12-005: Jeep Fuel System Crashworthiness Defect

Two Pages

Jury verdict form, fire-death trial of a 4-year-old Georgia boy, Remington Walden. Issued on April 2, 2015, the jury unanimously assigned the following “percentage of fault for each defendant” :

Driver of the vehicle that collided with the Jeep wherein Remington was a rear-seat passenger: 1%

Fiat-Chrysler Automotive (FCA), the group that designed/profited from sale of defective Jeeps: 99%

IN THE SUPERIOR COURT OF DECATUR COUNTY
STATE OF GEORGIA

Filed In Open Court
Date: 9-2-15
Time: 6:30 pm
Decatur County, Georgia

JAMES BRYAN WALDEN and LINDSAY
NEWSOME STRICKLAND, Individually and
on Behalf of the Estate of Their Deceased Son,
REMINGTON COLE WALDEN,
Plaintiffs,

*
*
* CIVIL ACTION
* FILE NO. 12CV472
*
*
*
*
*
*
*
*

vs.

CHRYSLER GROUP LLC, n/k/a FCA US
LLC and BRYAN L. HARRELL,
Defendants.

SPECIAL INTERROGATORIES AND VERDICT

In the matter above-styled, we the jury find as follows:

Answer the following questions:

1. Do you find that Chrysler Group acted with a reckless or wanton disregard for human life in the design or sale of the 1999 Jeep Grand Cherokee and that such conduct was a proximate cause of damages for which the Plaintiffs may recover?

yes (yes or no)

2. Do you find that Chrysler Group had a duty to warn and failed to warn of a hazard associated with the use of the 1999 Jeep Grand Cherokee and that such failure to warn was a proximate cause of damages for which the Plaintiffs may recover?

yes (yes or no)

3. Do you find that Defendant Bryan Harrell's negligence, which he has admitted, proximately caused damages for which the Plaintiffs may recover?

yes (yes or no)

4. State the amount of damages, if any, you find Plaintiffs are entitled to recover from the Defendant or Defendants you have found responsible for:

Pain and suffering:

\$ ~~60 million~~ 30 million

Full value of the life of Remington Walden:

\$ ~~20 million~~ 120 million

5. State the percentage of fault of each Defendant (total must equal 100%):

1 % Bryan Harrell and

99 % Chrysler Group

SO SAY WE ALL.

This 2nd day of April, 2015.

Deborah McIntyre
Foreperson

ATTACHMENT 2

29 April 2015

Attorney General Kamala D. Harris
Office of the Attorney General
1300 "I" Street
Sacramento, CA 95814-2919
916-445-9555

Subject: Criminal Investigation of those Responsible for Severe Injury to the Sanchez Brothers

Reference: Conspiratorial Closure of NHTSA EA12-005: Jeep Fuel System Crashworthiness Defect

Two Pages

Paul V. Sheridan press release relating to the \$150,000,000.00 jury verdict in Walden v FCA. Discusses the public release of the instant attachment to cover letter, the Baker memo.

Press Release of Paul V. Sheridan Response to Walden v FCA Jury Verdict of \$150,000,000.00

On May 19, 2010 my presence at a Senate Committee on Commerce, Science, and Transportation was requested by Center for Auto Safety (CAS) Director, Clarence Ditlow. This hearing reviewed the plight inflicted upon automotive safety whistleblowers. Senator Jay Rockefeller was deeply chagrined when Mr. Ditlow informed him that my plight included being sued as an individual by Chrysler for the largest amount in history: \$82,000,000.00.

During the above I was introduced to National Highway Traffic Safety Administration (NHTSA) Administrator Mr. David Strickland. The introduction was made by Mr. Ditlow, and former NHTSA Administrator Joan Claybrook.

During this face-to-face discussion with Mr. Strickland I reviewed my participation in the CAS Petition of October 2, 2009; the latter requested a formal NHTSA investigation of the fuel system safety defect in Jeep sport utility vehicles. With Ditlow and Claybrook as witnesses, I informed Mr. Strickland of my possession of a key internal Chrysler document which described in-detail what the engineers and product managers at Chrysler have known since not later than 1978: *Placing a fuel tank behind the rear axle, below the bumper, and leaving it completely unprotected from direct collision impact, constituted a "fundamental safety defect."*

I informed Mr. Strickland of the legally "protected" status of this two-page document, a status that had been demanded by Chrysler defense lawyers as part of their secret lawsuit settlements. I suggested to Mr. Strickland that an official NHTSA request for the document would obviate the legal risks of disclosure. At this point Mr. Strickland formally requested that I forward to him, what has come to be called, the "Baker Memo." From that moment forward, the memo became a public document. It was received by NHTSA on June 1, 2010. The Baker memo was later added to the public file of the NHTSA Defect Petition 09-005.

The Baker memo, dated August 24, 1978, distributed throughout Chrysler and its suppliers, details approaches to ensure the crashworthiness of fuel system design. Mr. Baker, then a high-level Safety Manager in Chrysler Engineering:

"Chrysler is investigating fuel tank relocation ahead of the rear wheels for vans and multipurpose vehicles, but present plans for pickups through 1983 and for MPV's and vans through 1985 have the fuel tank located behind the rear wheels. In vehicles both with and without bumpers there is a concern with vertical height differences that create a mismatch with passenger car bumpers. Where fuel tank location behind the rear axle is all that is feasible, a protective impact deflection structure may have to be provided whether or not a bumper is provided. An investigation whether to relocate the fuel tank or to provide impact deflecting structures is presently underway."

Mr. Baker discussed the need to relocate the fuel tank "ahead of the rear wheels." Note also that he emphasizes the need for "impact deflecting structures." Nowhere in this memo, which was received by Mr. Strickland in June 2010, does Mr. Baker suggest that a trailer hitch in any way contributed to the crashworthiness of the Jeep SUV. In fact, the term 'trailer hitch' is nowhere to be found.

Three years after his receipt of the Baker memo, Administrator Strickland convened a secret, closed-door meeting on June 9, 2013 with Secretary of Transportation Raymond LaHood, and Fiat-Chrysler Automobiles (FCA) Chairman Sergio Marchionne. At the trial of Walden versus FCA, emails were disclosed that demonstrate the level of accommodation that Strickland and LaHood offered, not to the taxpayer, but to their suitors at FCA. That accommodation resulted in the joint June 10, 2013 announcement that a "trailer hitch" was the remedy for crashworthiness, and only for a restricted number of Jeeps that FCA agreed to recall.



On the basis of these and other facts presented at trial, none of which could be rebutted by FCA defense lawyers, the jury ordered that the Walden family be compensated for the fire-death loss of 4-year-old Remington with a unanimous verdict of \$150,000,000.00.



One of the key documents that convinced the Walden jury that their verdict was appropriate was the 1978 Baker memo. However, rather than bringing this type of documentary evidence to the secret meeting in Chicago, none of which would present the term 'trailer hitch,' Mr. Strickland essentially brought an updated copy of his personal resume. Later in 2013, Mr. Strickland acquired a high level position at a Washington, D.C. law and lobbying firm that is retained by FCA. Mr. Strickland not only betrayed my trust, he betrayed the trust of the American taxpayer and the Obama Administration.

“ . . . rather than bringing this type of documentary evidence to the secret meeting in Chicago, none of which would present the term ‘trailer hitch,’ Mr. Strickland essentially brought an updated copy of his personal resume.”

A year after Mr. Strickland assumed his “new job at Chrysler,” a 23-year-old expecting mother burned to death in a Jeep Liberty. The horrific fire death of Kayla White occurred in Michigan on November 11, 2014. The accident occurred less than a 15-minute drive from FCA headquarters in Auburn Hills, Michigan. Her manslaughter was a direct result of the secret meeting in Chicago on June 9, 2013 between LaHood, Marchionne and Strickland.



On the basis of the manslaughter of Kayla White, the unanimous verdict of \$150,000,000.00 in the trial of Walden versus FCA, the emails that were disclosed at trial, and the further evidence that such a proceeding would produce, I hereby renew my request that a criminal investigation of Mr. Raymond LaHood, Mr. Sergio Marchionne, and Mr. David Strickland be initiated by not only the Department of Justice, but by the relevant state attorneys general, including but not limited to Michigan Attorney General Bill Schuette.

The formal details of my original request for a criminal investigation are here:

<http://pvsheridan.com/Sheridan2Ditlow-4-12Feb2015.pdf>

ATTACHMENT 3

29 April 2015

Attorney General Kamala D. Harris
Office of the Attorney General
1300 "I" Street
Sacramento, CA 95814-2919
916-445-9555

Subject: Criminal Investigation of those Responsible for Severe Injury to the Sanchez Brothers
Ref: Conspiratorial Closure of NHTSA EA12-005: Jeep Fuel System Crashworthiness Defect

Fifty-Three Pages

Letter sent to the Center for Auto Safety Director Clarence Ditlow on February 12, 2015. Called for criminal investigation regarding these matters three months prior to the “percentage of fault for each defendant” determination in \$150,000,000.00 jury verdict in Walden v FCA:

Driver of the vehicle that collided with the Jeep wherein Remington was a rear-seat passenger: 1%
Fiat-Chrysler Automotive (FCA), the group that designed/profited from sale of defective Jeeps: 99%



February 13, 2015

Dear Customer:

The following is the proof-of-delivery for tracking number **780205284116**.

Delivery Information:

Status:	Delivered	Delivery location:	1825 CONN AVE NW 330 Washington, DC 20009
Signed for by:	Signature release on file	Delivery date:	Feb 13, 2015 13:40
Service type:	FedEx Priority Overnight		
Special Handling:	Deliver Weekday		

NO SIGNATURE REQUIRED

Proof-of-delivery details appear below; however, no signature is available for this FedEx Express shipment because a signature was not required.

Shipping Information:

Tracking number:	780205284116	Ship date:	Feb 12, 2015
		Weight:	1.0 lbs/0.5 kg

Recipient:**Clarence Ditlow****Center for Auto Safety**

1825 Connecticut

Suite 330

Washington, DC 20009 US

Shipper:**Paul Sheridan**

Sheridan Paul

22357 COLUMBIA ST

DEARBORN, MI 48124 US

Thank you for choosing FedEx.

To: Mr. Clarence M. Ditlow, Director
Center for Auto Safety - Suite 330
1825 Connecticut Ave, NW
Washington, DC 20009-5708
202-328-7700

Date: 12 February 2015

VIA FEDEX AIRBILL 8007 – 9341 - 5929

From: Paul V. Sheridan
DDM Consulting
22357 Columbia Street
Dearborn, MI 48124-3431
313-277-5095 / pvs6@cornell.edu

Subject 1: Criminal Investigation of DOT, NHTSA and FCA (Re: Closure of EA12-005)
Subject 2: The Manslaughter of Ms. Kayla Lucille White on 11 November 2014

Reference 1: My Letter to Center for Auto Safety (CAS) of 20 August 2014

Reference 2: My Letter to Calvin L. Scovell, III (Inspector General of the DOT) of 11 September 2014

Courtesy Copy List

Honorable Eric H. Holder, Jr
U.S. Attorney General
U.S. Department of Justice
950 Pennsylvania Avenue, NW
Washington, DC 20530-0001
202-514-2000

Ms. Loretta E. Lynch
United States Attorney's Office
Eastern District of New York
271 Cadman Plaza East
Brooklyn NY 11201
718-254-7000

Mr. Courtney E. Morgan, Jr.
Morgan & Meyers, PLLC
Suite 320
3200 Greenfield Road
Dearborn, MI 48120
313-961-0130

Secretary Anthony R. Foxx
US Department of Transportation
1200 New Jersey Ave, SE
Washington, DC 20590
202-366-4000

Mr. David J. Friedman
NHTSA Headquarters
West Building
1200 New Jersey Avenue, SE
Washington, DC 20590

* This document, with active hyperlinks is available at :

<http://pvsheridan.com/Sheridan2Ditlow-4-12Feb2015.pdf>

DDM Consulting
22357 Columbia Street
Dearborn, MI 48124-3431
313-277-5095 / pvs6@cornell.edu

12 February 2015

VIA FEDEX AIRBILL 8007 – 9341 - 5929

Mr. Clarence M. Ditlow, Director
Center for Auto Safety - Suite 330
1825 Connecticut Ave, NW
Washington, DC 20009-5708

Subject 1: Criminal Investigation of DOT, NHTSA and FCA (Re: Closure of EA12-005)
Subject 2: The Manslaughter of Ms. Kayla Lucille White on 11 November 2014

Reference 1: My Letter to Center for Auto Safety (CAS) of 20 August 2014

Reference 2: My Letter to Calvin L. Scovell, III (Inspector General of the DOT) of 11 September 2014

Dear Mr. Ditlow:

I had forwarded *Reference 1* to Mr. Calvin L. Scovell, the Inspector General of the Department of Transportation. *Reference 2* was signed-for by his office in Washington on 12 September 2014.

PERSPECTIVE

The CAS petition of October 2009 requested investigation of Jeep fuel system crashworthiness. It involved detailed safety data and concepts spanning decades, taking several months to complete. Your follow-up has been voluminous. My assistance in support of the petition spans six years. *Reference 1* required weeks of effort. However, Mr. Scovell made an “independent judgment” regarding these complex matters in just a few days . . . pronouncing:

“We are unable to reply to further communications on this matter. (*Subject 1*)”

The DOT OIG response is dismissive and diversionary (ATTACHMENT 1). Characteristically, it also failed to forward a copy to CAS; an open cc to *Reference 2*. I am compelled to fill-in that rudimentary courtesy in behalf of the taxpayer.

DEDICATION



The inveracity that the taxpayer has experienced from the relevant organizations in response to your petition is nothing short of outrageous. The events that led up to, and followed the closure of the NHTSA investigation are nothing short of criminal.

Were these issues trivial, *Subject 1* would be derided as diatribe. Indeed, after submitting *Reference 1* my person endured the usual derision.

But none of our travails can compare, at any level, to that endured by an expecting 23-year-old mother who burned to death in a Jeep, in a foreseeable low speed accident, here in Michigan on 11 November 2014.

Therefore, *Subject 1* is now dedicated to the life that was taken from Ms. Kayla Lucille White, and the ongoing agony that is being endured by her family, fiancé and friends.

REVIEW

Reference 1 was written mere months prior to the manslaughter of Ms. White. It detailed both historical and *Subject 1* related criminal behavior committed by the organizations headed by the individuals pictured here:



From left, former Secretary of the Department of Transportation (DOT) Raymond LaHood, former Administrator of the National Highway Traffic Safety Administration (NHTSA) Mr. David Strickland, and current Fiat Chrysler Automobiles (FCA) Chairman Sergio Marchionne.

These individuals were relied upon to rectify Jeep fuel system crashworthiness, and were trusted with the responsibility to offer a competent and verified remedy. These duties are not a matter of volition, it is the law. However, the remedy that LaHood, Strickland and Marchionne agreed to, from behind closed doors in June 2013, without the contemporaneous input of CAS, was not merely incompetent; it was known by them to be a fraud. Since this fraudulent behavior continues to endanger the public, and is the direct cause of the death of Ms. White, this activity constitutes both conspiracy and gross criminal negligence. *Reference 1*, which was dismissed by Mr. Scovell, documents these facts in great detail.

DISCUSSION AND CONTEXTUAL COMPARISON

The 2 July 2014 letter from NHTSA Chief Counsel O. Kevin Vincent was sent to FCA after the secret Chicago meeting of LaHood, Strickland and Marchionne in June 2013 (ATTACHMENT 2). But, as previously detailed on page 10 of *Reference 1*, this ‘*Special Order Directed to Chrysler Group LLC*’ confirms that LaHood, Strickland and Marchionne had no honest basis to publically claim that their “trailer hitch remedy” was a verified fix for the Jeep fuel system crashworthiness defect. The Vincent letter, which was not openly shared with the public, states:

“In response to ODI’s concerns, Chrysler provided drawings of the hitches and a limited set of test data. In ODI’s view the test data provided by Chrysler was insufficient. However, when asked, Chrysler indicated that it would not conduct any testing or supply more data.” (underline added)

This “*not conduct any testing*” fact **cannot** be dismissed as mere laziness or lack of due-care; it is in violation of the spirit if not the letter of the United States Transportation Safety Act.

This violation of law needs to be analyzed in the context of a comparative example. I am personally familiar with this example, which serves as stark contrast to the criminal behavior that led to the death of Ms. White:

Chrysler was aware of the facts I discuss next, PRIOR to their fraudulent “trailer hitch remedy” of June 2013. This awareness occurred through my expert reports and depositions in Jeep fire death and injury litigations,

NHTSA was aware of these comparative facts PRIOR to their complicity with the “trailer hitch remedy” through my formal and continuous one-on-one contact during the CAS petition investigation (EA12-005),

This context is derived from the long-standing industry practice of thoroughly testing a remedy, and making those test results public, PRIOR to announcing to NHTSA and the public that the remedy is indeed viable and verified,

The following context includes the standard practice of establishing dealership availability (of components that comprise the competent remedy) PRIOR to insinuating availability in the public domain.

This contextual comparison involves the Ford Crown Victoria police cruiser fuel tank crashworthiness investigation.

DISCUSSION AND CONTEXT COMPARISON – cont.

CROWN VICTORIA POLICE INTERCEPTOR (CVPI) PACKAGE OPTIONAL UPGRADE KIT		
AFFECTED VEHICLES: CERTAIN 1992 THROUGH 2003 MODEL YEAR CROWN VICTORIA POLICE INTERCEPTOR (CVPI) VEHICLES CURRENTLY IN POLICE DUTY		
2003 MODEL YEAR VEHICLES SERVICE PART NUMBER 3W7Z-9B007-AA KIT CONTENTS:		
Part Number	Description	Quantity
-9N070	Shield, Fuel Tank Strap – RH	1
-9C170	Shield, Fuel Tank Strap – LH	2
-9F935	Pads, Canister Buffer	5
W704369-S309	Rivet, Carbon Canister	1
-4C036	Shield, Differential	3
-4346	Bolt, Differential Shield Hex Head	1
-4A389	Shield Assembly, Axle – RH	1
-4C035	Shield Assembly, Axle – LH	1
-19G376	Instruction Sheet	1
1998-2002 MODEL YEAR VEHICLES SERVICE PART NUMBER 3W7Z-9B007-BA KIT CONTENTS:		
Part Number	Description	Quantity
-9N070	Shield, Fuel Tank Strap – RH	1
-9C170	Shield, Fuel Tank Strap – LH	2
-9F935	Pads, Canister Buffer	5
W704369-S309	Rivet, Carbon Canister	1
-4C036	Shield, Differential	3
-4346	Bolt, Differential Shield Hex Head	1
-4A389	Shield Assembly, Axle – RH	1
-4C035	Shield Assembly, Axle – LH	1
W709585S-300	Strap, Tie	2
-19G376	Instruction Sheet	1
1992-1997 MODEL YEAR VEHICLES SERVICE PART NUMBER 3W7Z-9B007-CA KIT CONTENTS:		
Part Number	Description	Quantity

Pictured above is my 1997 Ford Crown Victoria, parked in my driveway in Dearborn, Michigan. Positioned at the rear is the fuel tank crashworthiness remedy that was provided by Ford Motor Company. These components are the result of a NHTSA defect investigation that concluded in 2003. Called the “Crown Victoria Police Interceptor (CVPI) Upgrade Kit,” this system was claimed to offer fuel system crashworthiness protection for collision speeds up to 65 mph.

As Chrysler and NHTSA are fully aware, I retrofitted my Ford with the CVPI Upgrade Kit; in my driveway with hand tools. This was known to NHTSA/Chrysler not later than 2 January 2012 (ATTACHMENT 3)

Let us now detail preliminary comparisons between the CVPI investigation and the DOT/NHTSA/Chrysler closure of the Jeep EA12-005 investigation . . . **and how such relates to the manslaughter of Ms. White:**

At no time during the CVPI investigation was NHTSA complicit-with or did Ford brazenly declare it would “***not conduct any testing.***” Quite the contrary, and emphasizing this comparative point, the Ford testing of the CVPI upgrade was extensive,

Alternatively (at the time they pronounced closure of EA12-005) DOT, NHTSA and Chrysler never explained that their “trailer hitch remedy” had never been tested!

At no time did Chrysler openly concede to Ms. White that they had not, and will “***not conduct any testing!***”

At no time did DOT/NHTSA/Chrysler openly concede to Ms. White that her life was in danger from an established safety defect, that they jointly knew dated to as early as 24 August 1978 (ATTACHMENT 4),

At no time did DOT/NHTSA/Chrysler openly concede to Ms. White that the safety defect in her Jeep did NOT require the continuous lie spewed by Chrysler defense lawyers and public relations staff; that she was only in danger from but could not be protected during “*high speed high energy*” collisions,

At no time did DOT/NHTSA/Chrysler concede to Ms. White that they were aware of several tests conducted by CAS on the Ford Explorer, at 70 and 75 mph, and that no fuel leakage or fire risk occurred,

At no time did DOT/NHTSA/Chrysler concede to Ms. White that the undersigned had recommended, in not less than eight EA12-005 letters, that alternative technology and components existed that would “encapsulate” her Jeep Liberty fuel tank, and offer crashworthiness comparable to the collision speeds protected by the CVPI upgrade,

In stark contrast, at no time was DOT/NHTSA/Chrysler in a position to assert to Ms. White that a verified remedy would be available at the Chrysler dealership, that she had consulted . . . **PRIOR to her being burned to death.**

THE MANSLAUGHTER OF MS. KAYLA LUCILLE WHITE ON 11 NOVEMBER 2014

Pictured below is a photograph of the 2003 Jeep Liberty inferno of 11 November 2014. As this picture was taken, a waitress and her unborn child were burning to death. Ms. White was mere minutes from her place of work:



In *Reference 1* Mr. Scovell would find my July 2014 interview with WNDU-16 NBC News in South Bend, Indiana. I stated concerns regarding the fraudulent DOT/NHTSA/Chrysler announcement about availability of a competent remedy at Chrysler dealerships:

“The fact that they were not ready to go into mass production of the remedy within weeks of the announcement in June of last year, tells you that they don’t feel any sense of urgency, and they don’t feel any sense of moral commitment to those that were subsequently killed.”

But I continued with a chilling prediction, which I asserted mere months prior to the picture above:

“No matter how small the probably of the fire death event is, Chrysler and NHTSA are deciding that the roll of dice is what constitutes safety, not the competent and urgent retrofitting of a competent remedy.

So, the bottom line is, more deaths and more injuries are going to occur.”

With these facts in mind, and in the context of the comparative CVPI example, we review for Mr. Scovell what I presented in *Reference 1*, the gross criminal negligence law:

“Gross negligence is culpable or criminal when accompanied by acts of commission or omission of a wanton or wilful nature, showing a reckless or indifferent disregard of the rights of others, under circumstances reasonably calculated to produce injury, or which make it not improbable that injury will be occasioned, and the offender knows, or is charged with the knowledge of, the probable result of his acts.”

I am confident that a jury will assess that Mr. LaHood, Mr. Strickland, and Mr. Marchionne were “*charged with the knowledge,*” and that their “*acts of commission and omission*” made the manslaughter of Ms. White “*not improbable.*”

THE MANSLAUGHTER OF MS. KAYLA LUCILLE WHITE ON 11 NOVEMBER 2014 – cont.



As demonstrated on ATTACHMENT 1, Mr. Scovell too has zero competence regarding the future realities and complexities rendered by the type of safety defect that the CAS petition attempted to address and correct.

Mere days after receipt, but prior to the horrific death of the young lady pictured at left, Mr. Scovell scoffed at *Reference 1*, declaring that it:

“ . . . do(es) not warrant a formal Department of Transportation Office of Inspector General investigation / inquiry.”

I am confident that if the last name on the accident and autopsy reports, concerning 11 November 2014, was that of a young lady named “Scovell” or “LaHood” or “Strickland” or “Marchionne,” the DOT Inspector General would have had a *“sense of urgency . . . and a sense of moral commitment.”*

You will note from the accident report that the only person suffering serious injury was the driver of a Jeep. Everyone else involved in the accident of 11 November 2014 went home that night (ATTACHMENT 5).

You will note from the autopsy report that the cause of death had absolutely nothing to do with the *“high speed high energy”* lie that is constantly spewed by Chrysler defense lawyers and public relations staff. The collision energy was so low, that no injuries resulted from physical force trauma, not even to the unborn child in the womb. The autopsy confirms that the life taken from Ms. Kayla Lucille White was a direct result of the *“fundamental safety defect”* contained in the Jeep fuel system, and by the *“acts of commission and omission”* by Mr. LaHood, Mr. Strickland, and Mr. Marchionne (ATTACHMENT 6).

CONCLUSION

One conclusion that is overwhelming is the demonstrated and documented fact that selected automobile manufacturers and their subordinates in the Obama Administration cannot be trusted to act competently or responsibly when entrusted with the all-important priority of human safety.

Again, in view of the gross criminal negligence law . . .

“Gross negligence is culpable or criminal when accompanied by acts of commission or omission of a wanton or wilful nature, showing a reckless or indifferent disregard of the rights of others, under circumstances reasonably calculated to produce injury, or which make it not improbable that injury will be occasioned, and the offender knows, or is charged with the knowledge of, the probable result of his acts.”

. . . I am confident that a jury will assess that Mr. LaHood, Mr. Strickland, and Mr. Marchionne were “*charged with the knowledge,*” and that their “*acts of commission and omission*” made the manslaughter of Ms. White “*not improbable.*”

But given ATTACHMENT 1, it is clear that the Department of Transportation (DOT) and the National Highway Traffic Safety Administration (NHTSA) cannot be relied on to “police” themselves. Per Mr. Scovell’s admonition, we must seek that fundamental operative elsewhere.

REQUEST

Please note that in addition to Mr. Eric Holder, the current United States Attorney General, I am also forwarding this letter to Ms. Loretta E. Lynch of the United States Attorney's Office. The senatorial confirmation of President Obama’s nomination of Ms. Lynch to replace Mr. Holder is pending.

My preliminary request to you as Director of the Center for Auto Safety is that you consider the portent of *Subject 1* and *Subject 2*, forwarding such, under your cover, for review and consideration by the appropriate members of in the United States Congress, the United States Senate, and the U.S. Department of Justice.

Please do not hesitate to contact me at any time.

Respectfully,

Paul V. Sheridan

ENDNOTES

Reference 1: My Letter to Center for Auto Safety (CAS) of 20 August 2014:

<http://pvsheridan.com/Sheridan2Ditlow-3-20Aug2014.pdf>

Reference 2: My Letter to Calvin L. Scovell, III (Inspector General of the DOT) of 11 September 2014

<http://pvsheridan.com/Sheridan2Scovell-1-11Sep2014.pdf>

CAS petition of October 2009

<http://pvsheridan.com/JeepGrandCherokeeDefectPetition.pdf>

The manslaughter of Ms. Kayla Lucille White of 11 November 2014

<https://www.youtube.com/watch?v=trhw7MM34mU>

My July 2014 interview with WNDU-16 NBC News in South Bend, Indiana:

“The fact that they were not ready to go into mass production of the remedy within weeks of the announcement in June of last year, tells you that they don’t feel any sense of urgency, and they don’t feel any sense of moral commitment to those that were subsequently killed.”

“No matter how small the probability of the fire death event is, Chrysler and NHTSA are deciding that the roll of dice is what constitutes safety, not the competent and urgent retrofitting of a competent remedy.

So, the bottom line is, more deaths and more injuries are going to occur.”

My interview quote of July 2014 is here (@ 2:45):

<https://www.youtube.com/watch?v=Mw07BU3g4ZY>

ATTACHMENT 1

Mr. Clarence M. Ditlow, Director
Center for Auto Safety
Suite 330
1825 Connecticut Ave, NW
Washington, DC 20009-5708
(202) 328-7700

12 February 2015

Subject 1: Criminal Investigation of DOT, NHTSA and FCA (Re: Closure of EA12-005)
Subject 2: The Manslaughter of Ms. Kayla Lucille White on 11 November 2014

One Page

Letter from the Office of DOT Inspector General Calvin L. Scovell to Paul V. Sheridan, dated 26 September 2014.



U.S. Department of
Transportation

Office of Inspector General
Washington, D.C. 20590

Office of the Secretary
of Transportation

September 26, 2014

Mr. Paul Sheridan
22357 Columbia Street
Dearborn, Michigan 48124-3431

Dear Mr. Sheridan:

This letter is in response to your recent correspondence to the U.S. Department of Transportation, Office of Inspector General (OIG). You are reporting concerns related to Fiat Chrysler Automobiles and NHTSA EA12-005.

The OIG exercises independent judgment in determining the best use of available resources to meet our responsibilities under the Inspector General Act. We have carefully reviewed the material you provided, determined that your concerns do not warrant a formal OIG Investigation/Inquiry, and the appropriate venue may lie with other established procedures. Therefore, our file is now closed and we are unable to reply to further communications regarding this matter.

We appreciate your efforts to prevent government waste, fraud, and abuse. Thank you for providing us the opportunity to look into this matter.

Sincerely,

Scott Harding
Chief, Complaint Center Operations

ATTACHMENT 2

Mr. Clarence M. Ditlow, Director
Center for Auto Safety
Suite 330
1825 Connecticut Ave, NW
Washington, DC 20009-5708
(202) 328-7700

12 February 2015

Subject 1: Criminal Investigation of DOT, NHTSA and FCA (Re: Closure of EA12-005)
Subject 2: The Manslaughter of Ms. Kayla Lucille White on 11 November 2014

Twelve Pages

The 2 July 2014 letter from NHTSA Chief Counsel O. Kevin Vincent was sent to FCA after the secret Chicago meeting of LaHood, Strickland and Marchionne in June 2013. But this *'Special Order Directed to Chrysler Group LLC'* confirms that LaHood, Strickland and Marchionne had no honest basis to publically claim that their "trailer hitch remedy" was a verified fix for the Jeep fuel system crashworthiness defect. The Vincent letter, which was not openly shared with the public, states:

"In response to ODIs concerns, Chrysler provided drawings of the hitches and a limited set of test data. In ODIs view the test data provided by Chrysler was insufficient. However, when asked, Chrysler indicated that it would not conduct any testing or supply more data." (underline added)

**UNITED STATES DEPARTMENT OF TRANSPORTATION
NATIONAL HIGHWAY TRAFFIC SAFETY ADMINISTRATION**

1200 New Jersey Avenue, SE
West Building, W41-326
Washington, DC 20590

In re:)
)
EA12-005)
NHTSA Recall No. 13V-252)
)

SPECIAL ORDER DIRECTED TO CHRYSLER GROUP LLC

To:

Reginald Modlin, Director
Regulatory Affairs
Chrysler Group LLC
800 Chrysler Drive, CIMS 482-00-91
Auburn Hills, MI 48326-2757

This Special Order is issued by the Secretary of Transportation pursuant to 49 U.S.C. § 30166(g)(1)(A) and 49 C.F.R. §§ 510.7 and 510.8, and pursuant to a delegation of authority to the Chief Counsel of the National Highway Traffic Safety Administration (“NHTSA”), an Operating Administration of the United States Department of Transportation.

On June 18, 2013, Chrysler Group LLC (“Chrysler”) notified NHTSA that it agreed to conduct a voluntary recall of approximately 1,560,000 model year (“MY”) 2002-2007 Jeep Liberty (KJ) and MY 1993-1998 Jeep Grand Cherokee (ZJ) vehicles. Chrysler further stated that it would conduct a voluntary service campaign directed at an undisclosed number of MY 1999-2004 Jeep Grand Cherokee (WJ) vehicles. Chrysler’s report (“Part 573 Report”) stated that Chrysler would notify its customers of the safety recall for the Jeep Grand Cherokee (ZJ) and the Jeep Liberty (KJ) following the notification procedures contained in Section 577.7 of the

agency's regulations, and provide six quarterly reports of campaign completion, consistent with Section 573.7 of the agency's regulations. NHTSA has designated this recall as NHTSA Recall No. 13V-252.

Chrysler's June 18, 2013 Part 573 Report pledged that Chrysler would provide a structural improvement to the MY 1993-1998 Jeep Grand Cherokee (ZJ) and MY 2002-2007 Jeep Liberty (KJ) to mitigate the risks of fuel leaks in low-speed collisions. To that end, Chrysler stated it would take the following actions:

1. Written notification to all owners inviting them to bring in their vehicles for a free inspection of the rear structure
2. For any affected vehicle that has no trailer hitch, a Chrysler trailer hitch will be installed free of charge, provided the condition of the vehicle can support proper installation
3. For any affected vehicle that has an aftermarket trailer hitch, the area surrounding the installation will be inspected for any evidence of sharp edges or other puncture risks. If any such issues are identified, a Chrysler trailer hitch will be installed free of charge, provided the condition of the vehicle can support proper installation
4. For any affected vehicle that has an original equipment trailer hitch installed, the area around the installation will be inspected and, if no installation problems are identified, the vehicle will be released. If the inspection identifies an installation issue, it will be remedied free of charge.

Shortly after receipt of Chrysler's June 18, 2013 Part 573 Report, Chrysler officials and members of NHTSA's Office of Defects Investigation (ODI) began discussions centering on the effectiveness of Chrysler's proposed remedy. Although ODI staff agreed that addition of the trailer hitches would, as a general proposition, stiffen the rear structure of the vehicles, ODI remained concerned about the ability of the hitches to mitigate the risk of fire in low and moderate speed rear impacts. In response to ODI's concerns, Chrysler provided drawings of the hitches and a limited set of test data. In ODI's view, the test data provided by Chrysler was

insufficient. However, when asked, Chrysler indicated that it would not conduct any testing or supply more data.

Due to concerns about the effectiveness of the proposed remedy, particularly in light of the safety risks posed by rear-impact fuel leaks and fires, NHTSA decided to take the unusual step of conducting its own test program to assess the performance of the hitch in mitigating the risk of fuel leaks and fire in rear crashes. The NHTSA test program, which involved a series of eight rear impact crash reconstruction tests, was initiated on August 22, 2013 and concluded on January 2, 2014. After reviewing the results of this test program, NHTSA informed Chrysler on January 13, 2014 that it did not have any reservations about implementation of Chrysler's proposed remedy.

Chrysler and NHTSA began a series of discussions regarding implementation of the remedy campaign following ODI's decision that testing appeared to demonstrate the effectiveness of the trailer hitch. These discussions revealed Chrysler had waited until December 6, 2013, to select a hitch supplier and did not issue a purchase order to the hitch supplier until January 29, 2014. Chrysler reported that the first run of hitches was produced on May 14, 2014. On June 11, 2014, Chrysler reported that it would produce 1,323 KJ hitches per day and 882 ZJ hitches per day and anticipated that it would have a stockpile of over 89,000 KJ hitches and 50,000 ZJ hitches by the August 1, 2014 recall repair launch. Chrysler further stated that it would maintain this production schedule unless demand dictated otherwise.

Chrysler's June 18, 2013 Part 573 Report estimated that the safety recall would encompass approximately 1,560,000 vehicles. In recent reports provided to ODI, Chrysler states that intends to send recall notification letters to 1,515,000 MY 1993-1998 Jeep Grand Cherokee (ZJ) owners and 995,000 MY 2002-2007 Jeep Liberty (KJ) owners. Assuming that all of these

owners will respond to the notification, it will take Chrysler at least 4.7 years and 2.06 years respectively to produce the required number of Grand Cherokee and Liberty hitches at the current rate of production. In the event that only half of the notified Grand Cherokee owners respond to the notice and have the remedy installed, it would take Chrysler well over two years to produce the required parts at its present schedule.

NHTSA is therefore concerned that Chrysler does not have, and will not have, sufficient production capacity to ensure that enough hitches will be available to ensure that the recalled vehicles will be remedied expeditiously. For many owners, a recall remedy deferred by parts availability easily becomes a defect remedy denied. Moreover, additional delays in implementing this recall will inure to Chrysler's benefit at the expense of vehicle owner safety. Although NHTSA acknowledges that recall campaigns may have low completion rates for any number of reasons, the agency has no intention of allowing Chrysler, or any other manufacturer, to delay recall completion to the detriment of safety. NHTSA is therefore issuing this Special Order to obtain information regarding Chrysler's data collection, planning and decision-making in regard to its implementation of the recall remedy in this case.

Chrysler's response to this Special Order must be provided by **July 16, 2014**. Chrysler's response must be signed under oath, i.e., accompanied by an affidavit, signed by a responsible officer of Chrysler, stating that he/she has undertaken and directed an inquiry reasonably calculated to assure that the answers and production of documents are complete and correct, that he/she has caused the documents of Chrysler to be searched diligently for information and documents responsive to this Special Order and produced them to NHTSA, and that the answers to the inquiries provided to NHTSA respond completely and correctly to this Special Order. 49 U.S.C. § 30166(g)(1)(A); 49 C.F.R. § 510.7. Failure to respond fully or truthfully to this Special

Order may result in a referral to the United States Department of Justice for a civil action to compel responses, and may subject Chrysler to civil penalties of up to \$7,000 per day, up to a maximum penalty of \$35,000,000 for a related series of daily violations. 49 U.S.C.

§§ 30163(a)(1), 30165(a)(3); 49 C.F.R. § 578.6(a)(3). Falsifying or withholding information in response to this Special Order may also lead to criminal penalties of a fine or imprisonment of up to 15 years, or both. 49 U.S.C. § 30170(a)(1).

DEFINITIONS

To the extent used in this Special Order, the following definitions apply:

1. **“Affiliates”** means a corporation that is related to another corporation (such as a subsidiary, parent, or sibling corporation) by shareholdings or other means of control.
2. **“Agent”** means an individual, such as a representative, who is authorized to act for or in place of another.
3. **“Defect”** or **“Defect condition”** means the defect that is the subject of NHTSA Recall No. 13V-252.
4. **“Describe”** means to provide, with respect to any act, occurrence, transaction, event, statement, communication, or conduct (hereinafter, collectively, “act”), all facts concerning any such act, including, but not limited to, a description of each act, and the date, the location, and the names and addresses of all persons involved.
5. **“Document(s)”** is used in the broadest sense of the word under Rule 34 of the Federal Rules of Civil Procedure, and includes all original written, printed, typed, recorded, or graphic matter whatsoever, however produced or reproduced, of every kind, nature, and description, and all non-identical copies of both sides thereof, including, but not limited to, papers, letters, memoranda, correspondence, electronic communications (existing in hard copy

and/or in electronic storage), invoices, contracts, agreements, manuals, publications, photographs of all types, and all mechanical, magnetic, and electronic records or recordings of any kind. Any document, record, graph, chart, film or photograph originally produced in color must be provided in color. Furnish all documents whether verified by the manufacturer or not. If a document is not in the English language, provide both the original document and an English translation of the document.

6. **“Employee”** means a person who works in the service of another person (the employer) under an express or implied contract of hire, under which the employer has the right to control the details of work performance.

7. **“Chrysler”** means Chrysler Group LLC, its predecessors, all of their past and present officers and employees, whether assigned to their principal offices or any of their field or other locations, including all of their divisions, subsidiaries (whether or not incorporated) and affiliated enterprises and all of their headquarters, regional, zone and other offices and their employees, and all agents, contractors, consultants, attorneys and law firms and other persons engaged directly or indirectly (e.g., employee of a consultant) by or under the control of Chrysler (including all business units and persons previously referred to).

8. **“Identify”, “identity” or “identification,”** with respect to a person, means to provide that person’s name, title or position, employer, and last known business address and telephone number. With respect to a document, means the date (or time period covered if not dated), nature of document, author, and recipient(s). With respect to a business, means to provide the corporate address, name of its principals, telephone number, and name and address of the agent for service. With respect to a website, means the url of the site, the name and address of the owner of the site and the name and address of administrator of the website.

9. **“Subject Trailer Hitch”** means the trailer hitch being offered as a remedy in the vehicles subject to NHTSA Recall No. 13V-252.

10. **“Officer”** means a person who holds an office of trust, authority, or command, such as a person elected or appointed by the board of directors to manage the daily operations of a corporation, such as a CEO, president, secretary, or treasurer.

11. **“Recall”** means NHTSA Recall No. 13V-252.

12. **“Subject vehicle(s)”** means the vehicles subject to NHTSA Recall No. 13V-252.

13. **Other Terms.** To the extent that they are used in these requests, the terms “claim,” “consumer complaint,” “dealer field report,” “field report,” “fleet,” “good will,” “make,” “model,” “model year,” “notice,” “type,” “warranty,” “warranty adjustment,” and “warranty claim,” whether used in singular or in plural form, have the same meaning as found in 49 C.F.R. § 579.4.

INSTRUCTIONS

1. Your response to the Special Order shall be sent to Office of the Chief Counsel (NCC-111), National Highway Traffic Safety Administration, West Building, W41-326, 1200 New Jersey Avenue, SE, Washington, DC 20590.

2. Please repeat the applicable request verbatim above your response. After your response to each request, identify the source of the information and indicate the last date the information was gathered.

3. When documents are produced and the documents would not, standing alone, be self-explanatory, the production of documents shall be supplemented and accompanied by explanation. Please also be reminded that where a document responsive to a request is not in the English language, both the original document and an English translation of the document must

be produced.

4. You are required to respond to every request listed in this Special Order. If you cannot respond to any specific request or subpart(s) thereof, please state the reason why you are unable to do so. If you are unable to respond because you do not have all or any of the precise information needed to respond, provide an estimate. If, on the basis of attorney-client, attorney work product, or other privilege, you do not submit one or more requested documents or items of information in response to this Special Order, you must provide a privilege log identifying each document or item withheld, and stating the date, subject or title, name and position of the person(s) from, and the person(s) to whom it was sent, and the name and position of any other recipient (to include all carbon copies or blind carbon copies), the nature of that information or material, and the basis for the claim of privilege and why that privilege applies.

5. The response to this Special Order, including the document requests, must be submitted in duplicate, together with a copy of any confidentiality request, to this office by the deadline stated above.

6. If you claim that any of the information or documents provided in response to this Special Order constitutes confidential commercial material within the meaning of 5 U.S.C. § 552(b)(4), or is protected from disclosure pursuant to 18 U.S.C. § 1905, you must submit supporting information together with the materials that are the subject of the confidentiality request, in accordance with 49 C.F.R. Part 512, to the Office of Chief Counsel (NCC-111), National Highway Traffic Safety Administration, West Building, W41-326, 1200 New Jersey Avenue, SE, Washington, DC 20590. You are required to submit two copies of the documents containing allegedly confidential information and one copy of the documents from which information claimed to be confidential has been deleted. Failure to adhere to the requirements of

49 C.F.R. Part 512 will result in a rejection of your request for confidential treatment.

7. The singular includes the plural; the plural includes the singular. The masculine gender includes the feminine and neuter genders; and the neuter gender includes the masculine and feminine genders. “And” as well as “or” shall be construed either disjunctively or conjunctively, to bring within the scope of this Special Order all responses that might otherwise be construed to be outside its scope. “Each” shall be construed to include “every” and “every” shall be construed to include “each.” “Any” shall be construed to include “all” and “all” shall be construed to include “any.” The use of a verb in any tense shall be construed as the use of the verb in a past or present tense, whenever necessary to bring within the scope of the document requests all responses which might otherwise be construed to be outside its scope.

8. Chrysler’s response to this Special Order must be under oath, i.e., accompanied by an affidavit, signed by a responsible officer of Chrysler, stating that he/she has undertaken and directed an inquiry reasonably calculated to assure that the answers and production of documents are complete and correct, that he/she has caused the documents of Chrysler to be searched diligently for information and documents responsive to this Special Order and produced them to NHTSA, and that the answers to the inquiries provided to NHTSA respond completely and correctly to this Special Order.

REQUESTS

1. Separately for each model and model year vehicle provide Chrysler’s count of vehicles currently registered for use on the public roads of the various states and territories of the United States.

2. Separately for each model and model year vehicle provide Chrysler's count of owner notification letters that Chrysler will send owners pursuant to 49 CFR Part 577 and its schedule for mailing these letters.
3. Separately for each model provide Chrysler's analysis of the anticipated recall remedy completion rate including, but not limited to:
 - a. Any and all financial projections and/or financial reserves associated with completion of recall 13V-252.
 - b. Any and all analyses of the projected owner demand for the remedy.
 - c. The relationship between parts availability and recall remedy completion rates including the impact of wait times on owner behavior in this instance and safety recalls in general.
 - d. The extent to which the anticipated completion rate in 13V-252 differs from completion rates commonly established by Chrysler as targets in safety recalls.
4. State whether it is Chrysler's common practice to rely on a single supplier for critical components in production vehicles. If the answer to the foregoing is in the negative, please state why Chrysler is relying on a single supplier with tooling and welding jigs capable of fabricating only 1,323 KJ hitches per day and 882 ZJ hitches per day.
5. Provide Chrysler's analysis of the number of suppliers in the United States, Canada and Mexico with the capability of manufacturing the subject trailer hitches to Chrysler's specifications. Identify each such supplier and Chrysler's estimate of that supplier's production capacity.

6. Provide any and all analyses supporting Chrysler's determination that production of 1,323 KJ hitches per day and 882 ZJ hitches per day will be adequate to provide a remedy for the subject vehicles within the following time periods:
 - a. 7 days after the owner requests that the remedy be provided or otherwise presents the vehicle for repair.
 - b. 15 days after the owner requests that the remedy be provided or otherwise presents the vehicle for repair.
 - c. 30 days after the owner requests that the remedy be provided or otherwise presents the vehicle for repair.
 - d. For each of the foregoing responses, provide Chrysler's estimate of the percentage of vehicle owners seeking application of the remedy who could have their vehicles remedied within the allotted time.
7. Separately for each model provide Chrysler's analysis of the maximum production capacity of the supplier currently producing the subject trailer hitches. State whether the maximum production capacity of this supplier is sufficient to complete the recall campaign within eighteen months of August 1, 2014 if all owners receiving notification from Chrysler elect to have the remedy applied to their vehicles. If the answer to the foregoing is in the negative, state the percentage of owners who would be able to obtain the remedy within the aforementioned time period if the current supplier of the subject trailer hitch is working at maximum capacity.
8. Provide Chrysler's assessment of the lead time required to begin volume production of the subject trailer hitches by additional suppliers and the costs associated with producing the required tooling and welding jigs.

Dated: July 2, 2014

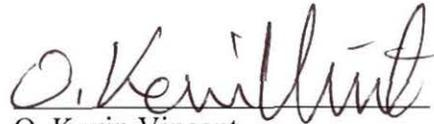
O. Kevin Vincent
Chief Counsel

ATTACHMENT 3

Mr. Clarence M. Ditlow, Director
Center for Auto Safety
Suite 330
1825 Connecticut Ave, NW
Washington, DC 20009-5708
(202) 328-7700

12 February 2015

Subject 1: Criminal Investigation of DOT, NHTSA and FCA (Re: Closure of EA12-005)
Subject 2: The Manslaughter of Ms. Kayla Lucille White on 11 November 2014

Seven Pages

Below is an exact duplicate of material submitted to Chrysler dealership and Chrysler defense lawyers, and the public record, in the Paul V. Sheridan expert reports in behalf of Jeep fire-death victim/plaintiffs such as Ms. Susan Kline.

This “*Crown Victoria Police Interceptor (CVPI) Upgrade Kit*” discussion and photographs have been known to Chrysler and NHTSA since not later than 2 January 2012; more than a year prior to pronouncement of their fraudulent “trailer hitch remedy” for the Jeep fuel system crashworthiness investigation (EA12-005).

ATTACHMENT T

EXPERT WITNESS REPORT - 2 January 2012 REVISION

Kline v. Loman Auto Group, Victoria Morgan-Alcala, et al.

Page Range 6

Pages 730 - 735

Defendant Lomans: Knowledge of Fuel System Defect Safety Recalls

On pages 20/21 of my Expert Witness Report - First Revision of 28 April 2011, I state

“O&C-3 In my expert experience I have personally/professionally examined the consumer response to safety recalls. This response rate, or yield, is dependant on the safety issue involved and, although the precise statistics are claimed to be a “trade secret” by the automotive industry, it is well-known that the highest safety defect recall yield by far correlates to customer notices that involve the elimination/reduction of a vehicle fire risk:

a. I am confident that if the SUSAN MORRIS KLINE family had been made aware of the salient facts contained in the main portion of this report and was offered, in a formal Chrysler recall, a retrofit that afforded the protection of a “Fuel Tank Skid Plate Shield,” they would have responded responsibly by having their 1996 Jeep Grand Cherokee retrofitted by a competent Jeep dealer (See ¶ 21-c-i):

i. The issuance-of and service response-to safety defect retrofit recalls is well-known to defendant Loman Auto Group. Approximately five years prior to the accident of February 24, 2007 that took the life of SUSAN MORRIS KLINE, defendant Loman Auto Group was notified of, and potentially performed fire-related retrofits of a competitive brand (e.g. Service Part Numbers 3W7Z-9B007-AA, 3W7Z-9B007-BA and 3W7Z-9B007-CA).”

The fuel tank on the “Panther” versions of the Ford Crown Victoria, Mercury Grand Marquis and Lincoln Town Car locate the fuel tank slightly aft and above the rear axle. These vehicles, in the police/emergency configuration, were part of a NHTSA defect investigation on the basis of rear end accident collisions that resulted in fuel tank failure, fire/explosions, and the severe burn injury or death of occupants. Unlike the ZJ-Body Jeep Grand Cherokee, these Panther fuel tanks are not exposed below the rear bumper, and are not subject to direct impact. However, in view of real-world facts, Ford voluntarily recalled the Panther vehicles for retrofit.

Ford through its dealerships, although officially making the retrofit available to police and emergency vehicles, will also provide for sale to the general public Service Part Numbers 3W7Z-9B007-AA, 3W7Z-9B007-BA and 3W7Z-9B007-CA. Ford dealership mechanics, such as those at Lomans Auto Group, can perform this retrofit in less than 30 minutes.

According to Ford this retrofit will provide fuel tank safety integrity up 65mph. This minimum level of protection should have been made available to the owners of the ZJ-Body Jeep Grand Cherokee, and retrofit to such levels was/is possible. In its current unprotected configuration, vehicles such as the 1996 Jeep Grand Cherokee, which were operated by Mrs. Susan Kline and serviced by Lomans, do not provide protection for very low speed impacts.

Regarding O&C-3-a-i, I have personally performed this retrofit on my 1997 Ford Crown Victoria vehicle, on my back in my driveway. This retrofit required simple hand tools, a floor jack and safety stands (Please see sub-attached photographs).



**CROWN VICTORIA POLICE INTERCEPTOR (CVPI)
PACKAGE OPTIONAL UPGRADE KIT**

AFFECTED VEHICLES: CERTAIN 1992 THROUGH 2003 MODEL YEAR CROWN VICTORIA
POLICE INTERCEPTOR (CVPI) VEHICLES
CURRENTLY IN POLICE DUTY

**2003 MODEL YEAR VEHICLES
SERVICE PART NUMBER 3W7Z-9B007-AA**

KIT CONTENTS:

<u>Part Number</u>	<u>Description</u>	<u>Quantity</u>
-9N070-	Shield, Fuel Tank Strap - RH	1
-9C170-	Shield, Fuel Tank Strap - LH	2
-9F935-	Pads, Canister Buffer	5
W704369-S309	Rivet, Carbon Canister	1
-4C036-	Shield, Differential	3
-4346-	Bolt, Differential Shield Hex Head	1
-4A389-	Shield Assembly, Axle - RH	1
-4C035-	Shield Assembly, Axle - LH	1
-19G376-	Instruction Sheet	1

**1998-2002 MODEL YEAR VEHICLES
SERVICE PART NUMBER 3W7Z-9B007-BA**

KIT CONTENTS:

<u>Part Number</u>	<u>Description</u>	<u>Quantity</u>
-9N070-	Shield, Fuel Tank Strap - RH	1
-9C170-	Shield, Fuel Tank Strap - LH	1
-9F935-	Pads, Canister Buffer	2
W704369-S309	Rivet, Carbon Canister	5
-4C036-	Shield, Differential	1
-4346-	Bolt, Differential Shield Hex Head	3
-4A389-	Shield Assembly, Axle - RH	1
-4C035-	Shield Assembly, Axle - LH	1
W709586S-300	Strap, Tie	2
-19G376-	Instruction Sheet	1

**1992-1997 MODEL YEAR VEHICLES
SERVICE PART NUMBER 3W7Z-9B007-CA**

KIT CONTENTS:

<u>Part Number</u>	<u>Description</u>	<u>Quantity</u>
-9N070-	Shield, Fuel Tank Strap - RH	1
-9C170-	Shield, Fuel Tank Strap - LH	2
-9F935-	Pads, Canister Buffer	5
W704369-S309	Rivet, Carbon Canister	1
-4C036-	Shield, Differential	3
-4346-	Bolt, Differential Shield Hex Head	1
-4A389-	Shield Assembly, Axle - RH	1
-4C035-	Shield Assembly, Axle - LH	1
-19G376-	Instruction Sheet	1



**CROWN VICTORIA POLICE INTERCEPTOR (CVP)
PACKAGE OPTIONAL UPGRADE KIT**

AFFECTED VEHICLES: CERTAIN 1992-1997 MODEL YEAR CROWN VICTORIA POLICE INTERCEPTOR (CVP) VEHICLES CURRENTLY IN POLICE DUTY

**2003 MODEL YEAR VEHICLES
SERVICE PART NUMBER 3N7Z-9B007-1A
KIT CONTENTS:**

Part Number	Description	Quantity
3N7Z-9B007-1A	Shield, Front Door - RH	1
3N7Z-9B007-1A	Shield, Front Door - LH	1
3N7Z-9B007-1A	Shield, Center Console	1
3N7Z-9B007-1A	Shield, Driver's Side Head	1
3N7Z-9B007-1A	Shield, Passenger Side Head	1
3N7Z-9B007-1A	Shield, Passenger Side - LH	1
3N7Z-9B007-1A	Shield, Driver Side	1
3N7Z-9B007-1A	Shield, Passenger Side	1

**1992-1997 MODEL YEAR VEHICLES
SERVICE PART NUMBER 3N7Z-9B007-1A
KIT CONTENTS:**

Part Number	Description	Quantity
3N7Z-9B007-1A	Shield, Front Door - RH	1
3N7Z-9B007-1A	Shield, Front Door - LH	1
3N7Z-9B007-1A	Shield, Center Console	1
3N7Z-9B007-1A	Shield, Driver's Side Head	1
3N7Z-9B007-1A	Shield, Passenger Side Head	1
3N7Z-9B007-1A	Shield, Passenger Side - LH	1
3N7Z-9B007-1A	Shield, Driver Side	1
3N7Z-9B007-1A	Shield, Passenger Side	1

**1992-1997 MODEL YEAR VEHICLES
SERVICE PART NUMBER 3N7Z-9B007-1A
KIT CONTENTS:**

Part Number	Description	Quantity
3N7Z-9B007-1A	Shield, Front Door - RH	1
3N7Z-9B007-1A	Shield, Front Door - LH	1
3N7Z-9B007-1A	Shield, Center Console	1
3N7Z-9B007-1A	Shield, Driver's Side Head	1
3N7Z-9B007-1A	Shield, Passenger Side Head	1
3N7Z-9B007-1A	Shield, Passenger Side - LH	1
3N7Z-9B007-1A	Shield, Driver Side	1
3N7Z-9B007-1A	Shield, Passenger Side	1

<ul style="list-style-type: none"> • BODY—PARTS AND PROCEDURE TO REDUCE THE POTENTIAL OF FUEL TANK PUNCTURES DURING RARE AND EXTREMELY HIGH-SPEED REAR IMPACTS • FUEL— PARTS AND PROCEDURE TO REDUCE THE POTENTIAL OF FUEL TANK PUNCTURES DURING RARE AND EXTREMELY HIGH-SPEED REAR IMPACTS 	<p align="center">Article No. 01-21-14</p>
---	---

FORD: 1992-2001 CROWN VICTORIA
LINCOLN: 1992-2001 TOWN CAR
MERCURY: 1992-2001 GRAND MARQUIS

ISSUE

This article is being issued to provide Service Parts and a Service Procedure to further reduce the unlikely possibility of a fuel tank puncture during an extremely high-speed rear impact in certain vehicle applications. Some Police agencies have indicated that their vehicles may stop along high-speed roads - which is prohibited by law except in emergency situations - and may thereby become exposed to extremely high-speed rear impacts, typically by drunk drivers.

Ford corporate guideline tests, at speeds 20 mph above government requirements, demonstrate excellent fuel tank integrity in these vehicles. Because of the nature of their use, some Police vehicles in certain applications may be exposed to extremely high-speed rear impacts with closing speeds above 80 mph. Investigation of several police vehicles involved in extreme high-speed rear impacts has identified a potential cause of the fuel tank puncture in at least one of these impacts.

ACTION

Recommended for vehicles exposed to extremely high-speed rear impacts. Refer to the following Service Procedure for details.

SERVICE PROCEDURE

1. On 1992-1997 vehicles, replace Park Brake Cable to Axle attaching hex head bolt part N806900-S2 with round-headed fastener part W706024-S427. Model year 1998 and later vehicles are of a different design and do not use this bolt (Figure 1).

2. On 1992-2001 vehicles, use a die grinder or electric grinder with suitable carbide or grinding wheel to remove the 4 mm high by 6 mm wide tab which protrudes down from one flange of the rear stabilizer bar axle attachment "U" bracket. There is a "U" bracket at each end of the center section of the rear stabilizer bar (Figure 2).

The "U" brackets do not need to be removed from the vehicle.

The tab should be ground until it is flush with the contour of the flange.

PART NUMBER	PART NAME
W706024-S427	Bolt - Round Headed Fastener

OTHER APPLICABLE ARTICLES: NONE
WARRANTY STATUS: Eligible Under The Provisions Of Bumper To Bumper Warranty Coverage

OPERATION	DESCRIPTION	TIME
012114A	Replace Park Brake Cable To Axle Attaching Hex Head Fastener With Round Headed Fastener, Then Grind Tab From Both U-Brackets On Rear Stabilizer Bar 1992-1997	0.4 Hr.
012114B	Grind Tab From Both U-Brackets On Rear Stabilizer Bar 1992-2001	0.2 Hr.

CRUZ
F 030541

1271

Article No. 01-21-14 Cont'd.

DEALER CODING

BASIC PART NO.

4A047

OASIS CODES: 111000, 404000, 509000

CONDITION

CODE

42

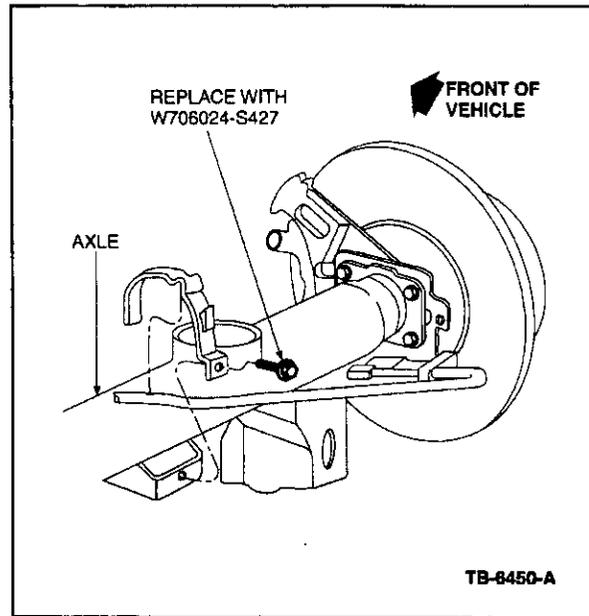

Figure 1 - Article 01-21-14

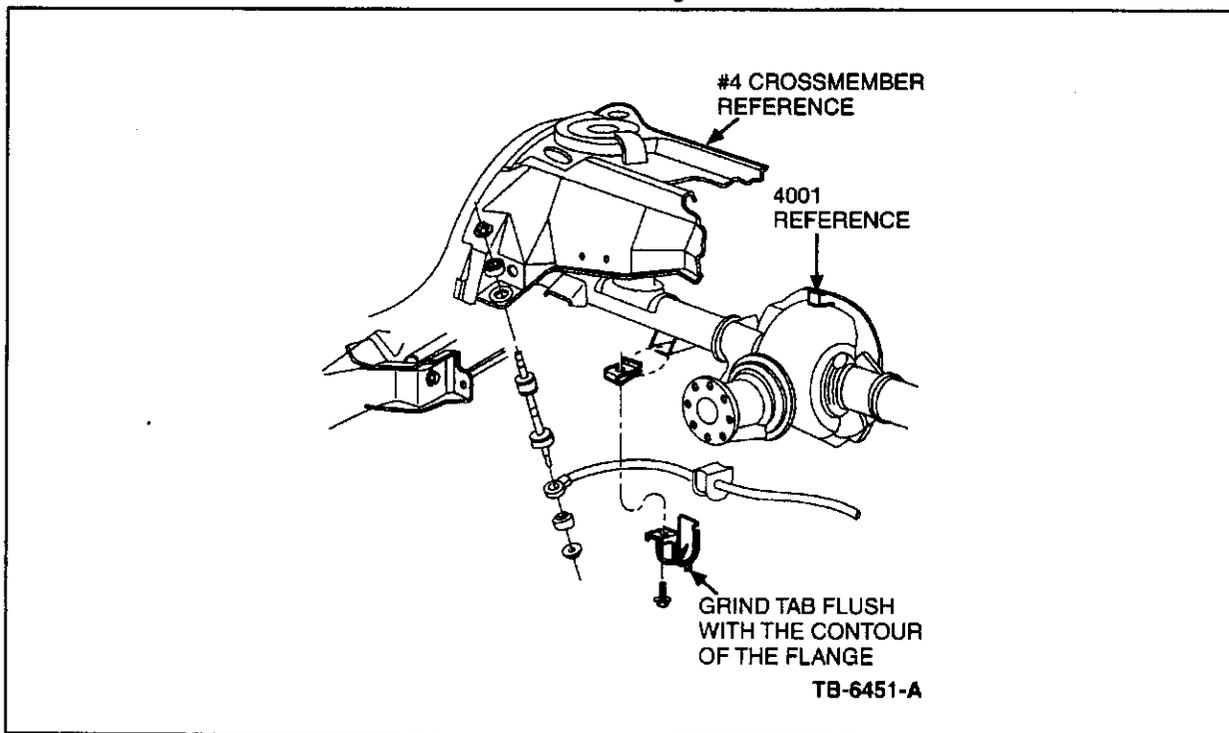

Figure 2 - Article 01-21-14

ATTACHMENT 4

Mr. Clarence M. Ditlow, Director
Center for Auto Safety
Suite 330
1825 Connecticut Ave, NW
Washington, DC 20009-5708
(202) 328-7700

12 February 2015

Subject 1: Criminal Investigation of DOT, NHTSA and FCA (Re: Closure of EA12-005)
Subject 2: The Manslaughter of Ms. Kayla Lucille White on 11 November 2014

Two Pages

L. L. Baker memo of 24 August 1978, sent to the highest levels of Chrysler executive management, regarding fuel system crashworthiness design issues.

Inter Company Correspondence

File Code

Date

August 24, 1978

Name & Department	Division	Plant/Office	CIMS Number
R. M. Sinclair, Director International Product Development	Product Plan. & Design Office	Chrysler Center	416-20-15
L. L. Baker, Manager Automotive Safety	Engineering Office	Chrysler Center	418-12-34

Subject: Fuel System Design - Chrysler Passenger Cars And Trucks.

Pursuant to the discussions between Messrs. Vining, Jeffe, Sperlich and yourself with Mr. Mochida on August 22, the fuel system design for domestic passenger cars and trucks is summarized for Mr. Mochida's information.

Not only are the impact performance requirements of MVSS-301 pertinent to the design approach but the significant increase in the last few years in the numbers of product liability cases involving fuel system fires and the increase in the size of the awards by sympathetic juries has to be recognized. In the Ford Pinto case the NHTSA Office of Defects Investigation selected arbitrary performance criteria of minimal or no fuel leakage when the test car is impacted in the rear by a full size car at 35 mph as a basis for questioning the safety of a recall modification of the Pinto.

• Passenger Car

Fuel Tank Location

The front wheel drive configuration in Chrysler's Omni and Horizon allowed the fuel tank to be located beneath the rear seat. This location provides the protection of all of the structure behind the rear wheels--as well as the rear wheels themselves--to protect the tank from being damaged in a collision. This same location will be used in the new 1981 K-Body cars which will also have a front wheel drive.

The rear wheel drive H-Body scheduled for introduction in 1983 will have the fuel tank located over the rear axle and beneath the floor pan.

The question of whether M, R or J-Body cars should be converted to tank over axle prior to their phase-out is a matter under intensive study at this time.

Filler Neck And Cap

As the fuel tank is moved to a more forward location, the fuel fill is moved to the side of the car. The fuel cap will be recessed below the body surface and a fuel fill door provided. The fuel filler neck is designed to break away from the car body with the fuel filler cap still in place.

In this design the filler cap and fill neck or fill tube remain with the tank to avoid separation and possible fuel leakage. This side fill is scheduled for J and M-Bodies in 1980 and the Y-car in 1981.

The fuel fill is less likely to be damaged in a sideswipe when located on the right side of the car. As new models are introduced, the fuel fill will be moved to the right side of the vehicle. This may also offer greater protection to drivers who run out of gasoline on the highway, since they will fill the tank on the side away from the traffic.

Structure

In 1979 through 1983, the M, R, and J model cars which have the fuel tank under the floor pan behind the rear wheels, structural reinforcement of the longitudinals on each side of the tank, shielding of any unfriendly surfaces adjacent to the tank, and the design of straps and hangers to limit undesired tank movement will be employed.

Truck

Fuel Tank Location

The same principles regarding fuel tank location apply to truck design. It is important that these larger fuel tanks are not only shielded from damage in a collision but do not break away from the truck and thereby spread fuel onto the roadway. The approach used by Mitsubishi on the SP-27 of locating the fuel tank ahead of the rear wheels appears to provide good protection for the tank.

The front wheel drive T-115 to be introduced in 1982 will have the fuel tank ahead of the rear wheels and under the rear seat. However, in rear wheel drive trucks there is no clearance over the axle for fuel tank installation and in many cases there is insufficient space ahead of the axle for fuel tanks of the desired capacity.

Chrysler is investigating fuel tank relocation ahead of the rear wheels for vans and multi-purpose vehicles, but present plans for pickups through 1983 and for MPV's and vans through 1985 have the fuel tank located behind the rear wheels. In vehicles both with and without bumpers there is a concern with vertical height differences that create a mismatch with passenger car bumpers. Where fuel tank location behind the rear axle is all that is feasible, a protective impact deflection structure may have to be provided whether or not a bumper is provided. An investigation whether to relocate the fuel tank or to provide impact deflecting structures is presently underway.

Fill Neck And Cap

All trucks and vans have side fill. The sweptline pickup truck (DW 1-3) and multi-purpose vehicles (AD-1 & AW-1) will have a recessed fill cap and fuel filler door beginning in 1981.

L. L. Baker

ATTACHMENT 5

Mr. Clarence M. Ditlow, Director
Center for Auto Safety
Suite 330
1825 Connecticut Ave, NW
Washington, DC 20009-5708
(202) 328-7700

12 February 2015

Subject 1: Criminal Investigation of DOT, NHTSA and FCA (Re: Closure of EA12-005)
Subject 2: The Manslaughter of Ms. Kayla Lucille White on 11 November 2014

Four Pages

State of Michigan Traffic Crash Report for 11 November 2014

Authority: 1949 PA 300, Sec.257 622
Compliance: Required MSP UD-10E
Penalty: \$100 and/or 90 days (Rev 11/2006)

External # 0250964
Crash ID 9099115

Page 01 of 02
Incident # 212450314 File Class 93001

STATE OF MICHIGAN TRAFFIC CRASH REPORT

ORI: MI 6302100 Department Name: MSP Metro North
Incident Disposition: Open
Reviewer: BRET SMITH

Crash Date: 11/11/2014 Crash Time: 16:38 No. of Units: 04 Crash Type: Rear End
Special Circumstances: School Bus None Hit and Run Deer Fleeing Police
Special Checks: Fatal Non-Traffic Area ORV/Snowmobile

County: 63 - Oakland Traffic Control: None Relation to Roadway: On Road Special Study: Weather: Clear Area: 06 - All other freeway areas

City/Twsp: 91 - Southfield Construction Zone (if applicable) Type: Lane Closed Activity: Light: Dusk Road Condition: Dry Total Lanes: 06 Speed Limit: 70 Posted: Yes

LOCATION
Prefix: Road Name: M-10 Road Type: FWY Suffix: Divided Roadway N
Distance: 1,320 Feet S Traffic Way: 03 - Divided Hwy with barrier Access Control: 02 - Full access control
Prefix: Intersecting Road: TELEGRAPH Road Type: RD Suffix: Divided Roadway

UNIT / DRIVER
Unit Number: 01 Unit Known: Yes State: MI Driver License Number: B000947014919 Date of Birth (Age): 12/02/1966 (47) License Type: Operator Endorsements: Cycle, Farm, Recreation Sex: F Total Occupants: 01 Hazardous Action: 00 - None

Unit Type: MV Driver Information: YAN BAI, 5692 STRATFORD DR, WEST BLOOMFIELD, MI 48322 (313) 300-8382 Injury: 0 Position: 01 Restraint: 04 Hospital: REFUSED

Driver Condition: 01-09 Interlock: No Ejected: Trapped: Airbag Deployed: No Ambulance: REFUSED

Alcohol: Yes, No, Refused, Not offered, Test Type, Field, PBT, Breath, Blood, Urine Test Results: Drugs: Yes, No, Test Type, Blood, Urine Test Results: Citation Issued: Hazardous, Other

Vehicle Registration: 9LGU70 State: MI Insurance / Policy #: FRANKENMUTH MUTUAL Towed To/By: NONE Special Vehicles: 0 Private Trailer Type: Vehicle Defect:

VIN: 5LMCJ1A97FUJ07523 Vehicle Description: LINCOLN Make: MKC Model: Color: WHI Year: 2015 Vehicle Type: Passenger Car

Location of Greatest Damage: 05 First Impact: 05 Extent of Damage: 2 Driveable: Yes Vehicle Direction: N Vehicle Use: 01 - Private Action Prior: 08 - Slowing/stop on roadway

Sequence of Events: First: 17 - Motor veh in transport Second: Third: Fourth:

PASSENGERS
Passenger Information: Date of Birth (Age), Sex, Position, Restraint, Hospital, Injury, Airbag Deployed, Ejected, Trapped, Ambulance

TRUCK / BUS
Carrier Information: Carrier Source: GVWR, ICCMC, USDOT, MPSC
Driver's CDL Type, Endorsements: OH, OP, OT, OS, OX, CDL Exempt: Farm, Other, CDL Restrictions: 028, 029, 030, 035, 036
Interstate/Intrastate, Vehicle Type, Type & Axle Per Unit: First, Second, Third, Fourth, Cargo Body Type, Medical Card, Hazardous Material: Placard, Cargo Spill, ID #, Class #

OWNERS
Owner Information: YAN BAI, 5692 STRATFORD DR, WEST BLOOMFIELD, MI 48322

Person Advised of Damaged Traffic Control: Contact Name, Contact Date, Contact Time
Damaged Property: Owner & Phone, Public

UNIT / DRIVER	Unit Number	Unit Known	State	Driver License Number	Date of Birth (Age)	License Type	Endorsements	Sex	Total Occupants	Hazardous Action	
	02	Yes	MI	M255098889851	11/05/1963 (51)	<input checked="" type="radio"/> Operator <input type="radio"/> Chauffeur <input type="radio"/> Moped	<input type="radio"/> Cycle <input type="radio"/> Farm <input type="radio"/> Recreation	M	01	00 - None	
	Unit Type	Driver Information				Injury	Position	Restraint	Hospital		
	MV	BRADFORD WINSHIP MACKINNON 643 COVE VIEW DR WATERFORD, MI 48327				O	01	04	REFUSED		
	Driver Condition					Interlock	Ejected	Trapped	Airbag Deployed	Ambulance	
	<input checked="" type="radio"/> 1 <input type="radio"/> 2 <input type="radio"/> 3 <input type="radio"/> 4 <input type="radio"/> 5 <input type="radio"/> 6 <input type="radio"/> 7 <input type="radio"/> 8 <input type="radio"/> 9 <input type="radio"/> 99					No			No	REFUSED	
	Alcohol					Drugs			Citation Issued		
<input type="radio"/> Yes <input checked="" type="radio"/> No <input type="radio"/> Refused <input type="radio"/> Not offered					<input type="radio"/> Yes <input checked="" type="radio"/> No			<input type="radio"/> Hazardous <input type="radio"/> Other			
Test Type					Test Results			Test Results			
<input type="radio"/> Field <input type="radio"/> PBT <input type="radio"/> Breath <input checked="" type="radio"/> Blood <input type="radio"/> Urine					<input type="radio"/> Yes <input checked="" type="radio"/> No <input type="radio"/> Urine						
Vehicle Registration	State	Insurance / Policy #			Towed To/By			Special Vehicles	Private Trailer Type	Vehicle Defect	
CCH6282	MI	HOMEOWNERS			ROSS TOW			0			
VIN	Vehicle Description	Make	Model	Color	Year	Vehicle Type					
JN8AZ2KR0ET350272	NISSAN	CUBE		GRY	2014	Passenger Car					
Location of Greatest Damage	First Impact	Extent of Damage	Driveable	Vehicle Direction	Vehicle Use			Action Prior			
10	05	4	No	N	01 - Private			07 - Backing			
Sequence of Events				First	Second	Third	Fourth				
<input checked="" type="radio"/> 17 - Motor veh in transport				<input type="radio"/> 17 - Motor veh in transport							
<input checked="" type="radio"/> (● indicates MOST harmful event)											

PASSENGERS	Passenger Information				Date of Birth (Age)	Sex	Position	Restraint	Hospital	
	Passenger Information				Date of Birth (Age)	Sex	Position	Restraint	Hospital	
	Passenger Information				Date of Birth (Age)	Sex	Position	Restraint	Hospital	
Passenger Information				Date of Birth (Age)	Sex	Position	Restraint	Hospital		
Passenger Information				Date of Birth (Age)	Sex	Position	Restraint	Hospital		
Passenger Information				Date of Birth (Age)	Sex	Position	Restraint	Hospital		

TRUCK / BUS	Carrier Information				Carrier Source	GVWR	ICCMC	USDOT	MPSC	
					Driver's CDL Type	Endorsements	CDL Exempt	CDL Restrictions		
						<input type="radio"/> H <input type="radio"/> P <input type="radio"/> T <input type="radio"/> N <input type="radio"/> S <input type="radio"/> X	<input type="radio"/> Farm <input type="radio"/> Other	<input type="radio"/> 28 <input type="radio"/> 29 <input type="radio"/> 30 <input type="radio"/> 35 <input type="radio"/> 36		
Interstate/Intrastate	Vehicle Type	Type & Axle Per Unit		Cargo Body Type	Medical Card	Hazardous Material		ID #	Class #	
		First	Second	Third	Fourth		<input type="radio"/> Placard <input type="radio"/> Cargo Spill			

OWNERS	Owner Information				Owner Information			
	BRADFORD WINSHIP MACKINNON 643 COVE VIEW DR WATERFORD, MI 48327							

WITNESS	Witness Information				Witness Information			

Investigated at Scene	Reported Date (Time)	1st Investigator Name (Badge)		2nd Investigator Name (Badge)		Photos By	
Yes	11/11/2014 (17:10)	JONATHAN WALDEN (1150)				TPR MARTIN	

Narrative
 Vehicle 1, 2, 3, and 4 were traveling N/B M-10 in the right lane. Vehicles 1,2 and 3 were slowing on the roadway due to traffic. Vehicle 4 failed to stop in an assured clear distance and struck the rear of vehicle 3, which in turn struck vehicle 2, which in turn struck vehicle 1. Upon impact, vehicle 3 rolled over and became engulfed in flames. Vehicle 4 also caught on fire.

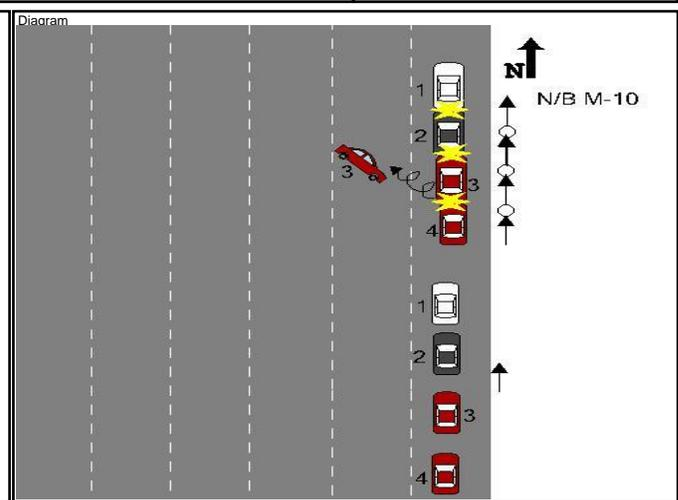

Authority: 1949 PA 300, Sec.257.622
Compliance: Required MSP UD-10E
Penalty: \$100 and/or 90 days (Rev 11/2006)

External # 0250964
Crash ID 9099115

Page 02 of 02
Incident # 212450314 File Class 93001

STATE OF MICHIGAN TRAFFIC CRASH REPORT

ORI: MI 6302100		Department Name MSP Metro North			Incident Disposition Open	
Crash Date 11/11/2014		Crash Time 16:38	No. of Units 04	Crash Type Rear End	Special Circumstances <input type="checkbox"/> School Bus <input checked="" type="checkbox"/> None <input type="checkbox"/> Hit and Run <input type="checkbox"/> Deer <input type="checkbox"/> Fleeing Police	Special Checks <input checked="" type="checkbox"/> Fatal <input type="checkbox"/> Non-Traffic Area <input type="checkbox"/> ORV/Snowmobile
County 63 - Oakland	Traffic Control None	Relation to Roadway On Road		Special Study	Weather Clear	Area 06 - All other freeway areas
City/Twsp 91 - Southfield	Construction Zone (if applicable) Type		Lane Closed	Activity	Light Dusk	Road Condition Dry
Total Lanes 06	Speed Limit 70	Posted Yes				

LOCATION	Prefix	Road Name M-10	Road Type FWY	Suffix	Divided Roadway N
	Distance 1,320 Feet S	Traffic Way 03 - Divided Hwy with barrier			Access Control 02 - Full access control
	Prefix	Intersecting Road TELEGRAPH	Road Type RD	Suffix	Divided Roadway

UNIT / DRIVER	Unit Number 03	Unit Known Yes	State MI	Driver License Number W300461560757	Date of Birth (Age) 10/01/1991 (23)	License Type <input checked="" type="checkbox"/> Operator <input type="checkbox"/> Chauffeur <input type="checkbox"/> Moped	Endorsements <input type="checkbox"/> Cycle <input type="checkbox"/> Farm <input type="checkbox"/> Recreation	Sex F	Total Occupants 01	Hazardous Action 00 - None	
	Unit Type MV	Driver Information KAYLA LUCILLE WHITE 2858 HORTON ST FERNDAL, MI 48220				Injury K	Position 01	Restraint 04	Hospital MORGUE		
	Driver Condition <input type="checkbox"/> 01 <input type="checkbox"/> 02 <input type="checkbox"/> 03 <input type="checkbox"/> 04 <input type="checkbox"/> 05 <input type="checkbox"/> 06 <input type="checkbox"/> 07 <input type="checkbox"/> 08 <input type="checkbox"/> 09 <input checked="" type="checkbox"/> 99				Interlock No	Ejected Yes	Trapped	Airbag Deployed Yes	Ambulance SOUTHFIELD FIRE DEPT/CITY OF		
	Alcohol <input type="checkbox"/> Yes <input checked="" type="checkbox"/> No Test Type <input type="checkbox"/> Field <input type="checkbox"/> PBT <input type="checkbox"/> Refused <input type="checkbox"/> Not offered <input type="checkbox"/> Breath <input type="checkbox"/> Blood <input type="checkbox"/> Urine				Test Results			Drugs <input type="checkbox"/> Yes <input checked="" type="checkbox"/> No Test Type <input type="checkbox"/> Blood <input type="checkbox"/> Urine	Citation Issued <input type="checkbox"/> Hazardous <input type="checkbox"/> Other		
	Vehicle Registration BSU1291	State MI	Insurance / Policy # STATEFARM		Towed To/By ROSS TOW			Special Vehicles 0	Private Trailer Type	Vehicle Defect	
	VIN 1J4GL48K13W675516	Vehicle Description JEEP	Make LIBERTY	Model LIBERTY	Color RED	Year 2003	Vehicle Type Passenger Car				
	Location of Greatest Damage 10	First Impact 05	Extent of Damage 7	Driveable No	Vehicle Direction N	Vehicle Use 01 - Private	Action Prior 08 - Slowing/stop on roadway				
	Sequence of Events (● indicates MOST harmful event)		First 17 - Motor veh in transport		Second 17 - Motor veh in transport		Third 06 - Overturn		Fourth ● 08 - Fire/explosion		

PASSENGERS	Passenger Information		Date of Birth (Age)	Sex	Position	Restraint	Hospital
	Injury		Airbag Deployed	Ejected	Trapped	Ambulance	
	Passenger Information		Date of Birth (Age)	Sex	Position	Restraint	Hospital
	Injury		Airbag Deployed	Ejected	Trapped	Ambulance	
	Passenger Information		Date of Birth (Age)	Sex	Position	Restraint	Hospital
	Injury		Airbag Deployed	Ejected	Trapped	Ambulance	
	Passenger Information		Date of Birth (Age)	Sex	Position	Restraint	Hospital
	Injury		Airbag Deployed	Ejected	Trapped	Ambulance	
	Passenger Information		Date of Birth (Age)	Sex	Position	Restraint	Hospital
	Injury		Airbag Deployed	Ejected	Trapped	Ambulance	
	Passenger Information		Date of Birth (Age)	Sex	Position	Restraint	Hospital
	Injury		Airbag Deployed	Ejected	Trapped	Ambulance	

TRUCK / BUS	Carrier Information		Carrier Source	GVWR	ICCMC	USDOT	MPSC
	Driver's CDL Type		Endorsements <input type="checkbox"/> H <input type="checkbox"/> P <input type="checkbox"/> T <input type="checkbox"/> O N <input type="checkbox"/> S <input type="checkbox"/> X		CDL Exempt <input type="checkbox"/> Farm <input type="checkbox"/> Other	CDL Restrictions <input type="checkbox"/> 028 <input type="checkbox"/> 029 <input type="checkbox"/> 030 <input type="checkbox"/> 035 <input type="checkbox"/> 036	
	Interstate/Intrastate	Vehicle Type	Type & Axle Per Unit First Second Third Fourth	Cargo Body Type	Medical Card	Hazardous Material <input type="checkbox"/> Placard <input type="checkbox"/> Cargo Spill	ID # Class #

OWNERS	Owner Information KAYLA LUCILLE WHITE 2858 HORTON ST FERNDAL, MI 48220	Owner Information
--------	---	-------------------

Person Advised of Damaged Traffic Control Contact Name: Contact Date: Contact Time:	Damaged Property Owner & Phone	Public
--	-----------------------------------	--------

UNIT / DRIVER	Unit Number	Unit Known	State	Driver License Number	Date of Birth (Age)	License Type	Endorsements	Sex	Total Occupants	Hazardous Action	
	04	Yes	MI	H300119723969	12/22/1944 (69)	● Operator ○ Chauffeur ○ Moped	○ Cycle ○ Farm ○ Recreation	M	01	12 - Unable to stop	
	Unit Type	Driver Information				Injury	Position	Restraint	Hospital		
	MV	CLARENCE QUENTIN HEATH 31080 HUNTLEY SQ E BEVERLY HILLS, MI 48025 (248) 792-7570				B	01	04	REFUSED		
	Driver Condition				Interlock	Ejected	Trapped	Airbag Deployed	Ambulance		
	● 1 ○ 2 ○ 3 ○ 4 ○ 5 ○ 6 ○ 7 ○ 8 ○ 9 ○ 99				No			Yes	SOUTHFIELD FIRE DEPT/CITY OF		
	Alcohol				Test Results		Drugs		Citation Issued		
	○ Yes ● No ○ Refused ○ Not offered						○ Yes ● No		○ Hazardous ○ Other		
	Test Type ○ Field ○ PBT ○ Breath ● Blood ○ Urine						Test Type ● Blood ○ Urine				
	Vehicle Registration	State	Insurance / Policy #		Towed To/By		Special Vehicles	Private Trailer Type	Vehicle Defect		
6LCX33	MI	TRUMBULL		ROSS TOW		0					
VIN	Vehicle Description	Make	Model	Color	Year	Vehicle Type					
1G6KY54992U178527	CADILLAC	STS		RED	2002	Passenger Car					
Location of Greatest Damage	First Impact	Extent of Damage	Driveable	Vehicle Direction	Vehicle Use		Action Prior				
01	01	4	No	N	01 - Private		01 - Going Straight Ahead				
Sequence of Events				First	Second	Third	Fourth				
● (● indicates MOST harmful event)				17 - Motor veh in transport	● 08 - Fire/explosion						

PASSENGERS	Passenger Information				Date of Birth (Age)	Sex	Position	Restraint	Hospital	
					Injury	Airbag Deployed	Ejected	Trapped	Ambulance	

TRUCK/BUS	Carrier Information				Carrier Source	GVWR	ICCMC	USDOT	MPSC	
					Driver's CDL Type	Endorsements	CDL Exempt	CDL Restrictions		
						○ H ○ P ○ T ○ N ○ S ○ X	○ Farm ○ Other	○ 28 ○ 29 ○ 30 ○ 35 ○ 36		
Interstate/Intrastate	Vehicle Type	Type & Axle Per Unit		Cargo Body Type		Medical Card	Hazardous Material		ID #	Class #
		First	Second	Third	Fourth		○ Placard ○ Cargo Spill			

OWNERS	Owner Information				Owner Information			
	CLARENCE QUENTIN HEATH 31080 HUNTLEY SQ E BEVERLY HILLS, MI 48025							

WITNESS	Witness Information				Witness Information			

Investigated at Scene	Reported Date (Time)	1st Investigator Name (Badge)		2nd Investigator Name (Badge)		Photos By

Narrative	Diagram

ATTACHMENT 6

Mr. Clarence M. Ditlow, Director
Center for Auto Safety
Suite 330
1825 Connecticut Ave, NW
Washington, DC 20009-5708
(202) 328-7700

12 February 2015

Subject 1: Criminal Investigation of DOT, NHTSA and FCA (Re: Closure of EA12-005)
Subject 2: The Manslaughter of Ms. Kayla Lucille White on 11 November 2014

Eleven Pages

Oakland County Michigan, Office of the Medical Examiner, Autopsy Report concerning the death of Ms. Kayla Lucille White on 11 November 2014.



L. BROOKS PATTERSON, OAKLAND COUNTY EXECUTIVE

COUNTY MICHIGAN
OFFICE OF THE MEDICAL EXAMINER

PUBLIC SERVICES
R. Gerds, Administrator

L. J. Dragovic, M.D., Chief Medical Examiner
K. Virani, M.D., Deputy Chief Medical Examiner
B. Pacris, M.D., Deputy Medical Examiner
R. Ortiz-Reyes, M.D., Deputy Medical Examiner
C. Loewe, M.D., Deputy Medical Examiner

January 20, 2015

DDM Consulting
ATTN: Paul Sheridan
22357 Columbia St.
Dearborn, MI 48124-3431

Re: Kayla White
O.C.M.E. # 14-5786

Dear Mr. Sheridan:

We received your written request for the autopsy report regarding Kayla White, who died on November 11, 2014, in Southfield, Michigan. Once we receive payment from you, the report will be mailed.

CHARGES: \$20.67 (1 Hour Clerical Time)
00.30 (10 pages)
\$20.97 GRAND TOTAL

Please make your check payable to the Oakland County Medical Examiner and mail to:
1200 North Telegraph Road, Building 28 East, Pontiac, MI 48341-0438.
The Federal I.D. Number for this office is 38-6004876.

Sincerely,

Oakland County Medical Examiner's Office

/la



COUNTY MICHIGAN
OFFICE OF THE MEDICAL EXAMINER

PUBLIC SERVICES
R. Gerds, Administrator

L. J. Dragovic, M.D., Chief Medical Examiner
K. Virani, M.D., Deputy Chief Medical Examiner
B. Pacris, M.D., Deputy Medical Examiner
R. Ortiz-Reyes, M.D., Deputy Medical Examiner
C. Loewe, M.D., Deputy Medical Examiner

AUTOPSY PROTOCOL

**NAME OF DECEASED: KAYLA LUCILLE WHITE
(UNKNOWN FEMALE #14-11)**

CASE NUMBER: 14-5786

GENDER: Female AGE: 23 Years RACE: White

DATE OF DEATH: November 11, 2014 TIME: Approx. 4:38 p.m.

PLACE OF DEATH: Vehicle/Road

DATE PRONOUNCED: November 11, 2014 TIME: 5:10 p.m.

PLACE PRONOUNCED: Southfield

DATE OF AUTOPSY: November 12, 2014 TIME: 8:50 a.m.

CAUSE OF DEATH: THERMAL INJURY and SMOKE INHALATION

MANNER OF DEATH: ACCIDENT

EXTERNAL EXAMINATION

The body is that of a severely burned white female, 60", 116 pounds with abdominal girth of 36", normally developed, normally nourished and appearing consistent with the stated age of 23 years. Small burned pieces of a shirt, pants and underwear are present on the body.

The body is cold. Rigor mortis and livor mortis cannot be determined due to thermal injury.

The scalp hair is brown and severely singed. Thermal injuries are present on the head and face. The eye color cannot be determined due to thermal injury. The corneae are severely cloudy. The sclerae are white. There are no conjunctival petechiae or hemorrhage. Natural teeth are present. Soot is present in the nostrils and mouth. The ears show thermal injury. Thermal injury is present on the neck, chest and abdomen. The abdomen is protuberant. Minimal thermal injury is present on the genitalia and groin. The extremities show severe thermal injury. The back also has severe thermal injury.

SCARS: None visible.

TATTOOS: A partially burned tattoo is present on the left side of the groin.

EVIDENCE OF THERAPY: None.

EVIDENCE OF INJURY: Second and third degree thermal injury is present on the body surface occupying the head, face, neck, chest, abdomen, extremities and back. It covers 90% of the body surface. The maximum thermal injury is present on the lower extremities with exposure of the muscles and deep soft tissue.

INTERNAL EXAMINATION

BODY CAVITIES: The body cavities are entered in the usual manner. All body cavities are free of excess or abnormal fluid accumulation. The serosal surfaces are smooth. There is no evidence of blunt force or penetrating injury to the thoraco-abdominal region.

HEAD AND BRAIN: The brain weighs 1203 grams. The scalp is unremarkable. The skull is intact. The dura is unremarkable. The venous sinuses are unremarkable. There is no evidence of epidural, subdural or subarachnoid hemorrhage. The leptomeninges are thin and transparent. The cerebrospinal fluid is clear. The vessels at the base of the brain are unremarkable. The cerebral hemispheres are symmetrical. Serial sectioning of the brain does not reveal any focal abnormality. The surface of the brain is unremarkable. The cerebellum and brain stem are unremarkable.

NECK ORGANS: The soft tissues and muscles of the neck are unremarkable. The laryngeal cartilages are unremarkable. The hyoid bone and cervical vertebrae are intact. Dense soot is present on the surface of the larynx and upper trachea. The pharynx is unremarkable.

CARDIOVASCULAR SYSTEM: The heart weighs 259 grams. The myocardium has a homogeneous brown appearance without myocardial fibrosis or focal myocardial infarction. The left ventricle measures 1.4 cm and the right ventricle measures 0.2 cm in thickness. The endocardium is smooth. The cardiac valves are unremarkable. The cardiac chambers are within normal limits. The tricuspid valve is 12 cm, pulmonic 6.5 cm, mitral 8.5 cm, and aortic 5.5 cm circumference. The coronary arteries are normally distributed with right dominant circulation. The aorta, its major branches and major veins are unremarkable.

RESPIRATORY SYSTEM: The right lung weighs 366 grams and the left lung weighs 358 grams. Soot is present on the mucosa of the trachea and bronchi. Mild pulmonary edema and congestion are present. The pleural surfaces are smooth and glistening. The airways are clear. The pulmonary arteries are unremarkable.

DIGESTIVE SYSTEM: The tongue and esophagus are unremarkable. The stomach contains about 500 grams of digested semi-solid food. The small and large intestines are unremarkable. The appendix is present. The pancreas is unremarkable.

LIVER: The liver weighs 1788 grams. The surface is smooth and glistening. The parenchyma has a homogeneous brown appearance without fatty degeneration or focal abnormality. The gallbladder is absent.

SPLEEN: The spleen weighs 142 grams. The capsule is intact. The parenchyma is unremarkable.

THYMUS GLAND: The thymus weighs 13 grams. The capsule is intact. The parenchyma is unremarkable.

GENITO-URINARY SYSTEM: The right kidney weighs 113 grams and the left kidney weighs 122 grams. The capsules are easy to separate. The subcapsular surfaces are smooth. The parenchyma is unremarkable. Cortico-medullary demarcation is well-distinct. The calyces and pelves are unremarkable. The ureters are patent. The urinary bladder contains about 2 cc of turbid urine. The mucosa is unremarkable. The uterus is gravid

GENITO-URINARY SYSTEM (con't): containing a male fetus. The fetus weighs 1955 grams and measures 43 cm in length. The head circumference is 30.5 cm. There are no identifiable abnormalities or injuries in the uterus, placenta or the fetus. The fallopian tubes and ovaries are unremarkable.

LYMPH NODES: Small lymph nodes are present in the hilum of both lungs and mediastinum measuring up to 0.5 cm.

ENDOCRINE SYSTEM: The pituitary, thyroid and adrenals are unremarkable.

MUSCULOSKELETAL SYSTEM: Thermal injuries are present in the skeletal muscles. The bony skeleton is intact.

AUTOPSY FINDINGS:

- I. Thermal Injury and Smoke Inhalation with
 - A. 90% second and third degree thermal injury on the body surface
 - B. Presence of soot on the mucosa of the larynx, trachea and bronchi
 - C. 10% blood carbon monoxide levels
 - D. Pulmonary mild edema and congestion

OPINION: This 23-year-old white female, Kayla White, died of thermal injuries and smoke inhalation. Careful examination did not reveal any identifiable physical injuries in the internal organs. The manner of death is accident.

Kanu Virani, M.D. 11-24-14
KANU VIRANI, M.D.
DEPUTY CHIEF MEDICAL EXAMINER

Oakland County Medical Examiner

Kayla White
NAME: Female # 14-11 Unknown

CASE #: 14-05786

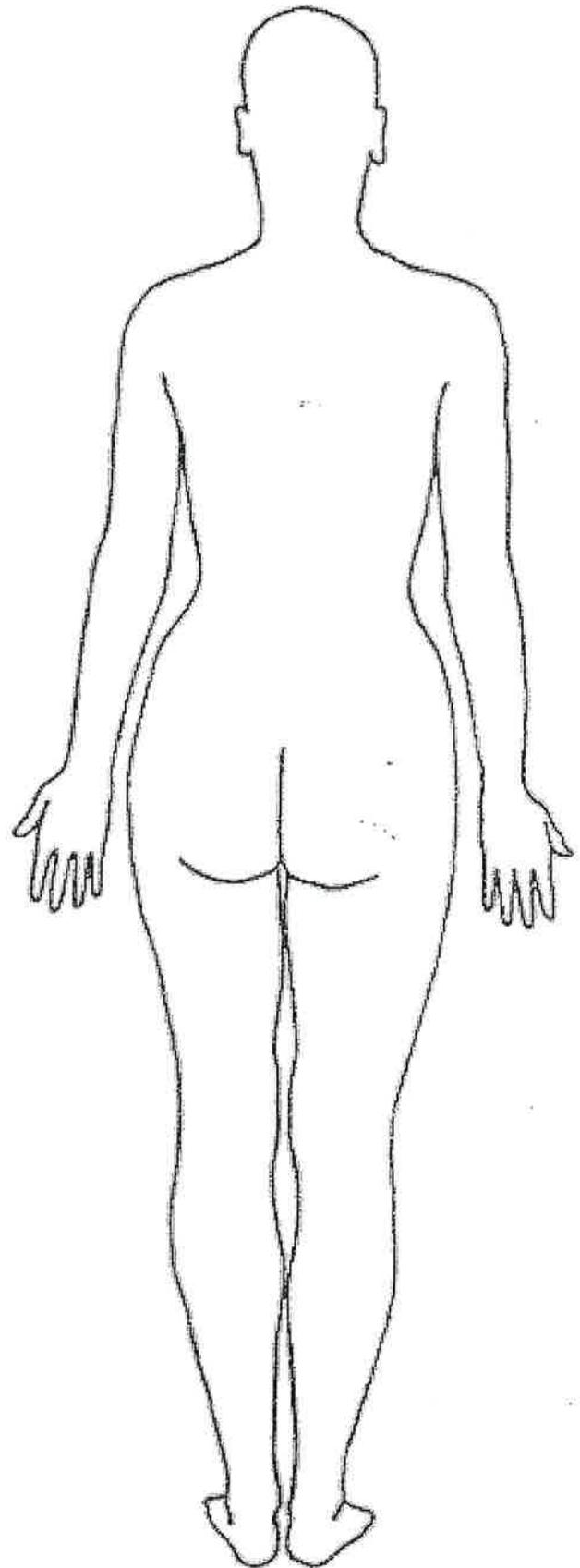
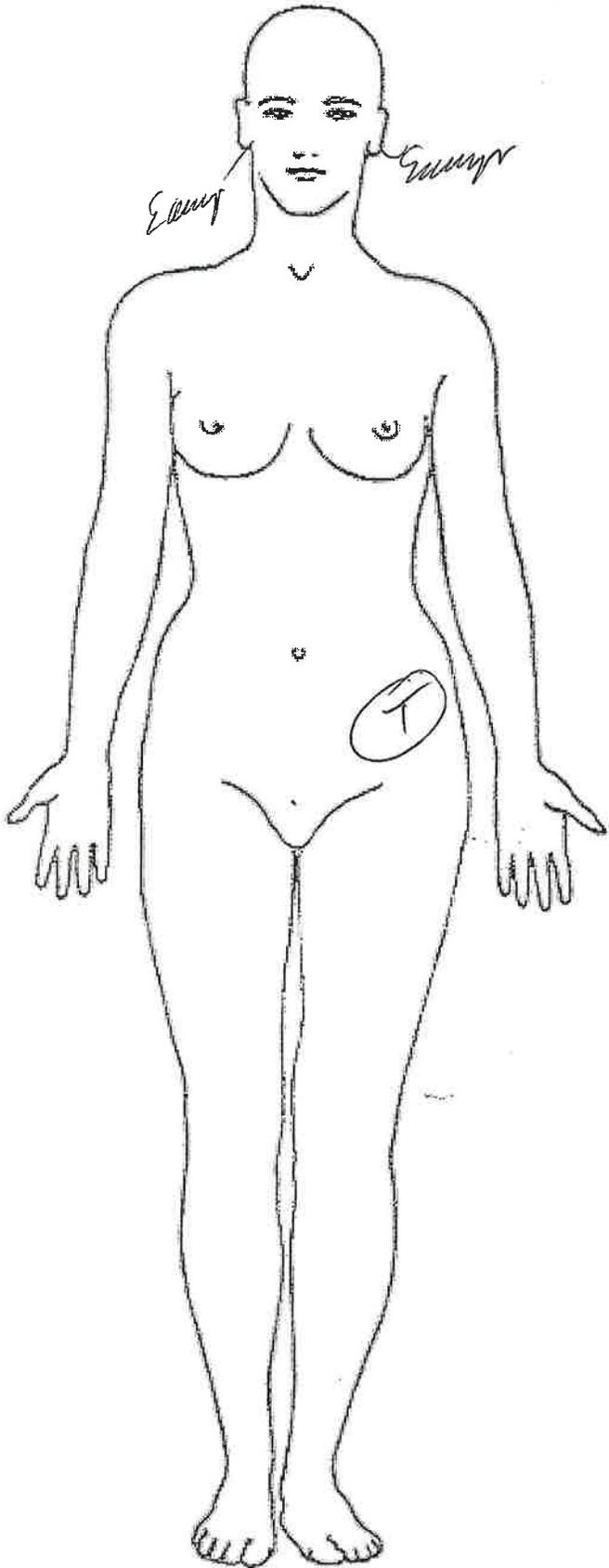



L. BROOKS PATTERSON, OAKLAND COUNTY EXECUTIVE

COUNTY MICHIGAN
OFFICE OF THE MEDICAL EXAMINER

PUBLIC SERVICES
R. Gerds, Administrator

L. J. Dragovic, M.D., Chief Medical Examiner
K. Virani, M.D., Deputy Chief Medical Examiner
B. Pacris, M.D., Deputy Medical Examiner
R. Ortiz-Reyes, M.D., Deputy Medical Examiner
C. Loewe, M.D., Deputy Medical Examiner

TOXICOLOGY REPORT

NAME: KAYLA WHITE
CASE # 14-5786

VOLATILE SCREEN

INCLUDES: ACETONE, ETHYL ALCOHOL, ISOPROPYL ALCOHOL, METHYL ALCOHOL

REPORT: FEMORAL BLOOD – None detected

VITREOUS – None detected

HEART BLOOD DRUG SCREEN*

INCLUDES: ACETAMINOPHEN, AMPHETAMINES/METHAMPHETAMINES, BARBITURATES, BENZODIAZEPINES, CANNABINOIDS, CARISOPRODOL, COCAINE/COCAINE METABOLITES, FENTANYL, FLUOXETINE, METHADONE, METHYLPHENIDATE, OPIATES, SALICYLATES, TRICYCLIC ANTIDEPRESSANTS

REPORT: Cannabinoids detected

SERUM DRUG SCREEN*

INCLUDES: ANTICONVULSANTS, TRICYCLIC ANTIDEPRESSANTS

REPORT: Specimen not suitable for toxicological analysis

URINE DRUG SCREEN*

INCLUDES: AMPHETAMINES, BARBITURATES, BENZODIAZEPINES, CANNABINOIDS, COCAINE/COCAINE METABOLITES, METHADONE, OPIATES, PHENCYCLIDINE

REPORT: None detected

FEMORAL BLOOD CARBON MONOXIDE

REPORT: 19% Carboxyhemoglobin Saturation

DATE: 01/7/2015

Denice M. Teem
DENICE M. TEEM, BS
CERTIFYING SCIENTIST, FOR NMS LABS

ds

*This is an unconfirmed screen. Confirmation by a more definitive technique such as GC/MS is recommended.



NMS Labs

CONFIDENTIAL

3701 Welsh Road, PO Box 433A, Willow Grove, PA 19090-0437
Phone: (215) 657-4900 Fax: (215) 657-2972
e-mail: nms@nmslabs.com

Robert A. Middleberg, PhD, F-ABFT, DABCC-TC, Laboratory Director

Toxicology Report

Report Issued 12/04/2014 10:00

Patient Name WHITE Kayla
Patient ID 14-5786
Chain 28829
Age Not Given **DOB** Not Given
Gender Female
Workorder 14299614

To: 10062
Oakland County Medical Examiner
Attn: Toxicology
1200 N Telegraph Rd-Bldg 28 E
Pontiac, MI 48341

Page 1 of 3

Positive Findings:

<u>Compound</u>	<u>Result</u>	<u>Units</u>	<u>Matrix Source</u>
Carboxyhemoglobin	21	%Saturation	001 - Femoral Blood
Delta-9 THC	1.5	ng/mL	001 - Femoral Blood

See Detailed Findings section for additional information

Testing Requested:

<u>Analysis Code</u>	<u>Description</u>
1009B	Carbon Monoxide Exposure, Blood
8061B	Postmortem Toxicology - Basic w/o Alcohol, Blood (Forensic)

Specimens Received:

<u>ID</u>	<u>Tube/Container</u>	<u>Volume/ Mass</u>	<u>Collection Date/Time</u>	<u>Matrix Source</u>	<u>Miscellaneous Information</u>
001	Lavender Vial	6 mL	11/12/2014	Femoral Blood	

All sample volumes/weights are approximations.
Specimens received on 11/21/2014.



CONFIDENTIAL

Workorder 14299614
Chain 28829
Patient ID 14-5786

Page 2 of 3

Detailed Findings:

Analysis and Comments	Result	Units	Rpt. Limit	Specimen Source	Analysis By
Carboxyhemoglobin	21	%Saturation	2	001 - Femoral Blood	GC/MS
Delta-9 THC	1.5	ng/mL	1.0	001 - Femoral Blood	GC-GC-GC/MS

Other than the above findings, examination of the specimen(s) submitted did not reveal any positive findings of toxicological significance by procedures outlined in the accompanying Analysis Summary.

Reference Comments:

1. Carboxyhemoglobin (COHb) - Femoral Blood:

Hemoglobin is a protein found in red blood cells that is responsible for the oxygen carrying capacity of blood. In normal conditions, hemoglobin receives oxygen via blood circulation through the lungs and delivers the oxygen to tissues and organs throughout the body. In situations where the inspired air is high in carbon monoxide concentration, the hemoglobin then binds the carbon monoxide in place of oxygen. This leads to a functional deficiency in oxygen delivery to the organs and tissues of the body.

Measurement of carbon monoxide hemoglobin saturation gives an indication of the carbon monoxide concentration in the inspired air and its possible sequelae. Normal endogenous carboxyhemoglobin levels are generally up to 4% in non-smokers and up to 8% in smokers (although it may be higher); toxic symptoms may be noted at levels >10%. Concentrations over 10% saturation have been reported to produce adverse effects, e.g., headache and nausea. Deaths from carbon monoxide, in the absence of resuscitative measures, generally have associated carboxyhemoglobin levels >40%. However, individuals with a compromised cardiovascular system are at a potentially greater risk of toxic effects at much lower carbon monoxide hemoglobin saturation values.

2. Delta-9 THC (Active Ingredient of Marijuana) - Femoral Blood:

Marijuana is a DEA Schedule I hallucinogen. Pharmacologically, it has depressant and reality distorting effects. Collectively, the chemical compounds that comprise marijuana are known as Cannabinoids.

Delta-9-THC is the principle psychoactive ingredient of marijuana/hashish. It rapidly leaves the blood, even during smoking, falling to below detectable levels within several hours. THC concentrations in blood are usually about one-half that of serum/plasma concentrations. The active metabolite, 11-hydroxy-THC, may also fall below detectable levels shortly after inhalation. Delta-9-carboxy-THC (THCC) is the inactive metabolite of THC with peak concentrations attained 32 to 240 minutes after smoking and may be detected for up to one day or more in blood. Both delta-9-THC and THCC may be present substantially longer in chronic users.

Reported usual peak THC concentrations in serum after smoking 1.75% or 3.55% THC marijuana cigarettes are 50 - 270 ng/mL after beginning of smoking, decreasing to less than 5 ng/mL by 2 hrs. Corresponding delta-9-carboxy-THC concentrations range from 10 - 101 ng/mL about 32 to 240 minutes after the beginning of smoking and decline slowly. Passive inhalation of marijuana smoke has been reported to produce blood THC concentrations up to 2 ng/mL. Delta-9-carboxy THC concentrations in blood may not be present following passive inhalation of marijuana smoke.

Unless alternate arrangements are made by you, the remainder of the submitted specimens will be discarded one (1) year from the date of this report; and generated data will be discarded five (5) years from the date the analyses were performed.

Workorder 14299614 was electronically signed on 12/04/2014 09:57 by:

Daniel S. Isenschmid, Ph.D., F-ABFT
Forensic Toxicologist



CONFIDENTIAL

Workorder 14299614
Chain 28829
Patient ID 14-5786

Page 3 of 3

Analysis Summary and Reporting Limits:

All of the following tests were performed for this case. For each test, the compounds listed were included in the scope. The Reporting Limit listed for each compound represents the lowest concentration of the compound that will be reported as being positive. If the compound is listed as None Detected, it is not present above the Reporting Limit. Please refer to the Positive Findings section of the report for those compounds that were identified as being present.

Acode 1009B - Carbon Monoxide Exposure, Blood - Femoral Blood

-Analysis by Gas Chromatography/Mass Spectrometry (GC/MS) for:

<u>Compound</u>	<u>Rpt. Limit</u>	<u>Compound</u>	<u>Rpt. Limit</u>
Carboxyhemoglobin	2 %Saturation		

Acode 50013B - Cannabinoids Confirmation, Blood (Forensic) - Femoral Blood

-Analysis by Multi-dimensional Gas Chromatography/Mass Spectrometry (GC-GC-GC/MS) for:

<u>Compound</u>	<u>Rpt. Limit</u>	<u>Compound</u>	<u>Rpt. Limit</u>
11-Hydroxy Delta-9 THC	5.0 ng/mL	Delta-9 THC	1.0 ng/mL
Delta-9 Carboxy THC	5.0 ng/mL		

Acode 8061B - Postmortem Toxicology - Basic w/o Alcohol, Blood (Forensic) - Femoral Blood

-Analysis by Enzyme-Linked Immunosorbent Assay (ELISA) for:

<u>Compound</u>	<u>Rpt. Limit</u>	<u>Compound</u>	<u>Rpt. Limit</u>
Amphetamines	20 ng/mL	Methadone	25 ng/mL
Barbiturates	0.040 mcg/mL	Methamphetamine	20 ng/mL
Benzodiazepines	100 ng/mL	Opiates	20 ng/mL
Cannabinoids	10 ng/mL	Oxycodone	10 ng/mL
Cocaine / Metabolites	20 ng/mL	Phencyclidine	10 ng/mL
Fentanyl	0.50 ng/mL		

-Analysis by Enzyme-Linked Immunosorbent Assay (ELISA) for:

<u>Compound</u>	<u>Rpt. Limit</u>	<u>Compound</u>	<u>Rpt. Limit</u>
Buprenorphine / Metabolite	0.50 ng/mL		

END OF DOCUMENT

Mr. Clarence M. Ditlow, Director
Center for Auto Safety
Suite 330
1825 Connecticut Ave, NW
Washington, DC 20009-5708
(202) 328-7700

12 February 2015

Subject 1: Criminal Investigation of DOT, NHTSA and FCA (Re: Closure of EA12-005)

Subject 2: The Manslaughter of Ms. Kayla Lucille White on 11 November 2014

ATTACHMENT 4

29 April 2015

Attorney General Kamala D. Harris
Office of the Attorney General
1300 "I" Street
Sacramento, CA 95814-2919
916-445-9555

Subject: Criminal Investigation of those Responsible for Severe Injury to the Sanchez Brothers
Ref: Conspiratorial Closure of NHTSA EA12-005: Jeep Fuel System Crashworthiness Defect

Forty-Seven Pages

Letter sent to the CAS on August 20, 2014. Called for a criminal investigation of these matters eight months prior to the jury “percentage of fault” determination in Walden. Note that the Sanchez Brothers are discussed on page 1 and atop page 14.

To: Mr. Clarence Ditlow, Director
Center for Auto Safety - Suite 330
1825 Connecticut Ave, NW
Washington, DC 20009-5708
202-328-7700

Date: 20 August 2014

VIA FEDEX AIRBILL 8007 – 9341 - 6064

From: Paul V. Sheridan
DDM Consulting
22357 Columbia Street
Dearborn, MI 48124-3431
313-277-5095 / pvs6@cornell.edu

Subject: Proposal for Criminal Investigation of Chrysler, and Senatorial review of NHTSA EA12-005 *

Reference 1: Senator Claire McCaskill, Senate Subcommittee on Consumer Protection and Product Safety

Reference 2: Criminal Manslaughter Indictments Involving Fire-Death in EA12-005 Jeep (Filed 9 July 2014)



Courtesy Copy List

Senator Claire McCaskill
506 Hart Senate Building
Washington, D.C. 20510
202-224-6154

Senator Richard Blumenthal
724 Hart Senate Building
Washington, DC 20510
202-224-2823

Mr. Kenneth Feinberg
Feinberg Rozen, LLP - Suite 390
1455 Pennsylvania Ave, NW
Washington, DC 20004-1008
202-371-1110

Ms. Inês Murphy, Esq.
SilvaMurphy LLC
Suite 520
105 East Jefferson Blvd.
South Bend, IN 46601
574-292-0640

Mr. Courtney E. Morgan, Jr.
Morgan & Meyers, PLLC
Suite 320
3200 Greenfield Road
Dearborn, MI 48120
313-961-0130

Mr. Fernando Chavez
Chavez Law Group
1300 West Beverly Blvd.
Montebello, CA 90640
855-424-2839

Secretary Anthony R. Foxx
US Department of Transportation
1200 New Jersey Ave, SE
Washington, DC 20590
202-366-4000

Mr. David J. Friedman
NHTSA Headquarters
West Building
1200 New Jersey Avenue, SE
Washington, DC 20590

Mr. Scott G. Kunselman
Vehicle Safety/Regulatory Compliance
Chrysler Group LLC
1000 Chrysler Drive
Auburn Hills MI 48321-8004
248-576-5741

* This document, with active hyperlinks (please see red font Endnotes) is available at :

<http://pvsheridan.com/Sheridan2Ditlow-3-20Aug2014.pdf>

DDM Consulting
22357 Columbia Street
Dearborn, MI 48124-3431
313-277-5095 / pvs6@cornell.edu

20 August 2014

VIA FEDEX AIRBILL 8007 – 9341 - 6064

Mr. Clarence Ditlow, Director
Center for Auto Safety - Suite 330
1825 Connecticut Ave, NW
Washington, DC 20009-5708

Subject: Proposal for Criminal Investigation of Chrysler, and Senatorial review of NHTSA EA12-005
Reference 1: Senator Claire McCaskill, Senate Subcommittee on Consumer Protection and Product Safety
Reference 2: Criminal Manslaughter Indictments Involving Fire-Death in EA12-005 Jeep (Filed 9 July 2014)

Dear Mr. Ditlow:

According to the officials pictured (former Secretary of Transportation Raymond LaHood, former National Highway Traffic Safety Administration (NHTSA) Administrator David Strickland, and Fiat Chrysler Automobiles (FCA) Chairman Sergio Marchionne), the ZJ-Body Jeep Grand Cherokee pictured at left below contains no safety defects ⁱ :



These officials also assert that occupants of the vehicle in the middle are not at risk when in accident proximity to the four Jeep engineered platforms (XJ, ZJ, WJ, and KJ-Body) of the NHTSA EA12-005 defect investigation. ⁱⁱ This posturing is not merely a matter of misstatements and/or incompetence; these are matters that indicate a more urgent legal issue.

NHTSA and Chrysler Placed On-Notice: FMVSS Process Rejected as Basis of Safety Leadership

Relating to the conflagration above, LaHood, Strickland, Marchionne and others have parroted the following diversion:

“The Jeep (fuel system) meets or exceeds all federal safety standards and has an outstanding safety record.”

In December 1992 I was selected by Chrysler management to chair their Safety Leadership Team (SLT).ⁱⁱⁱ The central role of the SLT is specified by its central descriptor, “leadership.” Immediately and implicitly the SLT recognized the following ongoing automotive safety facts and related operatives:

1. The regulatory process and resulting FMVSS did not protect the public with respect to the “real world.”
2. Executive management and executive engineering management at Chrysler were aware of #1.
3. The FMVSS process was not only incompetent but most likely corrupt/corrupted.
4. In the context of #3 and others, despite FMVSS compliance Chrysler and most competitors (which also had a compliance only posture) produced products that contained blatant safety defects.
5. Despite FMVSS compliance, Chrysler and most competitors could not and did not prevail against allegations of safety defects by the plaintiff’s bar.
6. Rather than FMVSS being viewed as a minimum or merely a starting point, FMVSS was touted as “stringent” in Chrysler PR rhetoric. Likewise, Chrysler defense lawyers routinely have used FMVSS compliance as a legal “strawman.” With respect to many FMVSS, this posturing was considered by the SLT as not only dangerous to our customers, but demonstrably fraudulent.
7. The central mandate of the SLT could not be fulfilled by being complicit with the FMVSS process.
8. Given #6 and #7, the SLT would view FMVSS as merely a starting point for its mandate, a point common to the entire automotive industry. Instead the SLT would protect its customers by complying with the real world which would elevate Chrysler into true leadership, and therefore genuine superiority versus its competitors.

On March 16, 1993 I played for the SLT the February 1992 CBS News *60 Minutes* report on the injuries and deaths caused by automotive seat back failures.^{iv} As is well-known to Chrysler, this was the second time that I had played this report for executive review. My purpose included demonstration of the following safety facts and related operatives:

- A. The existing regulatory process and resulting FMVSS-207 seat back standard did not protect the public in the “real world.”
- B. Despite compliance with FMVSS-207, Chrysler and most competitors produced defective seat backs, and were therefore responsible for the proximate cause of injury and death.
- C. Despite compliance with FMVSS-207, Chrysler and most competitors did not prevail against legal allegations of defective seats by the plaintiffs. These lawsuits, which were extensively detailed by *60 Minutes*, involved Chrysler and its major competitors.
- D. Chrysler and its competitors did not offer an on-camera interview with *60 Minutes*.

As noted by the SLT, Items 1 thru 8 and Items A thru D were not only an embarrassment but these were in stark contrast to the interview and operative offered by a true leader in automotive safety.

NHTSA and Chrysler Placed On-Notice: FMVSS Process Rejected as Basis of Safety Leadership - cont.

In stark contrast to Items 1 thru 8 and A thru D above, Mercedes-Benz safety engineer Dr. Tom Bologna offered the following operative to, not only *60 Minutes*, but to NHTSA, the industry, the SLT and therefore Chrysler:



Dr. Bologna: *Mercedes-Benz tests with the weight of a person in the seat.*

60 Minutes: *Why?*

Dr. Bologna: *To simulate what is going on in the **real world**.* ^v

(MEMO: TO THIS DAY, NHTSA, UNDER FMVSS-207, *STILL* DOES NOT CONSIDER THE REAL WORLD POSSIBILITY OF A PERSON BEING IN THE SEAT AS A BASIS FOR SPECIFYING ITS SEAT SAFETY STANDARD.) ^{vi}

In many depositions and trials I have testified regarding the meeting minutes which documented the March 16, 1993 viewing by the Safety Leadership Team (SLT) of this *60 Minutes* report. In essence, these SLT meeting minutes distributed Items 1 thru 8 and A thru D throughout Chrysler. I was reprimanded and issued a 'retrieve & destroy' ^{vii} directive by Chrysler executive management, including but not limited to the "Father of the Jeep," Mr. Francois Castaing.

The SLT also noted content in the *60 Minutes* report that is directly relevant to the current subject. NHTSA investigation EA12-005 is reviewing issues related to locating the fuel tank behind the rear axle, below the bumper and without adequate shielding. Note that the fuel system defect of the Ford Pinto, and the NHTSA crash tests that prove that status, are prominently presented. The lack of fuel system crashworthiness of the General Motors W-Body is also presented by this February 1992 *60 Minutes* report.

NHTSA and Chrysler Placed On-Notice: FMVSS Process Rejected as Basis of Safety Leadership - SUMMARY

Both NHTSA and Chrysler were placed on-notice regarding the general inadequacy of the FMVSS process. The on-notice status is confirmed by, but not limited to the following events:

- In March 1993 I put Chrysler executive management on-notice, by the SLT meeting minutes, that merely complying with FMVSS standards did not and could not protect our customers. From that point forward all rhetoric, from public relations to defense bar posturing to industry responses in NHTSA defect investigations, are essentially illegitimate. The court records spanning the last twenty-one years prove this essence.
- In February 1992, the content of the CBS News *60 Minutes* report placed NHTSA and potentially the entire automotive industry on-notice regarding Items 1 thru 8, and A thru D above.
- On 11 April 1995 I personally placed NHTSA on-notice, during an interview with its officials regarding Items 1 thru 8 and A thru D above. ^{viii}

I reviewed FMVSS-207 history because it is representative of the flawed FMVSS process. ^{ix} Relating to the current subject, the standard that could not and did not protect the public is FMVSS-301. Its lack of *real world* value is not esoteric, it is quite simple. It is not subtle, it is blatant. It is not a new issue; the failure of FMVSS-301 is decades old. That mere compliance with FMVSS-301 is indefensible is well-known, but public awareness of this deficiency has been purposely obscured by a routine practice of litigation wherein Chrysler settlements demand "confidentiality agreements."

NHTSA and Chrysler Placed On-Notice: Specific Safety Issues Review Relating to EA12-005

SLT rejection of the FMVSS process as a basis of safety leadership remains valid. This is partially confirmed by existence of the (blatant) fuel system defects contained in the EA12-005 Jeeps. This history spans decades:

- a. In August 1978, in preparation for meetings at high levels of Chrysler and Mitsubishi Motor Corporation, a memo was prepared to summarize the fuel system crashworthiness of their cars, trucks and SUVs. The “Baker memo,” like the *60 Minutes* report, highlighted the Ford Pinto fuel system defects.^x Mr. Baker specifically warned of the dangers of locating a fuel tank similar to the Ford Pinto: In the rearmost location, while not offering direct impact protection and no shielding from road projectiles. Incredibly, as I have said publically, the four Jeep types that were under the EA12-005 investigation (XJ, ZJ, WJ, and KJ-Body) are actually worse than the Ford Pinto.
- b. During 1987-1991 I was an Engineering Programs Manager for Jeep and Dodge Truck Engineering (JTE).^{xi} The Vice President of JTE was the ‘Father of the Jeep,’ Mr. Francois Castaing.^{xii} I was assigned to the N-Body, which was marketed as the Dodge Dakota pick-up truck. The N-Body fuel system had a structural architecture very similar to the current WK-Body; marketed in 2005 as an all-new Jeep Grand Cherokee. The WK-Body was primarily engineered by Daimler-Benz, parent company of Mercedes-Benz (ala Dr. Tom Bologna of *60 Minutes*). The German components and design of the WK-Body was touted in the Jeep advertising.^{xiii}
- c. In June 2011, in the fire-death litigation of Mrs. Susan Kline, Mr. Castaing admitted that I had recommended an alternative design for the original Jeep Grand Cherokee. I had recommended that the 1993 Jeep Grand Cherokee not be based on the ZJ-Body, but should be based on the N-Body platform. Castaing admitted that he and others had rejected my recommendation. The Baker memo was a crucial part of my N-Body recommendation. As later adopted in the 2005 WK-Body, the N-Body did not deploy the unshielded rearmost fuel tank location.^{xiv}

Castaing’s rejection of the N-Body for the 1993 Jeep Grand Cherokee resulted a design derived from the old XJ-Body. Originally coded XJC-Body, this design was developed in the late 1970s during the Ford Pinto and the Baker memo.

When deposed in 1995 about his designs, and **real world** phrase crashworthiness, the “Father of the Jeep” stated:^{xv}

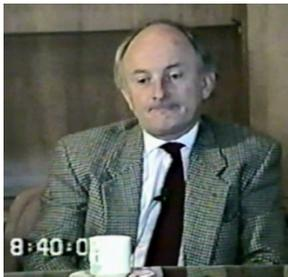

Attorney: **What does the term crashworthiness mean in terms of design of a product?**

Castaing: *I don’t know. Tell me.*

Attorney: **You don’t know the phrase?!**

Castaing: *No.*

Attorney: **Well, let me make sure I’m clear on this. As the chief engineer of the company, are you at all familiar with the use of the phrase crashworthiness by the engineers of the company?**

Castaing: *Crashworthiness is so vague that you have to tell me what you intend by that.*

In October 2009, prompted in-part by the fire-death of Mrs. Susan Kline, the Center for Auto Safety (CAS) petitioned NHTSA regarding the lack of fuel system crashworthiness of the ZJ-Body Jeep Grand Cherokee (DP09-005):

- i. In May 2010, at the Russell Senate Office Building, I spoke to NHTSA Administrator David Strickland. I reviewed some of the above, highlighted by my possession of the Baker memo. Mr. Strickland demanded to receive the latter, which occurred in June 2010.
- ii. In August 2010, NHTSA opened an investigation of the ZJ-Body fuel system crashworthiness (PE10-031).
- iii. In January 2011 CAS Founder Ralph Nader spoke to Fiat representatives in Milan, Italy regarding PE10-031, and issued a press release aimed at Chrysler Chairman Sergio Marchionne. While emphasizing the horrific fire-death of Mrs. Susan Kline, and rejecting the notion that “*crashworthiness is so vague*,” Nader characterized the Jeeps as, “a modern day Pinto for soccer moms.”^{xvi}
- iv. In June 2012 PE10-031 was upgraded to EA12-005, which added the XJ, WJ, and KJ-Body Jeeps.^{xvii}

SECTION CONCLUSION: NHTSA and Chrysler have been on-notice for decades regarding the inadequacies of the FMVSS process, including specific FMVSS-301 and EA12-005 Jeep fuel system crashworthiness issues. In fact, the portent of the Baker memo was reemphasized in 1985 by the Chrysler ‘**Fuel Supply Systems - Design Guidelines.**’^{xviii}

Safety Defect Admissions by Chrysler are Legally Indistinguishable from General Motors'

Of the 19 letters that I sent to you, ten have been copied to FCA Chairman Sergio Marchionne.^{xix} These include the 24Sep2012 letter addressed to Mr. Strickland, which was filed to the NHTSA website under EA12-005.

I included photographs of the Jeep Grand Cherokee fuel tank, which failed when tested by CAS in May 2011.^{xx} I also highlighted the 7Sep2012 deposition of fire causation expert Mr. Robert Banta. As a former Chrysler employee, having direct knowledge of these issues, his testimony was offered by Chrysler in the fire-death case of Mrs. Susan Kline. When confronted with these photographs, Mr. Banta testified as follows (ATTACHMENT 1):

Question: Now, in looking at that photo, can you tell me what part of the vehicle protects the part of the tank that we're looking at in that photograph?

Witness: *No. It's covered by the fascia.*

Question: So if a vehicle were to strike just that yellow piece of the car, whether it be because it's lower or some kind of vehicle that's not even a car, let's say it was a recreational vehicle of some sort, what would protect that portion of the tank that we see here in yellow.

Witness: *Just the tank surface itself.*

Question: So in other words, whatever the material of the tank is at the time?

Witness: *The tank's on its own.*

Any honest person would assess this testimony as an open admission of a defect. Chrysler executives and their defense lawyers are fully aware of this admission by their expert and former employee. This admission is not recent, it spans decades of internal and interconnected knowledge at Chrysler. For example, in his July 2007 deposition in the Jeep Grand Cherokee **trailer-hitch fire-death** litigation of 4-year-old Cassidy Jarmon (pictured), Mr. Banta testified as follows:



Question: Mr. Banta, are you familiar with Exhibit 6 (Baker memo)?

Witness: *I have seen this before, yes.*

Question: In what context have you seen this memoranda?

Witness: *I saw this for the first time in some lawsuit, 10, 15, maybe 20 years ago.*

...

Question: And the memo appears to be from Leonard Baker?

Witness: *Yes.*

Question: And at the time he wrote the (Baker) memo, he was manager of automotive safety?

Witness: *Yes.*

Question: Do you know Mr. Baker?

Witness: *I do, yes.*

...

Question: Okay, did you ever work with Mr. Baker?

Witness: *Actually, he worked for me. When he retired he came back as a contract worker gathering up documents like this (Baker memo).*

Safety Defect Status Admissions by Chrysler are Legally Indistinguishable from General Motors' - SUMMARY

- 1) The 1978 Baker memo is distributed to the highest levels of Chrysler management, documenting the inherent defect demonstrated in the real world by the Ford Pinto fuel system design: Rearmost location but unshielded.
- 2) My 1987 recommendation to update the Jeep fuel system design to the N-Body/WK-Body architecture is rejected by the 'Father of the Jeep,' Executive Vice President Francois Castaing.
- 3) Decades of Jeep fire-death cases, including those Jeeps equipped with a trailer hitch, are settled but only if the plaintiff submits to a confidentiality agreement, as in the fire-death of 4-year-old Cassidy Jarmon.

Safety Defect Admissions by Chrysler are Legally Indistinguishable from General Motors' - SUMMARY cont.

- 4) The lead Chrysler defense expert, Mr. Robert Banta admits that the author of the Baker memo is not only known to him, but that Mr. Baker had worked for him! ^{xxi}
- 5) Later Mr. Banta admits that the unprotected Jeep fuel tank designs are essentially no different than that of the defective Ford Pinto by declaring, *"The tank's on its own."*
- 6) To testify that *"The tank's on its own"* is equivalent to admitting that the public is on its own, and therefore rhetoric regarding Jeep compliance to FMVSS-301 borders on the criminal misrepresentation.

The admissions by Chrysler of their long-standing knowledge of an inherent safety defect in the EA12-005 Jeeps are indistinguishable, at the moralistic and legal levels, from those admissions recently made by GM:

- a) These admissions by GM resulted in a senatorial review of its ignition switch product liability settlements.
- b) Item a) resulted in reassessment of those settlements. Plaintiffs have petitioned to reopen prior litigations which were settled with confidentiality agreements, but under duress of non-disclosure/misrepresentation.
- c) The GM motions to dismiss Item b) were denied on 9 August 2014.
- d) With a corporate culture overly influenced by the defense bar, many documents were not forthcoming from GM to NHTSA or to the recent Senate Subcommittee hearings. Similarly, the Baker memo was not disclosed by Chrysler to NHTSA under EA12-005 . . . I was compelled to provide it.

In summary, the entire litigation record involving the horrific injury and death caused by the defective Jeep fuel systems requires Senate review and legal/court reassessment. This review should not be limited to the secret settlements against Chrysler, but also those cases that were mindfully diverted to Chrysler dealerships via the so-called "bankruptcy."

Chrysler, General Motors and NHTSA: A Documented Criminal Record

At the hearings of the Subcommittee on Consumer Protection and Product Safety, Senator Richard Blumenthal stated:

"The more I hear and see in these documents and the more I learn about what happened, the more convinced I am that GM has a real exposure to criminal liability. I think it's legal and appropriate that GM will face prosecution."



Chairwoman Senator Claire McCaskill exclaimed:

"It may be we need to look at the recall procedures in other manufacturers, and if there are these kinds of flaws in this process (at GM), then it might be helpful to at least make an inquiry into the other major manufacturers about their processes."

Senator Blumenthal and Senator McCaskill are both correct.

Exposing the criminal activity of Chrysler management, in November 2004 I testified in the infant death case of Flax v Chrysler, focusing on the "real world" approach to safety by the SLT. Rather than preparing a substantive defense, Chrysler and its experts offered the following familiar, but fraudulent diversion:

"The (Chrysler) seats meet or exceed all federal safety standards and have an outstanding safety record."

Chrysler also expended enormous resources filing, what was described as, "three feet" of exclusion motions. With an explicit purpose of censorship, these motions also besmirched my person, my expertise and my factual knowledge of the issues germane to the death of an 8-month-old infant in a defective Chrysler product. The judge in Flax denied all of the Chrysler exclusion motions, and I was allowed to testify to the Flax jury regarding the criminal activity of Chrysler executives, NHTSA and the Department of Justice (DOJ) :

Chrysler, General Motors and NHTSA: A Documented Criminal Record cont.1. **Crash Test Video and the Public Record:**

- NHTSA has agreed that they will deny all FOIA requests to place their investigative files, including the crash test video, on the public record and that the Department of Justice will defend any lawsuits seeking to compel production under FOIA.

We would agree with NHTSA that their engineering analysis will remain open while we conduct the service campaign to provide them additional bases to argue that release of the materials would interfere with their investigation.

- The Department of Justice says there is less than a 50/50 chance of keeping the video off the record for the full duration of the investigation, i.e. the campaign, if there is a court ruling. Given the possibility that a lawsuit could be filed at any time, they anticipate that the legal process would take at least four months, regardless of the outcome.

The screenshot above is part of a two-page document (ATTACHMENT 2) that confirmed the merits of my testimony: That Chrysler, NHTSA and DOJ were guilty in-general of criminal conspiracy against the taxpayer, but were directly guilty of conspiracy, gross criminal negligence, and manslaughter against subsequent victims of the Chrysler vehicle defects.

The jury in Flax was utterly furious upon hearing my testimony, and awarded the Flax family a verdict of \$105 million. In a news documentary that featured my testimony, Flax plaintiff attorney Leigh Martin-May characterized the Chrysler non-rebuttal to my allegation of criminal activity:



“And I think the whole amazing thing about it is that-that testimony was un rebutted at trial. Chrysler did not bring a single witness to say anything different than what Paul Sheridan had said.

And on cross examination, basically, they had nothing to discredit what Paul Sheridan had said about the merits of his testimony.” xxii

The following bolsters the view that NHTSA has participated in criminal conspiracy:

Just prior to the Flax defense case, NHTSA posted (i.e. buried) in the Federal Register a notification that the fifteen year old petition filed by plaintiff’s expert Dr. Kenneth Saczalski (right, also featured in the February 1992 *60 Minutes*) was “suspended.” The Saczalski petition, which languished for fifteen years sought to fix the flawed FMVSS-207 seat standard. There is evidence that NHTSA officials not only timed this suspension to coincide with the Flax defense case, but that the only party notified of the buried posting was the Chrysler defense lawyers at trial. xxiii



Chrysler, General Motors and NHTSA: A Documented Criminal Record cont.

With respect to the quotes of Senator Blumenthal and Senator McCaskill, relevance regarding the two evidence stickers of ATTACHMENT 2 follows:

- The lower right deposition sticker identifies Chrysler Chairman Robert Eaton. Prior to this position he was an high executive at General Motors.
- The upper right deposition sticker identifies Chrysler President Robert Lutz; he is a two-time former executive of GM. Lutz was at GM prior to becoming Chrysler President, and then returned to GM in August 2001 as Chief Operating Officer during the period when the defective ignition switch was being designed. Below he is seen driving the original 1993 ZJ-Body Jeep Grand Cherokee through a plate glass window at its introduction at the International Automobile Show in Cobo Hall (Detroit, MI) on January 7, 1992:



In depositions these former GM executives openly touted participation in criminal conspiracy. During the conspiracy additional severe injury and death was inflicted upon defrauded Chrysler customers. ^{xxiv}

In January 1995 Chrysler memos to Chrysler Chairman Bob Eaton confirm participation by GM in matters related to the Chrysler/NHTSA/DOJ conspiracy. GM and Chrysler internal lawyers were not only co-conspirators, these lawyers were co-authors of a letter written for signature by Michigan Congressman John Dingell. Ironically for the instant subject, this Dingell letter sought to discredit the fire-death investigation of defective and unprotected C/K pickup truck fuel tanks!

Relating to the Senator McCaskill quote, throughout the criminal conspiracy discussed above Michael Millikin, current Executive Vice President & General Counsel, who recently testified at the Senate Subcommittee, was an ‘internal lawyer’ who headed all litigation practices for GM. This history is touted at his GM personnel webpage.

Chrysler Failure to Act Under the Gross Criminal Negligence Law

In the Supreme Court case of *Citizens United v. Federal Election Commission*, five of the nine of the justices confirmed their corrupted status by declaring that corporations are essentially people when it comes to corporate campaign cash.

This ruling was welcomed by Michigan Congressman John Dingell. ^{xxv}

But this Court decision magnifies an historical reality: If an ordinary citizen behaved in a manner consonant with that of Chrysler, that citizen would be criminally charged. An accepted definition of ‘Gross Criminal Negligence’ states:

“Gross negligence is culpable or criminal when accompanied by acts of commission or omission of a wanton or wilful nature, showing a reckless or indifferent disregard of the rights of others, under circumstances reasonably calculated to produce injury, or which make it not improbable that injury will be occasioned, and the offender knows, or is charged with the knowledge of, the probable result of his acts.”

A vast majority of the juries that have served in product liability cases involving Chrysler would opt for criminal charges if they were charged with that deliberation. Paraphrasing Senator Blumenthal, the long history of Chrysler and NHTSA provides more than enough evidence for **“real exposure to criminal liability . . . and appropriate . . . prosecution.”**

EA12-005 : The Closed-Door Trailer Hitch Fraud – Manslaughter as History and Context

For two years 1993-1994 the Safety Leadership Team (SLT) recommended that a defect in Chrysler minivans be remedied by a formal safety recall. On November 17, 1994, NHTSA held a closed-door meeting with Chrysler wherein the agency reported its “Conclusion” to EA94-005; a conclusion that confirmed the SLT opinion:

“The (minivan) latch failure is a safety defect that involves children”

This meeting, the identity of the attendees, and this conclusion were never shared with minivan owners. Instead Chrysler and NHTSA solicited and received the conspiratorial assistance of the DOJ. This conspiracy spanned from approximately November 1994 until October 1995. In December 1994 the internal Chrysler Legal department, with participation by outside defense firms, authorized Security to raid my office and confiscate my office and SLT files. ^{xxvi}



In September 1995, during the Chrysler/NHTSA/DOJ conspiracy authorized by former GM executives Robert Eaton and Robert Lutz, **nine-year-old Brandon Auer was killed as a direct result of the “Conclusion” above.**

NHTSA never told Brandon’s parents of the conclusion above prior to their son’s manslaughter. Chrysler did not inform them of the conspiracy prior to their demand for a confidentiality agreement to settle Auer v Chrysler.

NHTSA was fully aware of the above, since both Brandon and I were featured on the October 27, 1995 airing of *ABC News 20/20*. As a consequence of my 88-second interview, under direction of these former GM executives, Chrysler lawyer Thomas Kienbaum sued me for \$82,000,000. No individual in history has been sued for a greater amount. ^{xxvii}

EA12-005 – The Closed-Door Trailer Hitch Fraud – The Trailer Hitch Death of Cassidy Jarmon

It is well-known in the auto industry, that onboard fuel storage systems must be protected from both onboard surfaces and outboard surfaces (colliding vehicle). Regarding onboard surfaces, which may collide with the tank or vice-versa during the collision, the engineering design for crashworthiness includes the vernacular “friendly.”

At no time in auto history has a trailer hitch been included in the engineering designs for crashworthiness of any kind, let alone that of fuel tanks. At no time in history has a trailer hitch been included in the vernacular “friendly.”

During PE10-031, Chrysler submitted a report on the horrific fire-death of four-year-old Cassidy Jarmon.

But this “Jarmon report” was censored from public view under a Chrysler request for “confidentiality” (ATTACHMENT 3). This specific request is not surprising:

- The 1993 ZJ-Body Jeep Grand Cherokee that killed Cassidy had a trailer hitch (See Page 5 above).
- Chrysler censored the deposition in Jarmon of their expert Robert Banta. This testimony predates the recent closed-door fraud, which fantasizes that a trailer hitch adds crashworthiness or “friendliness.” Chrysler and NHTSA have enforced our ignorance about Cassidy.



EA12-005 : The Closed-Door Trailer Hitch Fraud – Secret “Safety” Deals as Morally Vacuous

In August 2012 NHTSA and Chrysler had closed-door meeting for EA12-005, which once again included participation by outside defense firms. Not much came out of this meeting, because not much went in.

In June 2013 NHTSA and Chrysler had another closed-door meeting for EA12-005; this time in a secret location in Chicago. As detailed below, what came out of this meeting constitutes fraud:

- I. Of the vehicles that comprise what is alleged to be a “settlement of differences” (between NHTSA and Chrysler), the 1993 thru 1998 Jeep Grand Cherokee (ZJ-Body) and the 2002 thru 2007 Jeep Liberty (KJ-Body); these are alleged to acquire crashworthiness by virtue of installation of a trailer hitch.
- II. Item II above is to be offered only on those Jeeps that Chrysler dealerships assess have adequate “structure” to accept installation of a trailer hitch. **xxviii**
- III. Those ZJ and KJ Jeeps that are not deemed adequate per Item II are **not** addressed in this so-called safety recall.

NHTSA recall 13V-252 is a fraud. It is technically baseless. And morally vacuous.

EA12-005 : Closed-Door Trailer Hitch Fraud – NHTSA in Servitude to “the Governed”

A ‘*Special Order Directed to Chrysler Group LLC*,’ was issued by NHTSA Counsel O. Kevin Vincent. Written over a year after the closed-door meeting of June 2013, **this July 2014 Order confirms that no prior crash testing to validate the trailer hitch remedy was conducted or demanded prior to NHTSA acquiescence to 13V-252.**

The Order states:

“In response to ODIs concerns, Chrysler provided drawings of the hitches and a limited set of test data. In ODIs view the test data provided by Chrysler was insufficient. However, when asked, Chrysler indicated that it would not conduct any testing or supply more data.”

Chrysler bamboozled the under-funded NHTSA into believing the fraud that a trailer hitch would protect the lives of customers that relied on Chrysler PR rhetoric, and therefore continued to drive the ZJ-Body Jeep Grand Cherokee and the KJ-Body Jeep Liberty. It is no surprise, given the fundamental character of this defect, that deaths subsequently occurred in both models! The horrific death of 17-year-old Skyler Anderson-Coughlin in a Jeep Grand Cherokee is detailed below.

The Order then specifically confirms that no prior crash testing was conducted by either NHTSA or Chrysler:

“Due to concerns about the effectiveness of the proposed remedy, particularly in light of the safety risks posed by rear-impact fuel leaks and fires, NHTSA decided to take the unusual step of conducting its own test program to assess the performance of the hitch in mitigating the risk of rear leaks and fires in rear crashes.”

The Order then asserts that NHTSA no longer has “*any reservations about implementation of Chrysler’s proposed remedy.*” This amounts to the world being turned upside down:

NHTSA is now complying with Chrysler standards.

But as you will note in #9 below, this NHTSA behavior goes far beyond servility, all the way to criminal fraud.

EA12-005 : The Closed-Door Trailer Hitch Fraud – NHTSA in Servitude to “the Governed” cont.

That NHTSA recall 13V-252 is a fraud, technically baseless, and morally vacuous, provokes these initial criticisms:

- 1) Clearly indicating servitude to the governed, NHTSA never consulted with the Petitioner (CAS) prior to cutting their closed-door deal with Chrysler in June 2013.
- 2) NHTSA announced it was “satisfied” with the Chrysler decision to do a “customer service action,” capitulating to the Chrysler rhetoric that 13V-252 was not a safety recall, insinuating that EA12-005 was not a safety concern *per se*, and thereby directly contributed to assimilation by Jeep owners, that were later killed or horribly maimed, that they were not in danger.
- 3) NHTSA never disclosed that this capitulation occurred with no prior crash testing to validate the alleged remedy.
- 4) Chrysler never disclosed to Jeep owners that their alleged remedy was imposed, but with no prior crash testing to validate the vehicle inspection/trailer hitch installation ruse, and further that they refused to conduct any such crash testing per the requirements of the Transportation Safety Act.
- 5) NHTSA crash testing conducted from August 2013 to January 2014 should never have happened. The taxpayer has funded testing, not to confirm that a closed-door deal was technically valid for **real world** fire-injury and fire-death accidents, but merely to bolster NHTSA PR which bold facedly asserts that validity claim.
- 6) It is not a NHTSA responsibility to confirm the technical validity of a defect remedy; that responsibility lies with the manufacturer. Under the results of 13V-252 Chrysler defense lawyers are now in a position to fraudulently argue about the trailer hitch remedy as “government approved.”
- 7) It is not the taxpayers’ job to fund validation of defect remedies in behalf of multi-billion-dollar corporations, **especially those that hid from liability by staging bankruptcy, and had already benefited to the tune of billions is taxpayer funded bailouts.** ^{xxix} Under the Transportation Safety Act it is the responsibility of the industry to propose, test and confirm competent remedies **PRIOR to making public announcements.**
- 8) Of the four vehicle types that place Jeep occupants (and those in accident proximity) at risk, the 1985 thru 2001 Jeep Cherokee (XJ-Body) was dropped from the investigation with no public explanation whatsoever. ^{xxx}
- 9) Crash testing conducted by NHTSA, in behalf of Chrysler, amounts to fraud. NHTSA is fully aware that the “Reconstruction Testing,” claimed to duplicate prior accidents, was NOT representative of severe injury or the Fatal Accident Reporting System (FARS) data. In truth, it is clear that NHTSA obediently and predictably avoided accident reconstructions that would confirm that their trailer hitch “remedy” was indeed a fraud. ^{xxxi}
- 10) Relating to #8 and #9, the 2000 Jeep XJ-Body trailer hitch severe-injury accident of Ana Pina` and her daughter is well-known to NHTSA and their suitors at Chrysler; both organizations have ruthlessly abandoned them:



The “Reconstruction Testing” which closed EA12-005 was intentionally formulated with a philosophy consistent with that of the original Pinto-based FMVSS-301 formulation: **MAKE SURE IT PASSES!** The NHTSA testing under 13V-252 proved very little about Jeep crashworthiness, but much about ongoing NHTSA servility. ^{xxxii}

EA12-005 : The Closed-Door Trailer Hitch Fraud – NHTSA and Chrysler On-Notice Regarding Encapsulation

Of the 19 letters I have sent to you, all were copied to Mr. Strickland, and eleven were copied to FCA Chairman Sergio Marchionne. In 8 letters I discussed the **BASIC** underlying technical philosophy that a viable remedy for EA12-005 must fulfill (encapsulation), and the currently available hardware that approximates that philosophy (skid plate). The table below highlights the frequency I discuss these two remedy items, as well as the frequency for the trailer hitch:

Letters to NHTSA/CAS	Encapsulation	Skid Plate	Trailer Hitch
1 June 2010	0	7	0
9 February 2011	0	15	0
5 December 2011	1	2	0
27 August 2012	17	45	0
3 September 2012	0	1	0
24 September 2012	1	6	0
1 January 2013	1	3	0
12 February 2013	23	41	0

Of the 19 letters that I sent to you, **none** proposed that a trailer hitch can fulfill the requirements of EA12-005. ^{xxxiii}

In my interview with ABC News in September 2009, I reviewed the technical philosophy (encapsulation), and showcased currently available hardware (skid plate). But nowhere in the advertising for the DaimlerBenz designed WK-Body Jeep Grand Cherokee, which has zero fire deaths/injuries, does Chrysler propose that a trailer hitch provides “protection” for **any** underbody component such as a fuel tank. Indeed they emphasize that a skid plate is offered for that purpose.

But later, when the EA12-005 Jeep vehicles were in focus, Chrysler made the following duplicitous submission to the WUSA-TV9 report which aired in June 2012:

“Chrysler Group conducted rear impact testing without skid plates . . . The overwhelming majority of rear impact fires over the life of the ‘93 to ‘04 Jeep Grand Cherokees were the result of high speed, high energy crashes in which a skid plate would have made no difference in the outcome of these tragic events.”

So . . . Chrysler admits in the public domain that it has **not** tested the viability of an encapsulating skid plate, but somehow Chrysler PR and lawyers **know** that “a skid plate would have made no difference” ? Specifically:

- Chrysler and NHTSA never “reconstructed” the accident, that killed four-year-old Cassidy Jarmon, to determine the outcome if, rather than a trailer hitch, that model Jeep Grand Cherokee had a competent skid plate.
- Chrysler and NHTSA never “reconstructed” the accident, that horribly injured Ana Pina` and her daughter, to determine the outcome if, rather than a trailer hitch, that model Jeep Cherokee had a competent skid plate.

Ignoring their ruse about “high speed, high energy crashes,” since Chrysler refused to test their trailer hitch for real world scenarios, one can assert that their non-basis of the June 2013 closed-door proposal constitutes commercial fraud.

EA12-005 : Closed-Door Trailer Hitch Fraud – Safety Recall No. A10 (Chrysler Documents Their Fraud)

Even if none of the above is deemed conclusive, we must return to my letter of 1 June 2010. I begin that letter, not with the Baker memo, but with a detailed discussion of ‘Safety Recall No. A10 – Fuel Tank Blocker Bracket.’

Chrysler claimed that the recall involved only a “**minor**” FMVSS-301 compliance issue on WJ-Body Jeep Grand Cherokees. They also admitted in ‘Safety Recall A-10’ that WJ-Body **Jeeps which already had a skid plate installed needed no further “repair.”**

However, on pages 3, 4 and 5 of the dealership instruction sheets, **Chrysler openly documents the fact that the presence or installation of a trailer hitch could not and did not remedy even the minor crashworthiness issue of non-compliance with the non-stringent Pinto-based FMVSS-301.** Hidden from the public, ‘Safety Recall No. A-10’ has been in NHTSA possession since 2001. At that time NHTSA accepted the Chrysler position that a trailer hitch could not protect a roll-over valve. But now that same agency has capitulated to the fairy tale that a trailer hitch will solve the real world crashworthiness defects of all EA12-005 Jeeps. ^{xxxiv}

The Case of Criminal Manslaughter: Indictments Involving Fire-Death in EA12-005 Jeep (Filed 9 July 2014)

Many will criticize the discussion above, especially the allegations of criminal activity, as strident. Apparently selected judicial and legislative organizations of the United States strongly disagree.



Shown at their arraignment of 9 July 2014, are criminal defendants Rafael Perez Jr. and Joel Nieves-Cruz. **xxxv**

They had nothing to do with the design of any EA12-005 Jeeps. **Like the ‘Father of the Jeep’ Francois Castaing, they know nothing about the term “crashworthiness” (Page 4 above).** At no time have they earned 8-figure incomes while driving Jeeps through plate glass windows (Page 8 above). They are not guilty of conspiracy against the safety and well-being of Chrysler customers. Neither has so much as an outstanding parking ticket.

On the evening of 10 November 2013, these moving men had absolutely no intention of harming anyone.

Unbeknownst to these laypeople, they too were at risk by being in accident proximity to EA12-005 Jeeps, in this instance a 1996 Jeep Grand Cherokee; **the model that became a coffin for Mrs. Susan Kline (ATTACHMENT 4).** As a result of a mistake, and later an error in judgment, both men have been

charged with criminal manslaughter, in connection with the horrific fire-death of 17-year-old Skyler Coughlin-Anderson.

In his indictment to Massachusetts grand jury, Assistant District Attorney James Forsyth declares:

“The defendant(s) herein, of Springfield in the County of Hampton, on or about November 10, 2013, at HAMPTON COUNTY, did assault and beat Skyler Anderson-Coughlin, and by such assault and beating did kill said Skyler Anderson-Coughlin.

Specifically, (defendants), on or about November 10, 2013, having a legal duty of care, did engage in wanton and reckless conduct, and by such conduct did cause the death of Skyler Anderson-Coughlin in violation of General Laws chapter 265 section 13. (ATTACHMENT 5)



The mistake by Nieves-Cruz and Perez involved not securing couch cushions for transport in an open pickup truck, and not anticipating that turbulence while driving up Massachusetts Route 91 would cause the cushions to fly out onto that busy highway. The ‘error in judgment’ was leaving the scene of an accident that their actions are alleged to have caused.



CONCLUSION: The judicial and legislative organizations of Massachusetts have proclaimed that a pair of high school educated men **“did assault and beat Skyler Anderson-Coughlin . . . did engage in wanton and reckless conduct, and by such conduct did cause the death of Skyler Anderson-Coughlin.”** These organizations have ostensibly proclaimed that Nieves-Cruz and Perez murdered young Skyler, pictured at-left.

At no time have those same organizations proclaimed that individuals, who are *directly* responsible for the *true* proximate cause of Skyler’s death, need to be held to the same or more stringent legal and moral standards. In stark contrast to an “error in judgment,” the guilt of college-degreed individuals at Chrysler and NHTSA do not span an instant of mindlessness that accompanied a frantic moment on a nighttime Massachusetts highway. Rather, the guilt of Chrysler and NHTSA has spanned decades. But no prosecutor has ever held these individuals accountable, despite their notorious “wanton and reckless conduct.”

The Chrysler Admission of a Jeep Safety Defect is At Least Equivalent to that of GM's

The three officials on Page 1 have publically claimed that if the Sanchez brothers had been notified, and then had a trailer hitch installed on their 1994 Jeep Grand Cherokee, then they would not have been horribly burned in the 5 April 2014 conflagration pictured on Page 1. ^{xxxvi} These officials made this claim to construction workers, high school students, and elderly husbands & wives burned in these Jeeps. ^{xxxvii}

Would these officials repeat their trailer hitch claim to President Obama and his Family regarding his declaration, “*The first new car that I ever bought was a Grand Cherokee!*” ? ^{xxxviii}

At left, post taxpayer bailout, the President and FCA Chairman Sergio Marchionne are **discussing the German re-designed WK-Body Jeep Grand Cherokee which has zero fire-injuries and zero fire-deaths.**

Chrysler Admission of the Jeep Safety Defect - SUMMARY

1. The entire automotive industry was placed on-notice by the February 1992 *CBS News 60 Minutes* interview with Mercedes-Benz safety engineer Dr. Tom Bologna (Please see page 3 above). NHTSA was therefore placed on-notice that its FMVSS process was “flawed.” It is a matter of history that automobiles that merely complied with the “standards” contained safety defects that were indefensible; intrinsically, morally and in liability lawsuits.
2. NHTSA and Chrysler were placed on-notice that the Safety Leadership Team (SLT) would look to FMVSS as merely a required point, but would pursue safety designs that protected our customers and the public in the “real world.”
3. Chrysler was placed on-notice in 1978, via events leading up to the Baker memo, that continuing to sell vehicles with unprotected fuel tanks was unacceptable, especially tanks that were mounted behind the rear axle. This unacceptable status was later extended to the real world reality that compliance with FMVSS-301 was irrelevant.
4. NHTSA and Chrysler were repeatedly placed on-notice regarding the defective Jeep fuel system, through FARS and Jeep litigation settlements respectively. **This notice was elevated to an admission** when Chrysler fire expert Mr. Robert Banta offered the admission that, despite alleged compliance with FMVSS-301, in the ‘real world’ the EA12-005 Jeeps were defective : “*The tank is on its own!*” (Please see pages 5 and 6 above).

The Closed-Door NHTSA/Chrysler Trailer Hitch “remedy” is a Fraud - SUMMARY

- A. In full knowledge of the June 2011 sworn testimony of the ‘Father of the Jeep’ Francois Castaing, that the “*Tow package (i.e. trailer hitch) does not protect the tank,*” NHTSA proclaimed that they had “*no reservations.*” ^{xxxix}
- B. In full knowledge of a 13-year-old admission under Safety Recall Notice A-10, that a trailer hitch did not and could not remedy minor requirements of the Pinto-based FMVSS-310, NHTSA announced that they were “satisfied” with the Chrysler edict that a trailer hitch was the crashworthiness remedy for EA12-005 Jeeps (See page 12 above). ^{xl}
- C. In full view of my letters, and *ABC News* interview, which detailed the encapsulation concept and the approximation by a competent skid plate, NHTSA accommodated Chrysler’s tactical and legalistic “**anything but**” philosophy, and hurriedly closed EA12-005 on the basis of a skewed, non-representative crash test program that they conducted **after** committing themselves, and Jeep owners, to their closed-door trailer hitch fraud. ^{xli}

Relating to the President Obama statement that the safety of the WK-Body is “world class,” Chrysler never asserts that the trailer hitch is a device that is designed to protect underbody components, such a fuel tank. Instead they loudly advertise WK-Body use of skid plates. On the WK-Body Jeep the mid-mounted fuel tank skid plate is standard, not optional. ^{xlii}

Recommendation 1

Chrysler and NHTSA have made a mockery of your petition of 2 October 2009.^{xliii} This provokes repeating the lucid comment by ‘Subcommittee on Consumer Protection and Product Safety’ Chairwoman Senator Claire McCaskill:

“It may be we need to look at the recall procedures in other manufacturers, and if there are these kinds of flaws in this process (at GM), then it might be helpful to at least make an inquiry into the other major manufacturers about their processes.”

Given that the safety defect admissions by Chrysler are legally indistinguishable from General Motors, I recommend that your petition, EA12-005 and NHTSA Recall 13V-252 be scheduled for general review by the Senate.

Recommendation 2



The incompetence, inaccuracy and outright criminality that frequently accompanies the NHTSA/Auto Industry FMVSS “strawman” can be directly connected to the injury and death of the innocent. This provokes repeating the summary comment by ‘Subcommittee on Consumer Protection and Product Safety’ member Senator Richard Blumenthal:

“The more I hear and see in these documents and the more I learn about what happened, the more convinced I am that GM has a real exposure to criminal liability. I think it's legal and appropriate that GM will face prosecution.”

Given the manslaughter indictment of two moving men in Massachusetts, who had the misfortune of being in proximity to an EA12-005 Jeep, it is possible that prosecutorial and legislative organizations are finally serious about auto safety. The five year “investigation” and fraudulent closure of EA12-005 requires senatorial scrutiny. I recommend that EA12-005 and Recall 13V-252 be scheduled for review by the Senate Subcommittee on Consumer Protection and Product Safety, with a focus on Chrysler accountability for the crimes of gross criminal negligence, criminal fraud, and manslaughter.^{xliv}

Recommendation 3

President Obama ignored my 11 June 2009 request to review the *“Two-time victims in Chrysler's bankruptcy.”*^{xlv} It is well-known that **the Chrysler bankruptcy had a hidden and specific goal**: The vacating of not only the Jeep fire-death litigations, but *all* liability lawsuits. My file includes lengthy facsimile pages that contain complex legal machinations, which are time-stamped mere minutes (!) after Judge Arthur J. Gonzalez granted bankruptcy protection on 1 June 2009.

I state the following with great reserve: When one analyzes the lethality and horrific injury/death outcomes that result from provoking the fuel system defect in the EA12-005 Jeeps, comparing such to the GM ignition switch defect, it is clear that the former is deserving of **at least** the same level of public scrutiny.



Given Page 14 above, *“The Chrysler Admission of a Jeep Safety Defect is At Least Equivalent to that of GMs,”* I recommend that EA12-005 and Recall 13V-252 be scheduled for review by the ‘Senate Subcommittee on Consumer Protection and Product Safety,’ with a specific focus on the legal and moral need to re-open the vacated Jeep fire-death litigations. The latter was a conscious, albeit insidious goal of “bankruptcy.” This recommendation includes creation of a Fiat Chrysler Automobiles fund similar to that formed for GM victims; the latter is being overseen by compensation expert (and former Massachusetts resident) Mr. Kenneth R. Feinberg.^{xlvi}

Recommendation 4

Immediately subsequent to the “Chrysler bankruptcy” in June 2009, the Obama Administration initiated the “*Cash for Clunkers*” program. The formal name was the ‘Car Allowance Rebate System’ or CARS, which was in effect during July and August 2009. The economic theme of CARS originated with the Council of Economic Advisors, whom formulated a rebate to customers who traded-in a vehicle of 18 or fewer mpg and purchased at least 22 mpg. The CARS subsidy was \$3,500 if their fuel economy improved by four to nine mpg, or \$4,500 if it improved by 10 or more mpg. There was also an intent within CARS to further protect the environment. Both are laudable goals.

On Page 10 above I discussed:

“. . . installation of a trailer hitch . . . is to be offered only on those Jeeps that Chrysler dealerships assess have adequate “structure” to accept installation of a trailer hitch.”

As you recently noted, Jeep owners are now being told, by Chrysler dealerships, that their Jeeps, which allegedly do not have adequate “structure,” **cannot be offered the trailer hitch “remedy.”** These customers are being told that their Jeep have a defectively designed fuel system: A fuel tank that is rear-mounted, below the rear bumper, and unprotected. But under NHTSA Recall 13V-252, because the dealers can allege “corrosion,” their vehicles are no longer road worthy. In one instance the customer was told that because his Jeep Grand Cherokee had “Level 5 corrosion,” the trailer hitch “remedy” would not be offered. The dealer then demanded that this customer sign a waiver alleviating dealership accountability for his safety & well-being when he drove off the dealer lot. As of this writing the customer has refused to sign the demanded waiver, and his Jeep Grand Cherokee is sitting in the dealership lot . . . rusting?

This vehicle confiscation routine under NHTSA Recall 13V-252 was never disclosed to the public by the three officials pictured on Page 1. ^{xlvi} It is clear, from the Chrysler/Chrysler dealership refusal to remedy these defective vehicles, (now) on the basis of “corrosion,” that **these vehicles pose an immediate danger, and must be removed from service.**

Given that a large population of the EA12-005 Jeeps may now be publically deemed by Chrysler and NHTSA to be non-roadworthy, I recommend that the ‘Subcommittee on Consumer Protection and Product Safety’ review this aspect of NHTSA Recall 13V-252 with a focus on advising the Obama Administration on a “**Cash for Safety**” program. In this instance, similar to CARS, a “Cash for Safety” program would benefit the economy, the environment, and public safety.

Summary Comment

As I have stated publically and at trial, and in stark contrast to the recent PR speech by NHTSA Counsel Kevin Vincent:

“Safety is not an engineering issue *per se*. First and foremost, safety is a management issue.” ^{xlvi}

Please do not hesitate to contact me at any time.

Respectfully yours,

Paul V. Sheridan

Endnotes:

i <https://docs.google.com/file/d/0B1u8xcSGDroemwtRDMxeTJFTVE/edit?pli=1>

<http://losangeles.cbslocal.com/2014/07/18/exclusive-2-men-burned-in-fiery-jeep-crash-sue-chrysler/>

ii http://www-odi.nhtsa.dot.gov/cars/problems/defect/results.cfm?action_number=EA12005&SearchType=QuickSearch&summary=true

iii <http://pvsheridan.com/SLT-FormationLtr.pdf>

iv <http://pvsheridan.com/SLT-3-16-1993-Agenda.pdf>

v Dr. Tom Bologna is interviewed in the second link, Part II.

<https://www.youtube.com/watch?v=YeTHbDKPyc8&list=UUBurCYLuIg9Li7-SeIdsuDg>

<https://www.youtube.com/watch?v=FXIVHwX-rvQ&list=UUBurCYLuIg9Li7-SeIdsuDg&index=53>

vi http://pvsheridan.com/MB-Seat_Ad.pdf

vii



The in-trial testimony of Paul V. Sheridan in \$105 million Flax v Chrysler case is shown @4:45 of the second link, Part 2 below:

<https://www.youtube.com/watch?v=34ajMfqwtgd&list=UUBurCYLuIg9Li7-SeIdsuDg>

<https://www.youtube.com/watch?v=u7OAKEaTuPM&index=41&list=UUBurCYLuIg9Li7-SeIdsuDg>

viii http://pvsheridan.com/NHTSA-Sachs-April1995_TripReport.pdf

ix I reviewed FMVSS-207 history because it is representative of the flawed FMVSS process:

<https://www.youtube.com/watch?v=VDwLoGsCdRA&list=UUBurCYLuI9Li7-SeIdsuDg&index=66>

<https://www.youtube.com/watch?v=8uaPvqT1qOO&index=43&list=UUBurCYLuI9Li7-SeIdsuDg>

<https://www.youtube.com/watch?v=b9WAaAKT8W8&index=58&list=UUBurCYLuI9Li7-SeIdsuDg>

<https://www.youtube.com/watch?v=fFI1SuWu-2A&index=57&list=UUBurCYLuI9Li7-SeIdsuDg>

x http://pvsheridan.com/Baker-Sinclair_FuelMemo1978.pdf

xi http://pvsheridan.com/Viergutz-Kline-EX_002.pdf

xii http://pvsheridan.com/FJC-ORG-Chart_EX_001.pdf

xiii <http://car-data.com/jeep-grand-chokeee-a-true-jeep-with-a-bit-of-benz-p1220-110.htm>

xiv The relevant discussion begins on page 64: <http://pvsheridan.com/Castaing-14Jun11-Complete----.pdf>

xv <https://www.youtube.com/watch?v=25roI1nhOwI&list=UUBurCYLuI9Li7-SeIdsuDg&index=60>

The relevant portion of the Castaing deposition is here:

<http://pvsheridan.com/CastaingTenagliaDep-Jeep-Partial.pdf>

xvi <http://www.autosafety.org/statement-ralph-nader-re-jeep-grand-chokeee-fires>

xvii

http://www-odi.nhtsa.dot.gov/cars/problems/defect/results.cfm?action_number=EA12005&SearchType=QuickSearch&summary=true

xviii For example, on Page 3 of the 1985 Chrysler ‘Fuel Supply Systems Design Guidelines.’, Engineering emphasizes:

“The (fuel) tank should be located in a manner that avoids known impact areas, and provides isolation from the passenger compartment.”

The N-Body based Jeep Grand Cherokee that I recommended in 1987 adhered to the warnings of the Baker memo, and the basics stated in the Chrysler ‘Fuel Supply Systems Design Guidelines.’. In stark contrast, the ZJ-Body, like the 1970s XJC-Body that it was based on, along with the later WJ-Body and KJ-Body, had designs that actually exasperated the defective layout of the Ford Pinto, by virtue of a higher ride height (especially in four-wheel-drive versions) and blatant exposure to direct impact by rearmost location:

http://pvsheridan.com/Chrysler_Fuel_Supply_Systems_Design_Guidelines.pdf

xix The 19 letters, eleven were copied to the Fiat Chrysler Automobiles Chairman Sergio Marchionne (chronological):

<http://pvsheridan.com/Sheridan2Ditlow-1-1June2010.pdf>

<http://pvsheridan.com/Sheridan2Strickland-1-9Feb2011.pdf>

<http://pvsheridan.com/Sheridan2Strickland-2-27Sep2011.pdf>

<http://pvsheridan.com/Sheridan2Strickland-3-5Dec2011.pdf>

<http://pvsheridan.com/Sheridan2Congress-2-Links-secure.pdf>

<http://pvsheridan.com/Sheridan2Kelleher-1-11Apr2012.pdf>

<http://pvsheridan.com/Sheridan2Strickland-4-15Jun2012.pdf>

<http://pvsheridan.com/Sheridan2Strickland-5-27Jul2012.pdf>

<http://pvsheridan.com/Sheridan2Strickland-6-27Aug2012.pdf>

<http://pvsheridan.com/Sheridan2Strickland-7-3Sep2012.pdf>

<http://pvsheridan.com/Sheridan2Strickland-8-24Sep2012.pdf>

<http://pvsheridan.com/Sheridan2Strickland-9-1Jan2013.pdf>

<http://pvsheridan.com/Sheridan2Strickland-10-30Jan2013.pdf>

<http://pvsheridan.com/Sheridan2Strickland-11-12Feb2013.pdf>

<http://pvsheridan.com/Sheridan2Elkann-1-15Mar2013.pdf> (Shipped-to and signed-for in Italy)

<http://pvsheridan.com/Sheridan2Strickland-12-18Mar2013.pdf>

<http://pvsheridan.com/Sheridan2Foxy-1-3May2013.pdf>

<http://pvsheridan.com/Sheridan2Strickland-13-12June2013.pdf>

<http://pvsheridan.com/Sheridan2Ditlow-2-31May2014.pdf>

xx http://pvsheridan.com/CAS-Karco-PVS-ZJ_Tank_Failure.pdf

xxi The relevant portion of Mr. Banta's admission that he know Mr. Baker (ala the Baker memo) begins on pdf page 5 of 8:

http://pvsheridan.com/Banta-PartialDep_7-31-2007-JARMON-Knows%20Baker.pdf

xxii For a complete understanding of the NHTSA/Chrysler/DOJ conspiracy please see:

<http://pvsheridan.com/DOJ-NHTSA-ChryslerConspiracy-1.pdf> (large file)

An excerpt from the above link documents those death and severe injuries that occurred WHILE the NHTSA/Chrysler/DOJ conspiracy was in play:

<http://pvsheridan.com/DOJ-NHTSA-ChryslerConspiracy-DeathsDuringOngoing.pdf>

When examined in the context of these two links, and much more, it is clear that Chrysler dismissal of my person during the Christmas holidays of 1994 was also merely an extension of their criminal conspiracy. Further insight into Chrysler criminal behavior whenever a current or former employee is critical is safety is partially obtained by the testimony of John Sparhawk in the \$58 Million Mohr v Chrysler death case. The relevant and shocking testimony begins on transcript page 1047:

<http://pvsheridan.com/Sparhawk-Mohr-Testimony-Sue-Sheridan-Portion.txt>

For equally shocking insight into what automotive safety advocacy, and expert testimony spawns in the legal system, we review what has come to be known as the "Tyrell email." This email, authored by Chrysler lead national defense counsel David Tyrell, and was filed as part of a "re-muzzling" motion by President of the Michigan Bar Association Thomas Kienbaum:

<http://pvsheridan.com/Tyrell-Email-Watts.pdf>

xxiii From the following link, quoted below:

<http://www.butlerwooten.com/Top-Ten-Verdicts/Flax-Verdict.shtml>

“At 9:00 a.m. on the morning of November 16, 2004, during the presentation of Chrysler’s evidence at trial, Chrysler’s lawyer introduced a posting by NHTSA that very morning in the Federal Register, announcing that it was suspending its study. Defense counsel argued that announcement ‘gutted’ plaintiffs’ case. Plaintiff responded that it simply confirmed what the evidence had already demonstrated - that NHTSA was never going to do anything about seat safety. Plaintiff also pointed out that the sudden NHTSA announcement was not coincidental - that it was timed for use by Chrysler at this trial. **NHTSA notified no one of its decision except Chrysler.** NHTSA did not even notify the scientist who had started the issue by filing a petition 15 years before, Dr. Ken Saczalski. The decision was no coincidence: NHTSA’s current Chief Counsel is Jacqueline Glassman, who came to NHTSA from the legal staff of Chrysler, and the past Associate Administrator of NHTSA for Rulemaking, Barry Felrice, now works for Chrysler.

‘NHTSA has become a fraud, James Butler said after the trial. ‘It’s got a revolving door - those in charge come from the auto industry and leave to go to the auto industry, and they keep the technical staff from getting anything done to improve safety.’ **In fact, nearly every top official of NHTSA since 1981 has gone to work for the auto industry upon leaving the agency.**” (Bolding added)

xxiv It should be noted that the 1993 ZJ-Body Jeep Grand Cherokee that two-time former General Motors executive and Chrysler President Robert Lutz drove through a plate glass window at Cobo Hall Auditorium on January 7, 1992 was a four-wheel-drive Laredo Edition. The plate glass event begins @3:15:

<https://www.youtube.com/watch?v=rRcaoRnfDdg>

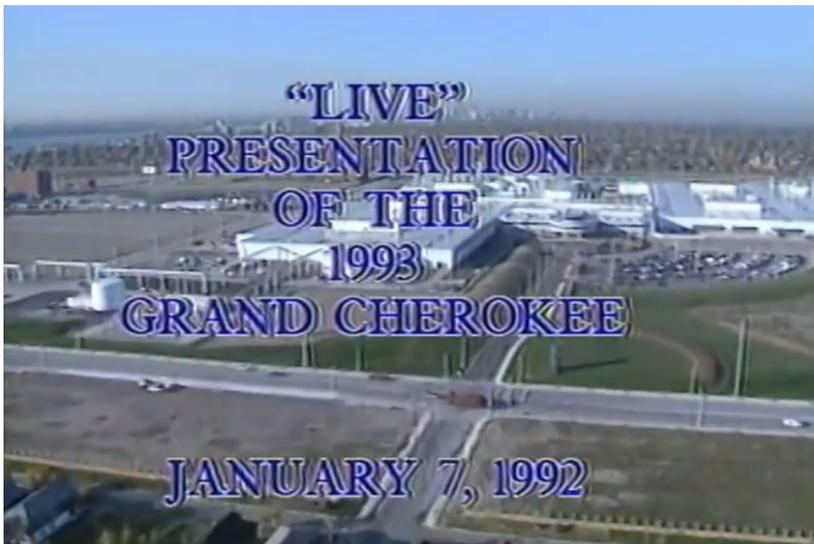

xxv <http://pvsheridan.com/Chrysler2CongressDingell.pdf>

xxvi http://pvsheridan.com/Chrysler_Raid_Sheridan-Office.pdf

xxvii http://pvsheridan.com/82_million.pdf

<http://pvsheridan.com/Sheridan-PerfApprls.pdf>

xxviii Many automotive product litigations filed against pre-bankruptcy Chrysler were dropped due to that tactical protection, and refocused on the Chrysler dealerships as part of the legal ‘chain of commerce.’ The dealership defense lawyers, regardless of the overriding laws at the state level, have deployed a “*my client knows nothing*” defense, with a focus on bamboozling the naïve jury members. However, this action under EA12-005 and Recall 13V-252 clearly confirm that both NHTSA and Chrysler have a full understanding of the expertise and knowledge of the automotive dealership networks. By openly stating that they will rely on their dealers to effect the “inspection” portion of 13V-252, Chrysler is also confirming that, contrary to the “*my client knows nothing*” defense, safety issues and expertise are also the expected purview of the dealer.

xxix http://www.whitehouse.gov/the_press_office/Obama-Administration-Auto-Restructuring-Initiative

xxx Perhaps the most egregious indicators of NHTSA behavior is borne by former Administrator David Strickland. He oversaw the deletion, without any explanation whatsoever, of the XJ-Body Jeep Cherokee from the EA12-005 investigation. The XJ-Body has utilized both steel and plastic versions of the fuel tank. Strickland deleted the XJ-Body while simultaneously proposing/capitulating to the trailer hitch fraud. But Strickland's inaccuracy is two-fold. On 1 July 2013, mere weeks after his secret closed-door meeting with Fiat Chrysler Automobiles Chairman Sergio Marchionne, Strickland met face-to-face with **XJ-Body trailer hitch victim Ana Pina`**. This meeting was arranged by automotive safety advocated Jenelle Embrey. The transcript and audio recording of that meeting is here:

<http://pvsheridan.com/NHTSA-Meeting-Transcript-1Jul2013.docx>

<http://pvsheridan.com/NHTSA-Meeting-Audio-1Jul2013.WMA> (large WMA file)

Within a few months of his fraudulent closure of EA12-005 and therefore his criminal mistreatment of Ms. Pina`, Mr. Strickland resigned from NHTSA to assume a lucrative position with a Washington based K-Street law firm that is notoriously pro-Chrysler:

<http://www.stnonline.com/home/latest-news/5839-former-nhtsa-administrator-strickland-joins-dc-law-firm>

In other words, Strickland unilaterally deleted the XJ-Body from EA12-005 scrutiny, and thereby eliminated any need for a trailer hitch based, albeit fraudulent "reconstruction." This in-turn obviated any genuine crash testing to "reconstruct" the accident that afflicted Ana Pina`. Frankly I am astounded by Mr. Strickland's mistreatment of Ms. Ana Pina`.

xxxi The taxpayer and the EA12-005 Jeep owners/customers are concerned about accident scenarios wherein a rear-end collision will cause a gasoline leak, of any degree, to the unprotected Jeep fuel tank system.

However, their greater concern, and what should have been the PRIMARY concern of NHTSA/Chrysler UNDER THE LAW, was reconstruction of those historical accidents wherein a leak and a catastrophic fire occurred. However, in order to obviate the chance of invalidating their trailer hitch fraud, **NHTSA avoided crash testing of the ilk that would have "reconstructed" the accidents that killed Mrs. Susan Kline:**

https://www.youtube.com/watch?v=TH_0izSyPk0&list=UUBurCYLuIg9Li7-SeIdsuDg

or the elderly couple Mr. Joseph Digiovanni and his wife Esther:

<https://www.youtube.com/watch?v=KV2CnFIIN2M>

or 17-year-old Mr. Skyler Anderson-Coughlin:

<https://www.youtube.com/watch?v=AWDt7JhyndA&list=UUBurCYLuIg9Li7-SeIdsuDg>

or the fire-death of 4-year-old Remington Walden-Cole:



<https://www.youtube.com/watch?v=97oqswkI14k>

In fact, in terms of the horrific fire-death of young Remington, Mr. Strickland has deleted all “Reconstruction Testing” of the 1999 thru 2004 WJ-Body Jeep Grand Cherokee, claiming that “inspection of structure” and installation of a trailer hitch will suffice. But since the WJ-Body that Remington burned to death in may have had a trailer hitch, this Strickland proposal is ludicrous.

Instead Mr. Strickland left his position as NHTSA Administrator **PRIOR** to completion of “Reconstruction Testing” he authorized, which has not and will never confirm that the trailer hitch remedy for the crashworthiness issues of his E12-005 Jeeps is viable:

<http://www-odi.nhtsa.dot.gov/acms/cs/jaxrs/download/doc/UCM458003/INRP-EA12005-59675.pdf> or

http://pvsheridan.com/EA12005-Reconstruction_Testing.pdf

xxxii A very thorough and competent review of the Ana Pina` tragedy by WNDU-16 South Bend, Indiana reporter Megan Hickey:

<http://www.wndu.com/home/headlines/Jeep-Recall-Anas-Story---Part-1-267983271.html>

<http://www.wndu.com/home/headlines/Jeep-Recall--268191502.html>

<http://www.wndu.com/home/headlines/Jeep-Recall-Recall-under-fire----Part-3-268361522.html>

If these WNDU-16 report links expire, please see:

<https://www.youtube.com/watch?v=3xCOFEwgxYE&list=UUBurCYLuIg9Li7-SeIdsuDg>

<https://www.youtube.com/watch?v=FvHOp5sa-P0&list=UUBurCYLuIg9Li7-SeIdsuDg&index=2>

<https://www.youtube.com/watch?v=Mw07BU3g4ZY&list=UUBurCYLuIg9Li7-SeIdsuDg&index=3>

xxxiii For a detailed cost review of the encapsulation and skid plate remedy proposal, please note discussion in the following link, beginning on cover letter Page 4 of 9 here, entitled “Proposed EA-012 Recall Remedy – Preliminary Document Review” :

<http://pvsheridan.com/Sheridan2Strickland-11-12Feb2013.pdf>

xxxiv <http://pvsheridan.com/JeepFuelTankBlockerRecall.pdf>

xxxv Rafael Perez Jr. and Joel Nieves-Cruz plead 'Not Guilty' to criminal manslaughter in connection with the Jeep Grand Cherokee fire-death of 17-year-old Massachusetts resident Skyler Anderson-Coughlin:



https://www.youtube.com/watch?v=hzve_cmBj8Q

http://www.masslive.com/news/index.ssf/2014/07/rafael_perez_jr_joel_nieves_cr.html

xxxvi http://pvsheridan.com/Sanchez_versus_Chrysler.pdf

xxxvii <https://www.youtube.com/watch?v=1aMrybuK6JQ&list=UUBurCYLuIg9Li7-SeIdsuDg>

<http://www.osbornefuneralhome.net/obituary.aspx?MemberId=132098&MName=Esther%20%20DiGiovanni>

xxxviii



<https://www.youtube.com/watch?v=cGrOacZvFs4&list=UUBurCYLuIg9Li7-SeIdsuDg>

xxxix



<https://www.youtube.com/watch?v=BQt3LbwcLL8>

xI



“The trailer hitch is a sham . . . Chrysler is just putting up a game of smoke-n-mirrors on this.”

Clarence Ditlow, EA12-005 Petitioner, Director at the Center for Auto Safety

<https://www.youtube.com/watch?v=00HuIp6EzNE&index=10&list=UUBurCYLuIg9Li7-SeIdsuDg>

xli



<https://www.youtube.com/watch?v=pL4yFeQBN-A&list=UUBurCYLuIg9Li7-SeIdsuDg>

xlii <https://www.youtube.com/watch?v=Qs6S9p73VUo&list=UUBurCYLuIg9Li7-SeIdsuDg&index=43>

xliii It should be noted, as an indication of “care,” that despite repeated invitations to no less than six crash tests of EA12-005 Jeeps and competitive SUVs, Chrysler and/or its experts failed to attend.

<http://www.autosafety.org/1993-2004-jeep-grand-cherokee-recall-petition-0>

xliv Mr. Feinberg should reference the events described in Endnote XXXIII.
<http://dealbook.nytimes.com/2014/07/21/the-difficulty-in-holding-executives-accountable/>

xlv <http://pvsheridan.com/Obama-victims-1-June2009.pdf>

xlvi http://www.nytimes.com/2014/08/02/business/victims-begin-filing-claims-in-gm-case.html?_r=0

xlvii One such dealership whom has denied return of a customer’s EA12-005 Jeep Grand Cherokee is Watson Benzie LLC of Benzonia, Michigan : <http://www.watsonchryslerdodgejeep.com/index.htm>

xlviii <http://pvsheridan.com/Sheridan-SafetyLeadershipAward.pdf>

ATTACHMENT 1

20 August 2014

Mr. Clarence Ditlow, Director
Center for Auto Safety
Suite 330
1825 Connecticut Ave, NW
Washington, DC 20009-5708
(202) 328-7700

Subject: Proposal for Criminal Investigation of Chrysler, and Senatorial review of NHTSA EA12-005

Reference 1: Senator Claire McCaskill, Senate Subcommittee on Consumer Protection/Product Safety

Reference 2: Criminal Manslaughter Indictments Filed Involving Fire-Death in EA12-005 Jeep

Four Pages

When confronted with the above by plaintiff attorney Angel DeFilippo, Mr. Banta testified as follows:

Question: Now, in looking at that photo, can you tell me what part of the vehicle protects the part of the tank that we're looking at in that photograph?

Witness: No. It's covered by the fascia.

Question: ***So if a vehicle were to strike just that yellow piece of the car***, whether it be because it's lower or some kind of vehicle that's not even a car, let's say it was a recreational vehicle of some sort, what would protect that portion of the tank that we see here in yellow.

Witness: Just the tank surface itself.

Question: So in other words, whatever the material of the tank is at the time?

Witness: ***The tank's on its own.***

Any honest person would assess this testimony as an open admission of a defect.

Paul V. Sheridan
DDM Consulting
22357 Columbia Street
Dearborn, MI 48124-3431
313-277-5095
pvs6@cornell.edu

**ZJ-Body Jeep Grand Cherokee:
Typical Customer View (of Fuel Tank)**



**ZJ-Body Jeep Grand Cherokee:
What Showroom Customer Would See if
Fuel Tank was not color-matched to rear
underbody / rear suspension components.**



Photograph by Karco Engineering



Approximate Lower Edge of "bumper," leaving over seven inches of fuel tank unprotected from direct or underride impact.

Open-ended frame rail where bumper bracket is inserted for mounting.

Unprotected Polyethylene fuel tank



Tire Size: LT235/75R15

Upper edge of "structure" at approximately 21.25 inches, which leaves over 7 inches of unprotected fuel tank; unprotected from/during up to 270 degrees of impact angles.

Approximate Lower edge of bumper

Distorted slightly by camera angle, lower portion of polyethylene fuel tank (for this vehicle) at approximately 14 inches above ground (when vehicle suspension is not burdened).

ATTACHMENT 2

Mr. Clarence Ditlow, Director
Center for Auto Safety
Suite 330
1825 Connecticut Ave, NW
Washington, DC 20009-5708
(202) 328-7700

20 August 2014

Subject: Proposal for Criminal Investigation of Chrysler, and Senatorial review of NHTSA EA12-005

Reference 1: Senator Claire McCaskill, Senate Subcommittee on Consumer Protection/Product Safety

Reference 2: Criminal Manslaughter Indictments Filed Involving Fire-Death in EA12-005 Jeep

Two Pages

Chrysler, NHTSA and DOJ were guilty in-general of criminal conspiracy against the taxpayer, but directly guilty of conspiracy against prior and subsequent victims of Chrysler vehicle defects.

The jury in Flax was utterly furious upon hearing my testimony, and awarded the Flax family a verdict of \$105 million. Plaintiff attorney Leigh Martin-May characterized the Chrysler rebuttal to my allegation of criminal activity:

“And I think the whole amazing thing about it is that-that testimony was unrebutted at trial. Chrysler did not bring a single witness to say anything different than what Paul Sheridan had said.

And on cross examination, basically, they had nothing to discredit what Paul Sheridan had said about the merits of his testimony.”

Memo

- The lower right deposition sticker identifies then Chrysler Chairman Robert Eaton. Prior to this position he was an executive at General Motors.
- The upper right deposition sticker identifies then Chrysler President Robert Lutz; he is a two-time former executive of GM. Lutz was at GM prior to becoming Chrysler President, and then returned to GM in August 2001 as Chief Operating Officer, during the period when the defective ignition switch was being designed.

Paul V. Sheridan
DDM Consulting
22357 Columbia Street
Dearborn, MI 48124-3431
313-277-5095
pvs6@cornell.edu



MINIVAN LATCH ISSUE

Proposed Agreement with NHTSA

1. Crash Test Video and the Public Record:

- NHTSA has agreed that they will deny all FOIA requests to place their investigative files, including the crash test video, on the public record and that the Department of Justice will defend any lawsuits seeking to compel production under FOIA.

We would agree with NHTSA that their engineering analysis will remain open while we conduct the service campaign to provide them additional bases to argue that release of the materials would interfere with their investigation.

- The Department of Justice says there is less than a 50/50 chance of keeping the video off the record for the full duration of the investigation, i.e. the campaign, if there is a court ruling. Given the possibility that a lawsuit could be filed at any time, they anticipate that the legal process would take at least four months, regardless of the outcome.

2. Service Action Only - No Recall: NHTSA has agreed that a Chrysler service campaign would fully satisfy all of their concerns and they would give full public support to such an effort. The critical elements that differentiate the service campaign from a recall (mostly reflected in the two attached letters) are as follows:

- no admission of defect or safety problem;
- stated purpose of the campaign - to ensure peace of mind in light of media coverage;
- campaign does not count as a NHTSA action - not included in NHTSA recall numbers, no Part 573 or Part 577 letters;
- statements to owners, the public and NHTSA assert that no defect has been found; and
- NHTSA acknowledges that replacement latch is not a 100% solution.

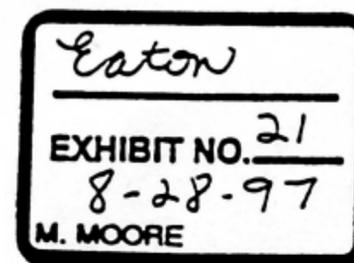

3. **Chrysler Announcement:** Chrysler controls publication of its action with the following provisions:

- Chrysler goes first with its own statement and reads approved NHTSA statement supporting Chrysler's action;
- Chrysler characterizes campaign as done solely to ensure the peace of mind of its owners, i.e. "your concern is our concern";
- Letter from Martinez to Chrysler and NHTSA press statement praise Chrysler action as fully satisfying all of NHTSA's concerns and state that Chrysler is a safety leader;
- NHTSA officials acknowledge publicly that there has been no finding of defect and that there will be none; and
- NHTSA officials acknowledge that owners should not be concerned over the delayed implementation of the action and that they can best protect themselves by keeping seat belts buckled at all times.

4. **Additional Provisions:** The following points have been requested by NHTSA and appear to be reasonable:

- The letter to owners makes reference to the NHTSA hot line phone number;
- Latch replacement will be offered as part of any routine minivan servicing (once replacement latches are available);
- Chrysler will submit six quarterly reports on the progress of the campaign (helps to support defense of FOIA requests); and
- NHTSA can make reference to the service campaign in response to owner inquiries.

ATTACHMENT 3

Mr. Clarence Ditlow, Director
Center for Auto Safety
Suite 330
1825 Connecticut Ave, NW
Washington, DC 20009-5708
(202) 328-7700

20 August 2014

Subject: Proposal for Criminal Investigation of Chrysler, and Senatorial review of NHTSA EA12-005

Reference 1: Senator Claire McCaskill, Senate Subcommittee on Consumer Protection/Product Safety

Reference 2: Criminal Manslaughter Indictments Filed Involving Fire-Death in EA12-005 Jeep

One Page

During PE10-031, Chrysler submitted a report on the horrific fire-death of four-year-old Cassidy Jarmon. But this “Jarmon report” was censored from public view under a Chrysler request for “confidentiality” (ATTACHMENT 3). This specific request is not surprising:



The 1993 ZJ-Body Jeep Grand Cherokee that killed Cassidy had a trailer hitch (See Page 5 above).

Chrysler censored the deposition in Jarmon of their expert Robert Banta. This testimony predates the recent closed-door fraud, which fantasizes that a trailer hitch adds crashworthiness or “friendliness.” Chrysler and NHTSA have enforced our ignorance about Cassidy.

Paul V. Sheridan
DDM Consulting
22357 Columbia Street
Dearborn, MI 48124-3431
313-277-5095
pvs6@cornell.edu

CONFIDENTIAL

PE10-031

Chrysler

10-15-2010

Enclosure 6E

Jarmon Report

ATTACHMENT 4

Mr. Clarence Ditlow, Director
Center for Auto Safety
Suite 330
1825 Connecticut Ave, NW
Washington, DC 20009-5708
(202) 328-7700

20 August 2014

Subject: Proposal for Criminal Investigation of Chrysler, and Senatorial review of NHTSA EA12-005

Reference 1: Senator Claire McCaskill, Senate Subcommittee on Consumer Protection/Product Safety

Reference 2: Criminal Manslaughter Indictments Filed Involving Fire-Death in EA12-005 Jeep

Four Pages

W A R N I N G : The following four photographs are very graphic. These depict what happens to victims of EA12-005 Jeeps when involved in foreseeable, low and medium speed rear impacts.

Memo: A trailer hitch would not have protected Mrs. Kline.

Paul V. Sheridan
DDM Consulting
22357 Columbia Street
Dearborn, MI 48124-3431
313-277-5095
pvs6@cornell.edu



BROTHERHOOD
OF
THIEVES

Mrs. Susan Kline with her family.

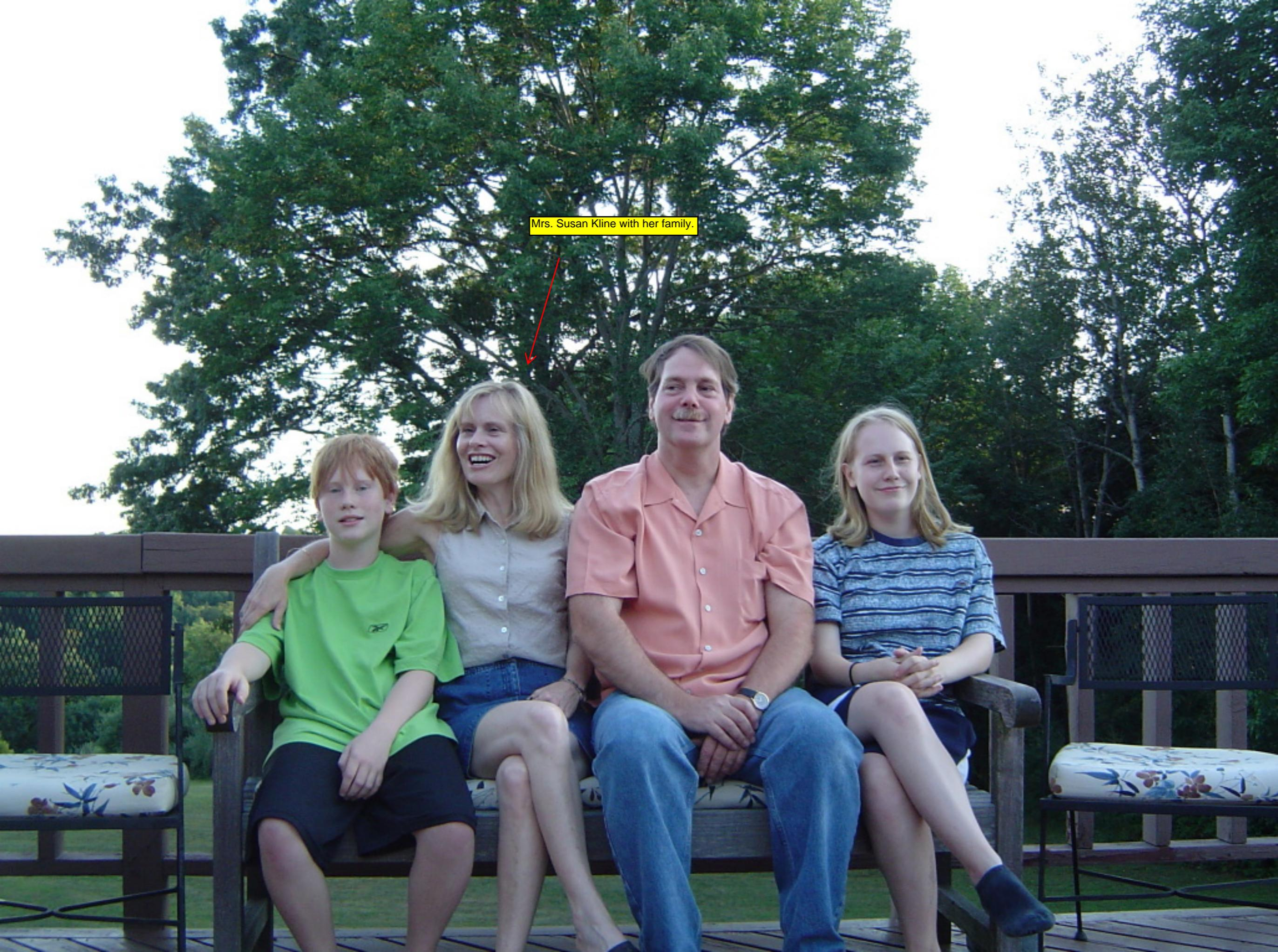



Skull

Jaw Bone

Mrs. Susan Kline (death victim).
Post fuel-fed fire caused by defective fuel system/tank
design in Jeep Grand Cherokee SUVs

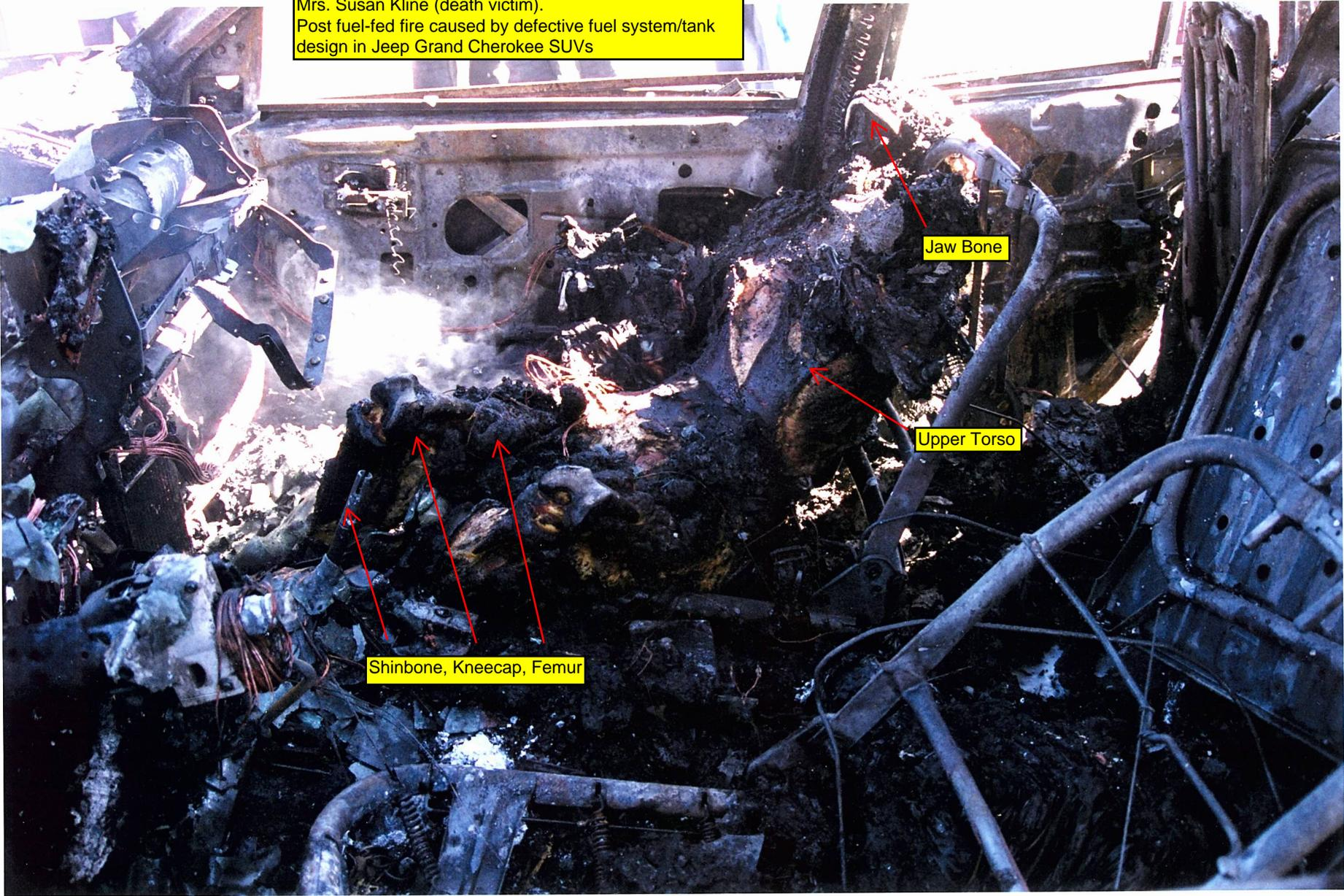

Jaw Bone

Upper Torso

Shinbone, Kneecap, Femur

ATTACHMENT 5

Mr. Clarence Ditlow, Director
Center for Auto Safety
Suite 330
1825 Connecticut Ave, NW
Washington, DC 20009-5708
(202) 328-7700

20 August 2014

Subject: Proposal for Criminal Investigation of Chrysler, and Senatorial review of NHTSA EA12-005

Reference 1: Senator Claire McCaskill, Senate Subcommittee on Consumer Protection/Product Safety

Reference 2: Criminal Manslaughter Indictments Filed Involving Fire-Death in EA12-005 Jeep

Three Pages

In his indictment of Rafael Perez Jr. and Joel Nieves-Cruz, to a Massachusetts grand jury, Assistant District Attorney James Forsyth declares:

“The defendant(s) herein, of Springfield in the County of Hampton, on or about November 10, 2013, at HAMPTON COUNTY, did assault and beat Skyler Anderson-Coughlin, and by such assault and beating did kill said Skyler Anderson-Coughlin.

Specifically, (defendants), on or about November 10, 2013, having a legal duty of care, did engage in wanton and reckless conduct, and by such conduct did cause the death of Skyler Anderson-Coughlin in violation of General Laws chapter 265 section 13.

Paul V. Sheridan
DDM Consulting
22357 Columbia Street
Dearborn, MI 48124-3431
313-277-5095
pvs6@cornell.edu

COMMONWEALTH
VS.
JOEL NIEVES-CRUZ

14 675 -1

**INDICTMENT
INVOLUNTARY MANSLAUGHTER
GENERAL LAWS CHAPTER 265, SECTION 13**

At the Superior Court, begun and holden at Springfield, within and for the County of Hampden, on the first Tuesday of June 2014. The GRAND JURORS for the Commonwealth of Massachusetts on their oath present that:

JOEL NIEVES-CRUZ

defendant herein, of Springfield in the County of Hampden, on or about November 10, 2013 at HAMPDEN COUNTY, did assault and beat Skyler Anderson-Coughlin, and by such assault and beating did kill said Skyler Anderson-Coughlin.

Specifically, that Joel Nieves-Cruz on or about November 10, 2013, having a legal duty of care, did engage in wanton and reckless conduct, and by such conduct did cause the death of Skyler Anderson-Coughlin, in violation of General Laws chapter 265, section 13.

A TRUE BILL

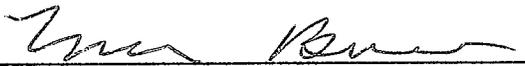

Foreperson of the Grand Jury

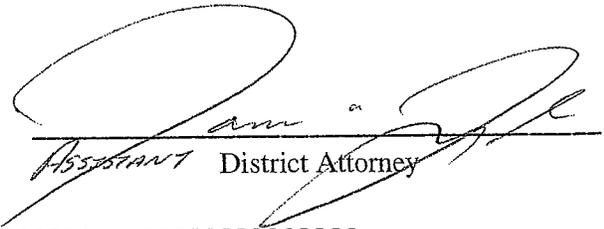

Assistant District Attorney

RETURN

HAMPDEN, ss On this 26th day of June, 2014, this indictment was returned and presented to said Superior Court by the Grand Jury, and ordered to be filed and filed.

ATTEST:

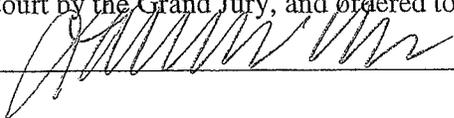

Assistant Clerk

COMMONWEALTH

VS.

JOEL NIEVES-CRUZ

14 875-2

INDICTMENT

LEAVING THE SCENE OF A DEATH

GENERAL LAWS CHAPTER 90, SECTION 24(2)(a1/2)(2)

At the Superior Court, begun and holden at Springfield, within and for the County of Hampden, on the first Tuesday of June 2014. The GRAND JURORS for the Commonwealth of Massachusetts on their oath present that:

JOEL NIEVES-CRUZ

defendant herein, of Springfield in the County of Hampden, on or about November 10, 2013 at HAMPDEN COUNTY, did operate a motor vehicle upon a way or in a place to which the public has a right of access or upon a way or in a place to which members of the public shall have access as invitees or licensees and without stopping and making known his name, residence and the registration number of his motor vehicle, did go away to avoid prosecution or evade apprehension after knowingly colliding with or otherwise causing injury to any person, the result of which caused the death of Skyler Anderson-Coughlin, in violation of General Laws chapter 90, section 24(2)(a 1/2)(2).

A TRUE BILL

Foreperson of the Grand Jury

Assistant District Attorney

.....

RETURN

HAMPDEN, ss On this 26th day of June, 2014, this indictment was returned and presented to said Superior Court by the Grand Jury, and ordered to be filed and filed.

ATTEST:

Assistant Clerk

COMMONWEALTH
VS.
RAFAEL PEREZ, JR.

14 676-1

INDICTMENT
INVOLUNTARY MANSLAUGHTER
GENERAL LAWS CHAPTER 265, SECTION 13

At the Superior Court, begun and holden at Springfield, within and for the County of Hampden, on the first Tuesday of June 2014. The GRAND JURORS for the Commonwealth of Massachusetts on their oath present that:

RAFAEL PEREZ, JR.

defendant herein, of Springfield in the County of Hampden, on or about November 10, 2013 at HAMPDEN COUNTY, did assault and beat Skyler Anderson-Coughlin, and by such assault and beating did kill said Skyler Anderson-Coughlin.

Specifically, that Rafael Perez, Jr. on or about November 10, 2013, having a legal duty of care, did engage in wanton and reckless conduct, and by such conduct did cause the death of Skyler Anderson-Coughlin, in violation of General Laws chapter 265, section 13.

A TRUE BILL



Foreperson of the Grand Jury

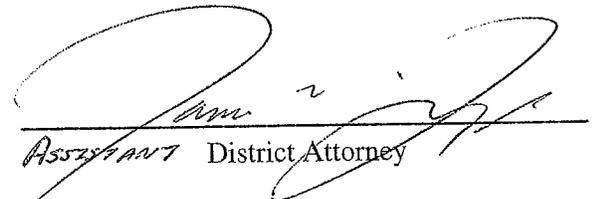

Assistant District Attorney

RETURN

HAMPDEN, ss On this 26th day of June, 2014, this indictment was returned and presented to said Superior Court by the Grand Jury, and ordered to be filed and filed.

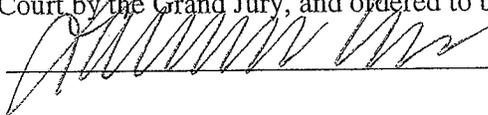
ATTEST: 

Assistant Clerk



Rafael Perez Jr., Joel Nieves Cruz deny manslaughter charge in fatal Longmeadow crash

Rafael Perez Jr., left and Joel Nieves Cruz, right arrive in Hampden County Superior Courtroom 1 Wednesday for their arraignment on a manslaughter charge. (MARK M.MURRAY / THE REPUBLICAN) *(Mark Murray)*

Buffy Spencer | bspencer@repub.com By **Buffy Spencer** | bspencer@repub.com

Email the author

on July 09, 2014 at 11:14 AM, updated July 09, 2014 at 1:19 PM

SPRINGFIELD - **Two city men** who ran onto Interstate 91 last November to get couch cushions that fell from their pickup truck denied a manslaughter charge Wednesday in **Hampden Superior Court**.

Joel Nieves Cruz, 32, of 76 Oswego St.; and Rafael Perez Jr., 43, of 32 Acushnet Ave. are charged in the death of 17-year-old Skyler Anderson-Coughlin of Springfield.

Anderson-Coughlin was driving a Jeep and swerved to avoid the situation created by the men in the road, Assistant District Attorney James M. Forsyth said. He said other vehicles were stopping or swerving to avoid the men retrieving the cushions.

A collision between the Jeep driven by Anderson-Coughlin and a tractor trailer truck caused a fiery crash about 6 p.m. Nov. 10. Anderson-Coughlin was alone in the Jeep.

Both men were released on their own recognizance by Judge Mary Lou Rup on the recommendation of the prosecutor. They had come to court for arraignment in response to a summons.

Cruz is represented by Roy Anderson and Perez by Marissa Elkins.

Several family members of the victim were in the courtroom with victim witness advocate Margo Piela.

Cruz was driving the pickup truck and is also charged with leaving the scene of a personal injury or death accident. Perez owned the truck and was a passenger, Forsyth said.

The crash happened in Longmeadow in the northbound lanes.

Anderson-Coughlin was a student at McDuffie School in Granby. A candlelight vigil was held there Nov. 15.

The manslaughter charge cites wanton and reckless conduct.

© 2014 masslive.com. All rights reserved.

END OF DOCUMENT

20 August 2014

Mr. Clarence Ditlow, Director
Center for Auto Safety
Suite 330
1825 Connecticut Ave, NW
Washington, DC 20009-5708
202-328-7700

Subject: Proposal for Criminal Investigation of Chrysler, and Senatorial review of NHTSA EA12-005

Reference 1: Senator Claire McCaskill, Senate Subcommittee on Consumer Protection/Product Safety

Reference 2: Criminal Manslaughter Indictments Filed Involving Fire-Death in EA12-005 Jeep

Paul V. Sheridan
DDM Consulting
22357 Columbia Street
Dearborn, MI 48124-3431
313-277-5095
pvs6@cornell.edu

ATTACHMENT 5

29 April 2015

Attorney General Kamala D. Harris
Office of the Attorney General
1300 "I" Street
Sacramento, CA 95814-2919
916-445-9555

Subject: Criminal Investigation of those Responsible for Severe Injury to the Sanchez Brothers
Ref: Conspiratorial Closure of NHTSA EA12-005: Jeep Fuel System Crashworthiness Defect

Forty-Three Pages

Letter sent to Michigan Attorney General Bill Schuette received 24 April 2015. The Sanchez Brothers are discussed on Page 3.

As a primer for the Subject, please review Pages 13 and 14 of this Attachment 5.



April 24,2015

Dear Customer:

The following is the proof-of-delivery for tracking number **800793416009**.

Delivery Information:

Status:	Delivered	Delivered to:	Mailroom
Signed for by:	C.FARR	Delivery location:	525 W OTTAWA ST MI 48909
Service type:	FedEx Standard Overnight	Delivery date:	Apr 24, 2015 09:37
Special Handling:	Deliver Weekday		



Shipping Information:

Tracking number:	800793416009	Ship date:	Apr 23, 2015
		Weight:	0.5 lbs/0.2 kg

Recipient:

A G BILL SCHUEETE
G MENNEN WILLIAM BLDG 7TH FLR
525 WEST OTTAWA ST
MI 48909 US

Reference

Shipper:

PAUL V. SHERIDAN
SHERIDAN, PAUL V
22357 COLUMBIA ST
DEARBORN, MI 481243431 US

KAYLA WHITE

Thank you for choosing FedEx.

DDM Consulting
22357 Columbia Street
Dearborn, MI 48124-3431
313-277-5095
pvs6@Cornell.edu

23 April 2015

VIA FEDEX AIRBILL 8007 – 9341 - 6009

Attorney General Bill Schuette
7th Floor
G. Mennen Williams Building
525 W. Ottawa Street
Lansing, MI 48909
517- 373-1110

Subject: Criminal Investigation of those Responsible for the Manslaughter of Ms. Kayla White
Reference: Conspiratorial Closure of NHTSA EA12-005: Jeep Fuel System Crashworthiness Defect

Courtesy Copy List *

Ms. Susan L. White
2858 Horton Street
Ferndale, MI 48220
248-548-3557

Governor Rick Snyder
111 South Capitol Avenue
Lansing, MI 48933
517-373-3400

Ms. Jessica R. Cooper
Oakland County Prosecutor
West Wing - Building 14E
1200 North Telegraph Road
Pontiac, MI 48341-0461
248-858-0656

Dr. Mark R. Rosekind
Administrator
NHTSA Headquarters
1200 New Jersey Avenue, SE
Washington, DC 20590
202-366-4000

Mr. Clarence Ditlow, Director
Center for Auto Safety - Suite 330
1825 Connecticut Ave, NW
Washington, DC 20009-5708
(202) 328-7700

Mr. Courtney E. Morgan, Jr.
Morgan & Meyers, PLLC / Suite 320
3200 Greenfield Road
Dearborn, MI 48120
313-961-0130

* *By email and/or USPS*

** Up-to-date PDF version available with active hyperlinks :

<http://pvsheridan.com/Sheridan2Schuette-1-23April2015.pdf>

DDM Consulting
 22357 Columbia Street
 Dearborn, MI 48124-3431
 313-277-5095
pvs6@Cornell.edu

23 April 2015

VIA FEDEX AIRBILL 8007 – 9341 - 6009

Attorney General Bill Schuette
 7th Floor
 G. Mennen Williams Building
 525 W. Ottawa Street
 Lansing, MI 48909
 517- 373-1110

Subject: Criminal Investigation of those Responsible for the Manslaughter of Ms. Kayla White
Reference: Conspiratorial Closure of NHTSA EA12-005: Jeep Fuel System Crashworthiness Defect

Table of Contents	
Perspective for Subject : 1% versus the 99%	Page 1
<i>Review of Some Primary Victims of the Jeep Fuel System Crashworthiness Defect</i>	<i>Pages 2 - 4</i>
The Jeep Fuel Tank Crashworthiness Defect : A History Based in Criminality	Pages 5 - 6
<i>The Alternative Design : The 2005 WK-Body Jeep Grand Cherokee – Rejected in 1987</i>	<i>Pages 7 - 8</i>
Mercedes-Benz WK-Body : The Zero Fire-Deaths Architecture of “Midshipment” (sic)	Pages 9 - 10
<i>Fundamental FCA Lie – Part One : “Ultra High Energy – Ultra High Speed Crash”</i>	<i>Page 11</i>
Fundamental FCA Lie – Part Two : “The Jeeps Meet or Exceed all Government Safety Standards and have an Excellent Safety Record ”	Page 12
<i>Intermission : A Brief Summary of the Sections Above</i>	<i>Pages 13 - 14</i>
Criminal Conspiratorial Closure of NHTSA EA12-005: Jeep Fuel System Crashworthiness Defect	Page 15
<i>Conspiratorial Closure of NHTSA EA12-005 : The MOPAR “Trailer Hitch Remedy” Fraud</i>	<i>Pages 16 - 24</i>
Conspiratorial Closure of NHTSA EA12-005 : Cover-up by the “Honorable” DOT Inspector General	Page 25
<i>Criminal Investigation of those Responsible for the Manslaughter of Ms. Kayla Lucille White</i>	<i>Pages 26 - 29</i>
ENDNOTES - Hyperlinks	Pages 31 – 32
<i>Paul V. Sheridan letters - Jeep fuel tank crashworthiness defect investigation - Hyperlinks</i>	<i>Page 33</i>

DDM Consulting
22357 Columbia Street
Dearborn, MI 48124-3431
313-277-5095
pvs6@Cornell.edu

23 April 2015

Via FedEx Airbill 8007 – 9341 – 6009

Attorney General Bill Schuette
G. Mennen Williams Building, 7th Floor
525 W. Ottawa Street
Lansing, MI 48909
517- 373-1110

Subject: Criminal Investigation of those Responsible for the Manslaughter of Ms. Kayla White
Reference: Conspiratorial Closure of NHTSA EA12-005: Jeep Fuel System Crashworthiness Defect

Dear Mr. Schuette:

The 'Public Integrity' tab of the Michigan Attorney General website states :

"February 2011, Attorney General Schuette created a new Public Integrity Unit to ramp up the fight against corruption in state and local government, protect tax dollars and restore the public's trust in government." ^A

At the Biography tab of the website, the following is stated about you:

"From his father, mother and stepfather, Bill learned the basic Michigan values of honesty, hard work, the importance of your word, strength of family and the need to give back to your community." ^B

With these as partial context, it would be prudent not to interpret what follows as emotional, or diatribe, an exaggeration, or strident. Given the gravity of the subject, such an interpretation would strain these quotes.

Perspective for Subject : 1% versus the 99%

Picture the following results from a prosecution that your office rendered:

The horrific death of a 4-year-old child results in the conviction of the two parties responsible. The jury is instructed to assign proportional responsibility.

The first party openly and honestly admits both guilt and partial responsibility for the manslaughter. Although the jury assesses a proportion of only 1%, this first party is sentenced to a 7-year prison term.

Despite overwhelming culpatory evidence, the second party denies any guilt and refuses responsibility. Indeed the evidence is so convincing that the jury assesses a proportion for this second party of 99%. But the judicial system sets the 99% party free, to enjoy life, limb and luxury.

The facts just presented are not based on fiction. Nor is the basis merely a civil matter. Only the uninformed, or knowledgeable but corrupt and servile, would deny that the Subject is appropriate.

That the Subject is criminal is clarified with a brief introduction to *some* of the victims of Reference 1. The victims are two-fold. The secondary victim is 1% guilty. Some of the primary victims are discussed next. But in the final analysis, even the 1% are innocent when compared to the torrid history of the 99%.

Review of Some Primary Victims of the Jeep Fuel System Crashworthiness Defect

The driver who caused the collision on a quiet Georgia street on March 6, 2012 did so as a result of a momentary lapse of attentiveness. But the group that caused the fire that killed 4-year-old Remington Walden did so as a result of decades of criminal activity. This incident and related historical reality was the basis of the jury assignments of 1% and 99% respectively. ^C



The driver, to whom the jury assigned a fault of only 1%, owned the collision. He now has a criminal record. Remington survived the collision, but Fiat-Chrysler Automobiles (FCA), at a fault of 99%, owned the fire the killed him. ^D The autopsy proved that fact. But FCA remains free to enjoy life, limb and luxury. ^E

A similar scenario is facing the Skyler Anderson-Coughlin family. Two men who allegedly caused the collision in Massachusetts on November 10, 2013 had a momentary lapse of judgment. But FCA caused the fire that killed 17-year-old Skyler; the result of decades of criminal activity.



The two men are facing criminal prosecution. Seventeen-year-old Skyler survived the collision, but FCA, the group that owns the fire, is free to enjoy life, limb and luxury. ^F

A similar scenario is facing the family of Ana Pina. The person who caused the collision on an Indiana highway on January 14, 2012 was inattentiveness . . . ordinarily just a civil matter. The group that caused the fire, that horribly burned Ana, did so as a result of decades of criminal activity.



The driver that collided with the rear of Ana's Jeep Cherokee admitted guilt, and is facing criminal prosecution. Ana survived the collision, as did EVERYONE else, but FCA, the group that **owns the fire**, denies responsibility, faces no criminal prosecution, and is free to enjoy life, limb and luxury.

A similar scenario faces the Sanchez brothers, Magdaleno and Raymundo. The lady who caused the collision in California on April 5, 2014, had a momentary lapse of judgment. The group that caused the fire, that horribly burned *both* Magdaleno and Raymundo, did so as a result of decades of criminal activity.



The driver of the Honda who caused the collision admitted guilt, took responsibility, and is facing criminal prosecution. But FCA, the group that **owns the fire**, denies any responsibility, and claims that the Jeep, which caused the raging inferno shown above, contains no safety defect. FCA claims the Jeep "*met or exceeded all government standards.*" FCA remains free to enjoy life, limb and luxury.

The case that faced the family of Susan Kline was anything but simplistic. I am the person that informed the Center for Auto Safety (CAS) of the horrific fire-death of a 49-year-old mother and wife. This information further catalyzed their Defect Petition that led the National Highway Traffic Safety Administration (NHTSA) to commence defect investigation EA12-005 ^G

Eyewitnesses confirmed that Susan survived the collision but burned to death in a Jeep Grand Cherokee:

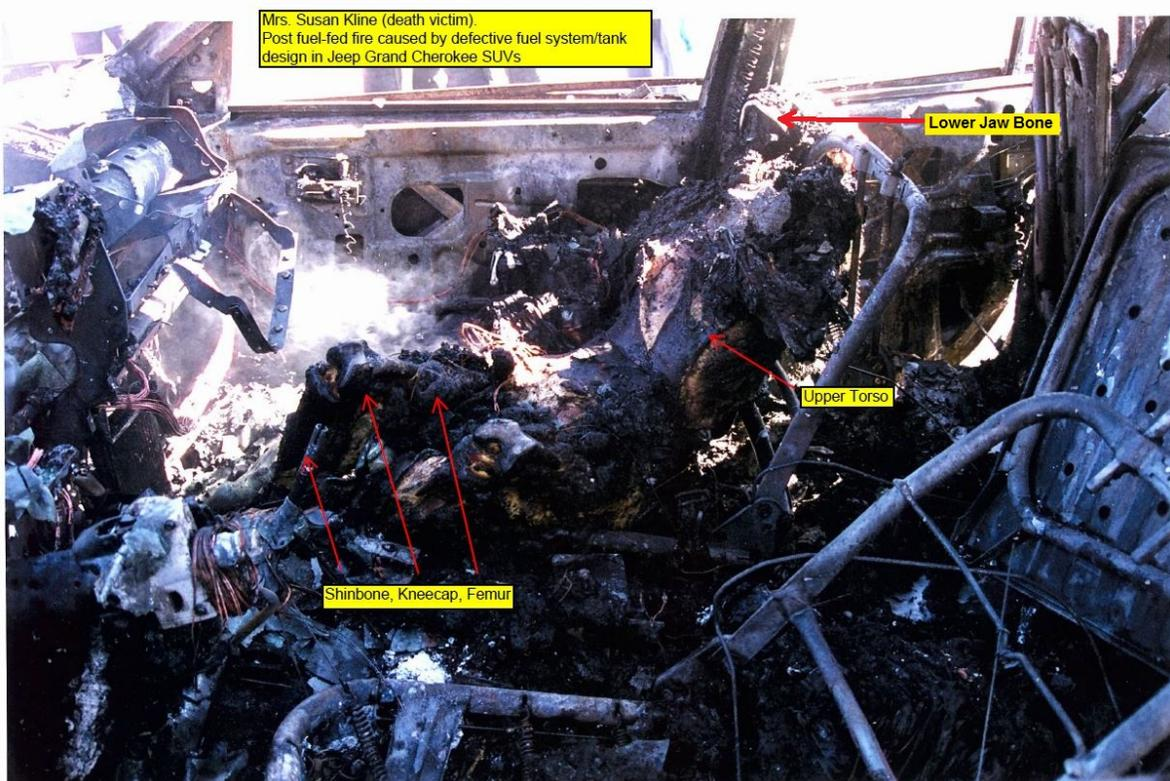
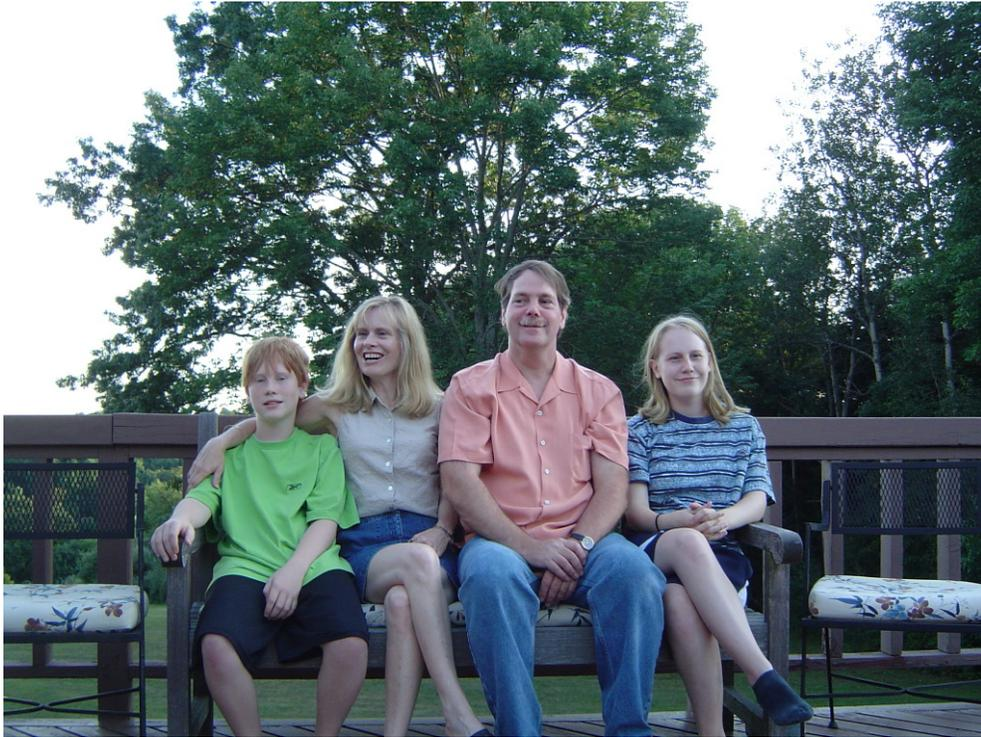

The Jeep Fuel Tank Crashworthiness Defect : A History Based in Criminality

Contrary to the PR deployed by FCA in defense of the Kline litigation, the essence of the events that burned Susan to death on February 24, 2007 is captured by the words of an eyewitness ^H

“The back of the Jeep immediately burst into flames upon impact. I drove through the debris and fireball caused by the Jeep exploding.”

A former FCA employee, a man of experience and integrity, Mr. Robert Banta testified (for the defendant) regarding a photograph that CAS and I supplied to attorney Angel Defilippo; a photograph that depicts the exact configuration of the Susan Kline Jeep:

DeFilippo: Now, in looking at that photo, can you tell me what part of the vehicle protects the part of the tank that we’re looking at in that photograph?

Banta: *No. It’s covered by the fascia.*

DeFilippo: So if a vehicle were to strike just that **yellow piece of the car**, whether it be because it’s lower or some kind of vehicle that’s not even a car, let’s say it was a recreational vehicle of some sort, what would protect that portion of the tank that we see here in **yellow**.

Banta: *Just the tank surface itself.*

DeFilippo: So in other words, whatever the material of the tank is at the time?

Banta: ***The tank’s on its own.*** ^I



The woman who collided with the Kline Jeep in New Jersey had a momentary lapse of attentiveness. She faced charges and a criminal record.

The autopsy confirms that Susan survived the collision but died in a sequence of events straight from Hell.

FCA, the group that **owns the “fireball caused by the exploding Jeep,”** denied that *“the tank’s on its own,”* asserts that *“the yellow piece of the car”* is crashworthy . . . and is free to enjoy life, limb, and luxury.

Related to Jeep crashworthiness is the person FCA calls “*The Father of the Jeeps.*”^J

Francois Castaing was the Vice President of Jeep and (Dodge) Truck Engineering, JTE^K I worked for Castaing for four years as an Engineering Programs Manager. I presented numerous technical and vehicle program reports directly to him. These reports included everything from diesel engine programs to Dodge truck engineering design, such as the N-Body^L



Later Castaing became Executive Vice President of Engineering and the Product Executive directly responsible for all Jeep programs^M In litigation involving a Jeep designed by Castaing, attorney Larry Coben examined his knowledge of Jeep crashworthiness:

Coben: What does the term crashworthiness mean in terms of design of a product?

Castaing: *I don't know. Tell me.*

Coben: You don't know the phrase?!

Castaing: *No.*

Coben: Well, let me make sure I'm clear on this. As the chief engineer of the company, are you at all familiar with the use of the phrase crashworthiness by the engineers of the company?

Castaing: ***Crashworthiness is so vague that you have to tell me what you intend by that.***^N

The jury in the fire-death case of Remington Walden noticed that the “*Father of the Jeep,*” the executive who was directly responsible for the original product plan and engineering design of the 1999 Jeep Grand Cherokee, failed to raise his right hand and defend *his* designs^O

The Alternative Design : The 2005 WK-Body Jeep Grand Cherokee – Rejected in 1987

In fact, the only time that Castaing attempts to defend his Jeep crashworthiness is when compelled by subpoena. In the fire-death litigation of Susan Kline, Castaing's historical contribution to the Subject was put on the record by plaintiff attorney Courtney Morgan.

When deposed on June 14, 2012, Castaing testified on a proposal to revise the underlying engineering design of the Jeep Sport Utility Vehicles (SUV). A well-known and implicit aspect of the proposal (which specified a platform called the N-Body) included fuel tank location:

Morgan: Now earlier, Mr. Castaing, you testified that the ZJ was mostly complete when the merger between AMC and Chrysler took place, and at that time, you learned that Chrysler was working on an SUV of their own, and Chrysler learned you were working on the ZJ, the Grand Cherokee. Have I got it right?

Castaing: Yes.

Morgan: And you said there was a delay and so forth. One thing I was a little unclear on. The Chrysler or the Dodge SUV, did it go forward, did it not go forward?

Castaing: *It didn't.*

Morgan: Okay. And do you know that that -- can you tell me, are you familiar with something called the N-body?

Castaing: *Yeah, the N-body, I think, was the pickup truck, the small pickup truck for Chrysler.*

Morgan: And was the N-body the basis of the SUV that Chrysler and Dodge were in the process of putting together when the two companies merged and then that got shelved?

Castaing: *I think so. I'm not sure but I think so.*

Morgan: Okay, okay. And can you tell me, sir, with respect to that Dodge SUV based on the N-body, where was the fuel tank anticipated to be mounted, if you know?

Castaing: *No, I don't.*

Morgan: Okay. Did you participate in meetings that led to the cancellation of the Dodge-based SUV and the elevation or the decision to do the Grand Cherokee?

Castaing: Yes.

Castaing's claim of ignorance regarding the location of the N-Body fuel tank is tantamount to him claiming ignorance regarding the location of Europe.

In truth, he was fully aware that the mid-mounted fuel tank was a central benefit of the proposal to revise the underlying Jeep engineering design to the N-Body. I can assure you that Castaing was intimately involved in every aspect of the detailed discussions that threatened cancellation of **his** "ZJ-Body" These types of decisions involve the highest levels of corporate management.

Why am I certain of this truth? I was the Engineering Program Manager that formally proposed the N-Body design for the Jeep. I was assigned to the N-Body after "the merger between AMC and Chrysler took place" in 1987. As such, it was my job to advocate the N-Body design. ^P

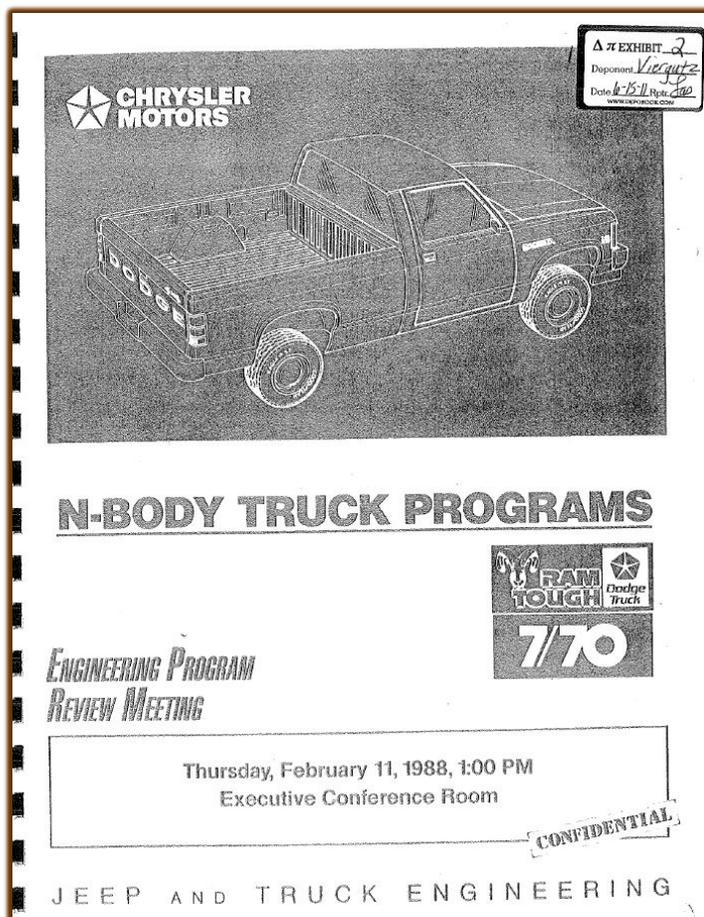
The Alternative Design : The 2005 WK-Body Jeep Grand Cherokee – Rejected in 1987 - con't

Castaing, as head of JTE, was also aware-of and in receipt-of a Chrysler document that predated the N-Body by ten years. He was in-receipt of the document prior to his rejection of the proposal to revise the Jeep Grand Cherokee to the N-Body. ^Q

In my Press Release on Walden, I detail how public release of the **Baker memo** occurred, and the abuse of trust that followed. ^R

The crashworthiness improvement of the mid-mount location of the N-Body fuel tank was consistent with the urgencies summarized by Mr. Baker in 1978. ^S

Not summarized is how this history relates to a 2005 Jeep vehicle that was NOT designed by FCA, is virtually indistinguishable from the N-Body regarding fuel tank location, and has a zero fire-death history.

Below the ENDNOTES you will find links to the 23 letters I have written regarding the 'Jeep Fuel Tank Crashworthiness Defect.' The Butler-Wooten firm, that adjudicated the recent \$150,000,000.00 verdict in Walden vs FCA, received my letters.

After NHTSA commenced EA12-005, my letters were a resource for the plaintiffs, especially regarding the details of the 2005 Jeep Grand Cherokee, coded WK-Body, a design anticipated by the Baker Memo.

Prior to the \$150,000,000.00 verdict in Georgia, FCA made the claim for media consumption:

“Chrysler moved the tank in 2005.”

Chrysler did no such thing. The media also reported a Chrysler claim that they had *“moved the tank to make more room for luggage space.”* A preposterous lie. In truth, what Chrysler pursued was outrageous, but characteristic of the incompetence and greed that led to the 'Jeep Fuel Tank Crashworthiness Defect.'

Rather than submitting to the basic physical realities which suggested that relocating the fuel tank should have commenced not later than 1993, Chrysler persisted in their ZJ architecture, pursuing a farce called *“the cage”* ^T I am not being picayune; these details are important and, as we will see, relate to perjurious testimony in the Kline litigation.

With my letters and the “cage” as context, Butler-Wooten attorneys requested all documents regarding the decision to relocate the fuel tank from the rear to mid-mount in the 2005 WK-Body Jeep Grand Cherokee. Astoundingly, FCA claimed they had no documents responsive to that discovery. Destruction of this type of evidence, documents that would have confirmed the fuel tank location similarities between the 1987 N-Body program and the 2005 WK-Body, is by-itself a crime. ^U

Mercedes-Benz WK-Body : The Zero Fire-Deaths Architecture of “Midshipment” (sic)

Throughout the Susan Kline litigation FCA witnesses testified that the decision on the fuel tank location was made by an internal group called “packaging,” In this contrived scenario, we are supposed to believe that an as-yet unidentified draftsman made the crucial decision to locate the fuel tank in the rear. In my opinion, this ruse resulted in-part from defense lawyer coaching. But the fact is, this sputum is not a testimonial mistake or a misstatement: **it is perjury.**

After the illegal destruction of documents, that related to the decision to locate the 2005 Jeep fuel tank to mid-mount, FCA instead offered the Chief Engineer of the WK-Body, Mr. Philip Cousino. On January 23, 2015 Cousino was deposed by Walden family attorney Jeb Butler:

Butler: You're an engineer, right?

Cousino: *I'm an engineer.*

Butler: You were chief engineer for the Grand Cherokee with midships fuel tank, correct?

Cousino: *I was the chief engineer of the program in March of 2003. I was not involved in the architecture of the vehicle, which would have happened in 2001 and probably a little bit in 2002. The architecture was -- the architecture of -- when a vehicle goes -- goes into production, it starts as an idea, it goes into prepackaging, it goes into a design office mode. Architecture is developed, the architecture is where do you place everything. Those things were already done -- done when I became chief engineer. In fact, we were already into a pilot build phase for the first vehicles.*

Butler: So the first time you were a chief engineer for any Grand Cherokee was March or April of 2003, correct?

Cousino: *Correct.*

Butler: And at that time the decision had already been made to move the gas tank away from the rear and put it in the midships location, correct?

Cousino; *The decision was made to put it in midship.*

Butler: Is that right, is the answer yes?

Cousino: *At that moment we were -- we were part of Mercedes-Benz, our CEO and COO were involved in the design and architecture of that vehicle, and Mercedes had their fuel tanks at midship so they were instrumental and I assume -- I assume because they were involved -- that's who's involved in a design office architecture of the vehicle is fairly high levels of people at the company that because of their involvement and ownership of our company, they were instrumental in making it **midshipment** (sic), just as it was from Mercedes.*

Throughout his testimony, Mr. Cousino emphasizes a rudimentary and historically well-known fact of auto design: “Architecture” is a broad, overall vehicle design decision that is made by the highest levels of an auto company. This is consistent with the Francois Castaing testimony regarding his participation in the Chrysler executive management decision to retain the rear-mounted fuel tank on his ZJ-Body, while rejecting my 1987 proposal to base the then-new 1993 Jeep Grand Cherokee on the N-Body.

The sworn testimony of Mr. Cousino continues:

Butler: Oh, when you became chief engineer for the 2005 model year Grand Cherokee in March or April of 2003 the decision had already been made to move the gas tank away from the rear and put it in the midships location, correct?

Cousino: *If you're saying move as if it's the same vehicle, it was a brand-new vehicle, so from the design of the brand-new vehicle, it was designed in as a midship tank. It wasn't moved, it was designed that way. It's a brand-new architecture, brand-new vehicle, brand-new systems.*

Butler: Isn't it true that the 1999 Grand Cherokee had a gas tank at the rear?

Cousino: Yes.

Butler: Isn't it true that the 2005 model year Grand Cherokee had the gas tank midships?

Cousino: Yes.

Butler: All right. Now, you said in one of your answers previously that the architecture of the vehicle starts as an idea. Whose idea was it to put the gas tank in the midships location rather than at the rear?

Cousino: *I don't know. I think in talking to -- because I wasn't part of the program, I think in talking to the chassis engineering director, whose name is Denny Moothart, who is -- who is deceased, that he mentioned that Dieter Zetsche and Wolfgang Bernhard, who were the CEO and COO of the company, both from Mercedes, were involved in that decision.*



Butler: Do you know who made the decision?

Cousino: *No, I do not.*

Butler: But you did say in a prior answer that Mercedes-Benz was instrumental in moving the gas tank away from the rear; do you remember saying that?

Cousino: *Uh-huh. Oh, yes.* ^v

Fundamental FCA Lie – Part One : “Ultra High Energy – Ultra High Speed Crash”

Picture the following crash test realities:

A full size passenger vehicle collides into the rear of a Sport Utility Vehicle with a difference in speed of 70 miles per hour . . . but there are no fuel leaks, and there is no fire.

A full size passenger vehicle collides into the rear of a Sport Utility Vehicle with a difference in speed of 75 miles per hour . . . but there are no fuel leaks, and there is no fire.

A full size passenger vehicle collides into the rear of a full size passenger vehicle with a difference in speed approaching 80 miles per hour . . . but there are no fuel leaks, and there is no fire.

FCA is fully aware of these facts. Their claim that the primary victims in Jeep crashes were injured or killed as a result of an “*ultra high energy, ultra high speed crash*” is known by them to be fraudulent.

Defrauding the public regarding their safety & well-being, blatantly misleading them, relying on their (literal) ignorance and naiveté, is what constitutes just one of the crimes committed by FCA.

FCA and NHTSA/DOT continue to defraud the public; both are aware-of and in possession-of these and many other crash test facts. Both FCA and NHTSA/DOT are aware of the CAS webpage. ^W

FCA and NHTSA/DOT know that the defective Jeeps cannot sustain low energy, low speed crashes without placing the occupants at risk of fire-death or fire-injury. Both are aware of the Kenneth Smith case which occurred in 2001, and had a speed difference of only 25 miles per hour! They are aware that in each case discussed above, all of the primary victims survived the initial crash with no or little injury.

Let us emphasize the viciousness of the FCA lie relating to “*ultra high energy, ultra high speed crash.*” I investigated the fire-death horror in Orlando, Florida of November 16, 2011. I contacted the individual that filmed the following real-time video. It was immediately uploaded to my YouTube which is visited by FCA and NHTSA/DOT. In the next link @2:20, an eye and ear witness statement is exclaimed:



“Oh my God . . . I hear screaming.”

<https://www.youtube.com/watch?v=gQp6MG7w--s#>

FCA and their subordinates at NHTSA/DOT are fully aware that a **victim that has been killed upon impact, presuming an “ultra high energy, ultra high speed crash,” is not capable of screaming.** ^X

Fundamental FCA Lie – Part Two : “The Jeeps Meet or Exceed all Government Safety Standards and have an Excellent Safety Record ”

These most certainly do not, and at both levels. With this PR rhetoric, which also permeates their defense tactics, FCA is attempting to subvert the concept of auto safety to the legalistic, the bureaucratic; and worse, merely the statistical. The particular ‘safety standard’ in focus is FMVSS-301. The most succinct, lucid assessment of 301 comes from the Center for Auto Safety Director, Mr. Clarence Ditlow:

“Even the Pinto passed 301!”

Two years before their “Chicago deal” (reviewed below), NHTSA Administrator David Strickland and FCA Chairman Sergio Marchionne received letters that detail my approach as a former Chrysler safety manager. The “Chicago deal” participants have no such experience. Entitled ‘*Correct Statistical Approach to NHTSA Defect Investigation EA-12-005.*’, my letter states:

“As chairman of the Chrysler Safety Leadership Team (SLT), my priority involved Failure Mode Effects Analysis (FMEA) as the basis of preliminary and ongoing examination of a safety concern. In my role it did not matter that only one person may be affected during vehicle service life. What mattered was that a failure mode existed, and when provoked would cause serious harm.

Hypothetically, the fact that a vehicle service life was statistically “lucky,” and a failure mode was provoked “only once,” was not gala. Such an approach would merely confirm incompetence as a safety manager. For perspective, I have testified in litigation wherein defense counsel has deployed two themes:

- 1) “compliance with all government safety standards” and
- 2) various NHTSA statistics.

*However, when the jury in Jimenez v Chrysler learned of the latter’s foreknowledge that FMVSS-206 failed to address the failure mode that was responsible for the death of an 8-year-old boy, **that standard and related NHTSA statistics were rendered legally and morally worthless.***

*Similarly, when the jury in Flax v Chrysler learned that FMVSS-207 did not address **the failure mode that was responsible for the death of an infant, that standard and related statistics were deemed irrelevant.**”*

As FCA and NHTSA/DOT are fully aware, the primary ‘failure mode’ that is not addressed by FMVSS-301, in relation to the Jeep fuel system safety defect, is the underride collision. This rudimentary fact is central to the Subject, the manslaughter of Ms. Kayla Lucille White and her unborn son Braedin.

It is well-known to FCA/NHTSA/DOT that proclamations of complying with the minimums of a ‘safety standard’ may be effective when misleading the public or the courts, but such has only tentative connection to real world safety. Every jury that has heard my testimony on these points agrees. I can also assure you that the two executives pictured on Page 10 agree with me, hence their decision to implement the WK-Body for the 2005 Jeep Grand Cherokee, a vehicle that truly has “*an excellent safety record.*”

To assert that a vehicle is “*in compliance,*” and enter that vehicle into the stream of commerce, when it is known that major revisions to vehicle configuration (e.g. SUV ride height), which were not anticipated or addressed by standards that are decades old, amounts to the crimes of gross criminal negligence and commercial fraud. The fact is, the United States Transportation Safety Act, as well as state-by-state commercial codes, require that when a unique FMEA is identified, it is the legal responsibility of the manufacturer to address it, prior to sale to the public.

Intermission : A Brief Summary of the Sections Above

1. The first time a jury was given the opportunity to review detailed facts about the 'Jeep fuel system crashworthiness defect' they assessed the offending/colliding driver with a fault of only 1%, while assessing that the FCA fault was 99%. The former has or will have a criminal record, the latter is free to enjoy, life, limb and luxury.
2. The victims of the 'Jeep fuel system crashworthiness defect' are two-fold: The primary victims are those horribly burned or horribly burned-to-death (and their families and friends). The secondary victim is the offending/colliding driver. Had these collisions involved an SUV other than the defective Jeeps, the legal outcome would have been restricted to bent fenders and traffic fines. It is the drama and horror (of removing burnt corpses from the Jeep) that motivates politically oriented public officials to prosecute criminal action against the 1% secondary victim, while turning a blind-eye to the 99% culprits.
3. Despite their PR and defense lawyer "*ultra-high energy, ultra-high speed crash*" rhetoric, FCA and NHTSA/DOT are both fully aware that in each case discussed above, and many others, all of the primary victims survived the initial crash with no or little injury; none of which were life threatening.
4. The FCA defense lawyer ruse that an unidentified draftsman in an internal group called "packaging" made the overall Jeep design architecture decisions, including the decision to locate its fuel tank in the rear-most position, is not a testimonial mistake or a misstatement: **it is perjury**. I can assure you that a FCA draftsman did not make the architecture decisions of the 1987 N-Body.
5. The safety management priority should be Failure Mode Effects Analysis (FMEA), not 'compliance with all government safety standards' or convolutions about 'NHTSA statistics.' What matters in the management of safety is that if a failure mode exists, and its provocation in the real world will have the effect of causing serious harm, then elimination of the failure mode is our duty.
6. Repeatedly when the layperson, such as the peers of a jury, learn that the auto industry has foreknowledge that a government safety standard fails to address a failure mode, that standard and related NHTSA statistics are rendered not merely irrelevant, but legally and morally vacuous.
7. Despite their PR and defense lawyer rhetoric, Chrysler *per se* did **NOT** "*move the Jeep fuel tank in 2005.*" Consistent with corporate and product management practices, overall design decisions for the WK-Body were made at the highest levels of executive management, in this instance executive management at Daimler-Chrysler.
8. FCA and NHTSA/DOT are fully aware that since introduction in 2005, in rear-end collisions to the WK-Body Jeep Grand Cherokee, there have been zero fire deaths and zero fire injuries . . . because there have been zero fires . . . a statistic that would have prevailed earlier had the N-Body base been implemented as the 1993 Jeep Grand Cherokee.
9. Despite PR and defense lawyer ranting about "*ultra-high energy, ultra-high speed crash,*" FCA and NHTSA/DOT are fully aware of the CAS testing wherein the primary competition to the Jeep SUV (Ford Explorer, with a mid-mounted fuel tank) sustained impacts of 70 and 75 miles per hour with no fuel leaks and no fire.
10. FCA and NHTSA/DOT are fully aware of the Baker memo of 1978, and the portent of that widely-distributed document, which details the criteria that future fuel system designs must include to improve crashworthiness; specifically warning of the dangers of rear mounted and unprotected fuel tanks.

Intermission : A Brief Summary of the Sections Above con't

11. FCA and NHTSA/DOT are fully aware that in the context of the Baker memo (and other criteria) that the undersigned, when acting as the Engineering Programs Manager for the Dodge Dakota, proposed that the engineering design of the 1993 Jeep Grand Cherokee be based on the N-Body. FCA and NHTSA/DOT are fully aware that the N-Body design had a mid-mounted fuel tank that has vastly superior crashworthiness versus the ZJ. The Chrysler executive decision to proceed with the ZJ prolonged the Jeep tradition of having a rear-mounted fuel tank; a location that is *"in the crush zone."*
12. What FCA, NHTSA/DOT and many plaintiffs may not have comprehended, is that if #11 had been endorsed, and the 1993 Jeep Grand Cherokee had utilized the N-Body engineering design, with its mid-mounted fuel tank, then all subsequent Jeep product variations, **such as the Jeep Liberty**, would have carried-forward this underlying mid-mount design. This is the exact Jeep design history that has occurred subsequent to the implementation of the 2005 WK-Body.
13. FCA, NHTSA/DOT and the Subject plaintiffs may not realize that if #11 had been endorsed, and the Jeep vehicles were revised to a mid-mounted fuel tank, similar to the N-Body, the Ford Explorer, or the 2005 WK-Body, then the 2003 Jeep Liberty that was driven by a 23-year-old expecting mother would have had a similar design . . . and she would have given birth to her son Braedin . . . **rather than she and Braedin being lowered into early graves in Michigan.**

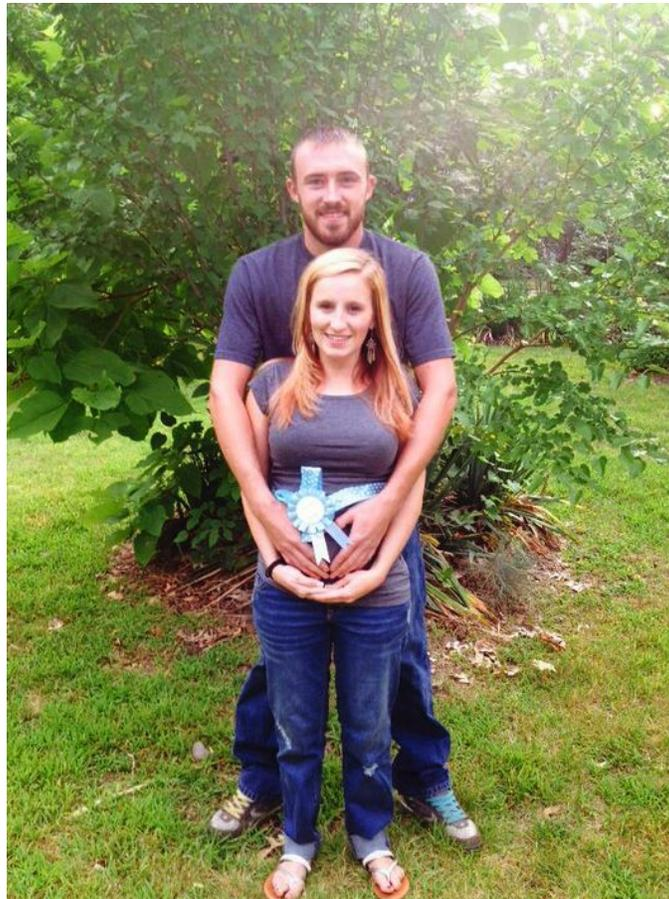

14. Items 1 thru 13 all occurred prior to November 11, 2014. Knowledge of, and documentation of Items 1 thru 13 were in the possession of both FCA and NHTSA/DOT prior to November 11, 2014. Despite these facts, **FCA and NHTSA/DOT acted and failed-to-act in a manner that led directly to Kayla and her son Braedin being sanctified by two closed-coffin funerals.** This reality is detailed next.

Criminal Conspiratorial Closure of NHTSA EA12-005: Jeep Fuel System Crashworthiness Defect

This section requires at least two contexts:

1. We live in a society that has capitulated to “public service” that is predicated-on and restricted by the vile notion contained in the adage:

“Too big to fail !”

Although beyond the scope of the Subject, this adage was spewed by the same private/public condominium that later orchestrated “bankruptcy” for General Motors and Chrysler. This so-called bankruptcy included billions-of-dollars for a “bailout.” So which is it?

But the more insidious motivation of the bankruptcy/bailout ruse was Section 362. The bankruptcy court obviated, in blatant violation of the Constitution, the rights of the estate of Susan Kline, and many others. The ‘Notice of Suggestion of Bankruptcy’ facsimiles have time-stamps of mere minutes after the bankruptcy order was signed in New York. These events were not coincidental; in itself, these too comprised criminal conspiracy. So, while the Kline estate was told to “*pound sand*,” it was simultaneously told to fund the bailout! ^Y

Relevant to the Subject, those individuals that orchestrated the closure of the NHTSA EA-12-005 did so in the context of “*Too big to fail!*” Their attitude (confirmed by the media, as well as the evidence in the Walden trial) is characterized by their deeds and words; that they can do whatever they want, whenever they want, and there is nothing American society or state Attorneys General will do about it.

2. Pasted below is a section from Page 12 of my August 20, 2014 letter. It was copied to Acting NHTSA Administrator David Friedman, and DOT Secretary Anthony Fox. It was received three months prior to the manslaughter of Ms. Kayla Lucille White and her unborn son Braedin:

Letters to NHTSA/CAS	Encapsulation	Skid Plate	Trailer Hitch
1 June 2010	0	7	0
9 February 2011	0	15	0
5 December 2011	1	2	0
27 August 2012	17	45	0
3 September 2012	0	1	0
24 September 2012	1	6	0
1 January 2013	1	3	0
12 February 2013	23	41	0

Former NHTSA Administrator David Strickland, former DOT Secretary Raymond LaHood, FCA Chairman Sergio Marchionne, acting NHTSA Administrator Freidman and DOT Secretary Fox have never functioned as an auto industry safety manager.

My table above depicts the frequency, in the four years of prior letters, that I advocated the notion that a “trailer hitch” is a crashworthiness device. I use quotation marks because, later, the conspirators had to publically admit that their “trailer hitch remedy” could not even tow!

This #2 includes the conspiratorial convolution that Strickland, LaHood and Marchionne agreed to, the not-so-subtle ploy that has come to be known as “***Anything but Sheridan.***”

That is, if I had reported, testified, or stated in my letters or to the media that red wine was my remedy for the EA12-005 defects, then FCA and their subordinates at NHTSA/DOT would have declared green cheese . . .

Conspiratorial Closure of NHTSA EA12-005 : The MOPAR “Trailer Hitch Remedy” Fraud

A secret meeting was held on June 9, 2013, in a Chicago conference room between the following:

Former Transportation Secretary Ray LaHood
Former NHTSA Administrator David Strickland
FCA Chairman Sergio Marchionne ^Z



The petitioner which had requested the investigation of the Jeep fuel system crashworthiness defect, Center for Auto Safety, Director Clarence Ditlow, was not informed of the meeting, nor was he invited.

To understand that their pronounced “trailer hitch remedy” is not merely incompetent, but criminal, a perspective steeped in technical, historical and legal details is required.

The technical and legal perspective briefly discussed next provides the basis for the demand that the fire-death of Ms. Kayla Lucille White be investigated by your office, not as a civil matter, but as a crime; the crime of manslaughter:

- A. On page 8 above, the Baker memo and how it was forwarded to NHTSA/DOT is discussed. Do you see the term “trailer hitch” anywhere in that 1978 document? ^{AA}
- B. In 1985 Chrysler Engineering, prior to the purchase of American Motors’ Jeep in 1987, published “FUEL SUPPLY SYSTEM DESIGN GUIDELINES.” It discusses at-length the designs implicit to fuel system crashworthiness. Do you see the term “trailer hitch” anywhere in that document? ^{BB}
- C. In my first interview with the media in support of the CAS petition, I discuss the fire-death of Mrs. Susan Kline. In the following October 2009 report, do you hear me, or anyone else, present the notion that a “trailer hitch” is Jeep fuel system crashworthiness remedy?

https://www.youtube.com/watch?v=TH_0izSyPk0

Instead, you will repeatedly hear the terms “skid plate” and “encapsulate.” ^{CC}

Conspiratorial Closure of NHTSA EA12-005 : The MOPAR "Trailer Hitch Remedy" MOPAR – con't

D. In my first letter supporting of the Petition, written on June 1, 2010, I copied Mr. Strickland. In addition to the Baker memo, I discuss "SAFETY RECALL A-10" of February 2002. Looking at Attachment 1 of my June 1, 2010 letter, note that Daimler-Chrysler declared that a "trailer hitch" was irrelevant to fixing a fuel tank crashworthiness issue! Note that not only does my cover letter emphasize the "skid plate" as a remedy, so does A-10! On the very first page the latter states:

"Those vehicles that have been repaired by having a skid plate installed do not require additional service"

In their A-10 letter to NHTSA of January 4, 2002, DaimlerChrysler stated:

"It was established that development and validation testing of the On-Board Refueling Vapor Recovery (ORVR) system had been conducted in a vehicle configuration containing a fuel tank skid plate."

Why? Because validation tests conducted with a trailer hitch COULD NOT AND DID NOT COMPLY.

Attached to the A-10 letter was a broadcast email to the Jeep dealership network:

As an interim repair, dealers may replace the fuel tank brush guard with a skid plate. Due to the limited availability of skid plate assemblies, DEALERS ARE REQUESTED TO ORDER SKID PLATE P/N 52100376AG TO REPAIR ONLY THOSE UNSOLD VEHICLES THAT HAVE A PROSPECTIVE RETAIL CUSTOMER. Additional skid plates will be available in the near future.

On that instructions page, DaimlerChrysler openly ignores the presence of the trailer hitch, since its presence is not, and never will be a crashworthiness defect remedy:

18. For vehicles equipped with a trailer hitch, loosen but do NOT remove, the two (2) rear-most trailer hitch bolts.
19. For vehicles equipped with a trailer hitch, use a pry bar (between brush guard and hitch) to flex the left upper leg of the brush guard inboard to allow it to pass below the trailer hitch.
20. For vehicles equipped with a trailer hitch, use a pry bar (between brush guard and hitch) to flex the right upper leg of the brush guard inboard to allow it to pass below

"SAFETY RECALL A-10" involves the WJ-Body version of the Jeep Grand Cherokee. This is the version that, while his mother and aunt looked-on in horror, burned 4-year-old Remington Walden to death. At no time during the trial of Walden did the defense lawyers propose that if the Walden Jeep had a "trailer hitch" then Remington would be alive.

Detailed next, dropping the WJ-Body by NHTSA/DOT from the "trailer hitch" recall was a blatant fraud, a criminal act that was not premised on safety. It has been alleged that one priority included accommodation to their future employment FCA or employers who work in the latter's behalf. ^{DD}

Conspiratorial Closure of NHTSA EA12-005 : The MOPAR “Trailer Hitch Remedy” MOPAR – con’t

E. The WJ-Body Jeep Grand Cherokee, that burned 4-year-old Remington Walden to death, was not included in the June 9, 2013 “deal” between LaHood, Strickland and Marchionne. The reason is two-fold.

- i. With accommodation prioritized in emails between them, it is not strident to presume that a NHTSA determination of “*not defective*” would accommodate the defense at the upcoming WJ-Body trial in Georgia. So does it surprise you to learn that an attempt was made by FCA lawyers to exclude the entire NHTSA/DOT investigation? ^{EE}

But, as if on-cue, a reimaging of that defense lawyer farce was attempted in the post-trial FCA press releases; the latter bold-facedly lied to the public ^{FF}

FCA US LLC Statement Regarding Walden v Chrysler Group Verdict:

April 2, 2015 , Auburn Hills, Mich. - FCA US is disappointed and will consider an appeal of this verdict. **It is unfortunate that under Georgia Law the jury was prevented from taking into account extensive data submitted to NHTSA during a three year investigation,** which included more than 20 years of rear impact accident data for tens of millions of vehicles. This and other information provided the basis for NHTSA’s determination that the 1999 Jeep Grand Cherokee did not pose an unreasonable risk to motor vehicle safety.

As FCA defense lawyers and PR staff are fully aware, it was FCA, not the plaintiff, that filed a motion to exclude all EA12-005 investigation evidence! The Court ruling states:

“Chrysler filed its motion in limine number 5 ‘to exclude evidence of or reference to a NHTSA investigation of Jeep vehicles.’ ”

Not only did Chicago include NHTSA/DOT’s pre-trial deletion of the Walden Jeep from the investigation, it also included agreeing to the fraud of “no defect” on that particular version. ^{GG}

- ii. WJ-Body deletion from EA12-005 was accommodated because of the esoteric difficulties of a “trailer hitch” recall on this version of the Grand Cherokee. The prior 1993 thru 1998 ZJ-Body version is simple; the installation is cheap, oriented below the rear fascia, and a simple bolt-on.

Not so on the 1999 thru 2004 WJ-Body, which is far more expensive, in terms of the replacement parts involved, and how much labor time/cost would be consumed in the FCA dealership service bay :



Conspiratorial Closure of NHTSA EA12-005 : The MOPAR “Trailer Hitch Remedy” MOPAR – con’t

F. As discussed in paragraph E, a major motivation of the NHTSA/DOT accommodation of FCA involved a joint pronouncement that the EA12-005 Jeeps were “*not defective.*” To proceed with this fraud, members of the NHTSA Office of Defects Investigation (ODI), the group that had already determined that a defect existed, were left ignorant of the secret emails, and were purposely excluded from the meeting between LaHood, Strickland and Marchionne.

But on June 3, 2013, a mere five business days prior to the secret meeting in Chicago, ODI sent FCA a private 13-page letter which states:

“As discussed more fully below, ODI believes that the MY 1993 – 2004 Grand Cherokee and the 2002 – 2007 Jeep Liberty contain defects related to motor vehicle safety.” ^{HH}

Note that ODI had NOT dropped the WJ-Body. On page 2 ODI specifically included the WJ-Body:

ODI’s analysis revealed that the MY 2002- 2007 Jeep Liberty and the MY 1993-2004 Grand Cherokee performed poorly when compared to all but one of the MY 1993-2007 peer vehicles, particularly in terms of fatalities, fires without fatalities, and fuel leaks in rear end impacts and crashes.

And nowhere did ODI propose a “trailer hitch” as crashworthiness device. Like the Petitioner (CAS), ODI was informed after-the-fact that LaHood, Strickland and Marchionne had unilaterally declared that, for the first time in automotive history, that a “trailer hitch” was safety device, and that the only version that would fix the failure modes of the Jeep fuel system crashworthiness defect was the MOPAR version!

Further, and with no explanation whatsoever to CAS, ODI or the public, both the 1993-2001 XJ-Body Jeep Cherokee and the 1999-2004 Jeep Grand Cherokee, which were originally part of EA12-005, were mysteriously dropped by LaHood, Strickland and Marchionne. Does it surprise you that both of these vehicles were/are the focus of litigation? But matters only get more corrupt . . . and more deadly.

- i. Four months before the manslaughter of Ms. Kayla White and her unborn son Braedin, and a full year after the conspiratorial closure of EA12-005, NHTSA Chief Counsel Mr. Kevin Vincent was compelled to send FCA the SPECIAL ORDER DIRECTED AT CHRYSLER GROUP LLC.
- ii. Dated July 2, 2014, this SPECIAL ORDER reveals that the LaHood, Strickland and Marchionne “trailer hitch” remedy was baseless. The Special Order, not openly shared with the public, states:

“In response to ODIs concerns, Chrysler provided drawings of the hitches and a limited set of test data. In ODIs view the test data provided by Chrysler was insufficient. However, when asked, Chrysler indicated that it would not conduct any testing or supply more data.”

The skimpy “test data” supplied to ODI was irrelevant, having nothing to do with crashworthiness. From a historical standpoint, how could it!? The trailer hitch had never been designed or used as a safety device. As indicated by Vincent, not only had FCA not done any testing of their “remedy,” they refused to do any! Not only hadn’t they done any testing with a MOPAR version, they hadn’t and STILL have not done any crash testing with ANY brand of hitch. Later, the tax payer wound up doing it through ODI . . .

But relevant to the double manslaughter of November 11, 2014 . . . the LaHood-Strickland-Marchionne MOPAR “deal” **was technically baseless, morally and ethically vacuous, and legally it was fraud.** ^{II}

Conspiratorial Closure of NHTSA EA12-005 : The MOPAR “Trailer Hitch Remedy” MOPAR – con’t

G. Aired on June 21, 2012, a full year before the secret Chicago meeting, my second media interview was filmed in Washington, DC, just up the street from Strickland’s and LaHood’s offices:

<http://www.wusa9.com/story/local/2012/06/21/3954461/>

In this interview, which aired a year before the “deal,” I referenced the crash tests I had witnessed and validated in behalf of the Petitioner:

“I’d like NHTSA to conduct their own crash tests.” JJ

Do you hear anyone in that report promote the notion that a “trailer hitch” is a Jeep crashworthiness remedy? At the bottom of that webpage, do you see a link to a “trailer hitch” supplier?

H. Two months after my second media interview, on August 3, 2012, I was deposed in the Jeep fire-death litigation of Susan Kline. How many times did the defense lawyer inquire about or propose the validity of a “trailer hitch” as a crashworthiness defect remedy? Never.

Alternatively, it was my expert opinion regarding “encapsulation” and “skid plate” that was examined extensively. My Kline deposition and Expert Report were forwarded to FCA and NHTSA/DOT. This led to “*Anything but Sheridan*” (See Page 15 above). Serreptiously, any NHTSA/DOT staff that accredits the plaintiff’s expert is barred from future FCA employment consideration. KK

I. In the years leading up to the mediated, sealed settlement of the Kline litigation, which included numerous depositions of FCA experts and corporate witnesses, how many times do you suppose they proposed a “trailer hitch” as a Jeep crashworthiness defect remedy? For emphasis, let us review the Kline case deposition of June 14, 2011 of an FCA corporate witness, the “*Father of the Jeep*” Francois Castaing:

“ Okay. I said earlier, I’m going to repeat one more time, that the Jeep ZJ fuel tank was protected by the body around it. It was not -- let me finish, let me finish -- it was not protected by the tow package! ”

This testimony was known to LaHood, Strickland and Marchionne two full years before their fraud. LL

J. A full year prior to his capitulation, Mr. Strickland received my letter of August 27, 2012 wherein I review and rebut the fraudulent response statements made by FCA (See Item G above). I made the following simple and relevant request of Strickland:

“Please request from Chrysler Group LLC all ‘high speed, high energy’ impact tests that support their public allegations that ‘a skid plate would have made no difference.’”

I made this request fully aware that no such FCA testing occurred, and therefore their media statements were characteristically fraudulent. Consistent with his anticipated employment, Strickland never replied, or formally made the request. With this as partial context, let us ask:

- i. How many of the horrible fire-injury or fire-deaths occurred in Jeeps equipped with a skid plate?
- ii. Alternatively, did any of the fire-injury or fire-deaths occur in Jeeps equipped with a “trailer hitch”? Of any brand?
- iii. **Central to the Conspiratorial Closure of NHTSA EA12-005, were NHTSA/DOT and FCA fully aware that the answer to Item ii above is a resounding ‘Yes!’ ?**

Conspiratorial Closure of NHTSA EA12-005 : The MOPAR “Trailer Hitch Remedy” Fraud – con’t

K. Page 3 above introduced you to Ana Pina`. Let us be reminded of her past, and her present:



As NHTSA/DOT and FCA are fully aware, the Pina' litigation is pending. She was riding on an Indiana highway in January 2012, almost two years prior to the Chicago “deal” when her XJ-Body Jeep Cherokee was hit from behind and exploded into a conflagration that she could not escape.

The XJ was mysteriously dropped from EA12-005 by LaHood, Strickland and Marchionne. Later under proverbial marching orders dictated by that conspiratorial closure, the XJ deletion was justified by ODI because the **“data for the Cherokee did not establish an unreasonable risk.”**



In accommodation to their “deal,” the datum that NHTSA’s ODI conveniently omitted was that Ana’s Jeep Cherokee was known by them to have been equipped with a trailer hitch.

Conspiratorial Closure of NHTSA EA12-005 : The MOPAR “Trailer Hitch Remedy” Fraud – con’t

- L. Buried as “Confidential” in the EA12-005 file, and therefore obscured from public scrutiny, is the horrific fire-death case of 4-year-old Cassidy Jarmon:



Obscuration of the Jarmon file was accommodated by NHTSA/DOT under the FCA ruse that it contained “*trade secret, proprietary and confidential information.*” That claim is not a misstatement or a legal mistake, **it is a bold-faced lie.** There is nothing in the entire litigation, let-alone what comprised the redacted file forwarded to EA12-005, that even remotely sustains the rubbish that full disclosure:

“ . . . could enable a competitor to determine the kinds of analysis that Chrysler performs in the design process, allowing them to benchmark and replicate Chrysler’s design procedures without incurring the substantial time and cost associated with independent development of such parameters and processes.”

What was crucial was the fact that upon her fire-death on February 12, 2006, the trailer hitch, that was mounted to the 1993 Jeep Grand Cherokee she was riding in, could not and did not function as a “remedy.” What was crucial was that the public remain ignorant of the original lawsuit verbiage ^{MM} :

- s. In failing to provide adequate warnings concerning the rear structural crash performance of the vehicle when fitted with a trailer two hitch;
- t. In failing to design the vehicle in such a manner that the rear structure was crashworthy when fitted with a trailer hitch;

Of what possible value could this type of information have to a competitor . . . **other than the latter’s ability to then “benchmark” how NOT to design an SUV fuel system?**

Conspiratorial Closure of NHTSA EA12-005 : The MOPAR “Trailer Hitch Remedy” MOPAR – con’t

M. Ms. Jenelle Embrey, her Dad and a young boy were eye and ear witnesses to two fire-deaths in a 1998 Jeep Grand Cherokee. Ms. Embrey’s Dad, Mr. Harry Hamilton who saved the boy from the Jeep conflagration, later received the Carnegie Medal for bravery.

The surviving boy Zachary watched as his mom Heather Santor and his friend Acoye` Breckenridge screamed in agony, and then became silent . . . the only sound remaining were gasps from other witnesses, the sounds of a burning Jeep, and the smells of burning human flesh. Zachary, Heather and Acoye all survived the crash on October 12, 2012, about nine months prior to the secret Chicago “deal.” ^{NN}

A few weeks after the LaHood-Strickland-Marchionne “trailer hitch” sham, Ms. Embrey requested a meeting with NHTSA Administrator Strickland. Throughout the meeting of July 1, 2013 the participants questioned the validity of the “remedy.” It was clear that Strickland could not answer his own rhetoric question:



Strickland never admitted the truth, that he and LaHood were fully aware that their capitulation to FCA was technically and empirically baseless. (I think he meant to exclaim, “. . . the unreasonable risk *to* safety.”)

Key people attended. Mr. Lynn Grisham, the attorney for Cassidy Jarmon, the 4-year-old girl who burned to death in a trailer hitch equipped Jeep Grand Cherokee. Ana Pina`, who burned horribly in a trailer hitch equipped Jeep Cherokee, and her attorney Ines Murphy. Ms. Angel DeFilippo, the attorney for Susan Kline, the death case that prompted the CAS petition. The petitioner, CAS Director Clarence Ditlow and former NHTSA Administrator Joan Claybrook attended. Unlike Chicago, ODI was invited and in attendance.

An excellent media report on the content of the July 1, 2013 meeting:

<https://www.youtube.com/watch?v=pL4yFeQBN-A>

A transcript of Strickland’s bureaucratic spectacle: <http://dangerousjeeps.com/transcript/>

The audio recording: <http://pvsherdan.com/NHTSA-Jeep-Victims-Meeting-Audio-1Jul2013.WMA>

A copy of Ms. Embrey’s charity-benefactor book, “Dangerous Jeeps and Me,” which discusses the horror of October 12, 2102 and the NHTSA meeting:

<http://www.amazon.com/Dangerous-Jeeps-Me-Black-Edition/dp/1508937583>

Conspiratorial Closure of NHTSA EA12-005 : The MOPAR “Trailer Hitch Remedy” MOPAR – con’t

N. Even “*the eighty-two million dollar man*” could not anticipate the following buffoonery. ○○

i. Prior to the \$150,000,000.00 jury verdict in Walden vs FCA, lawyers for the plaintiff inserted into their case scores of Other Similar Incidents, OSIs, of Jeep fire-injury and Jeep fire-death incidents. FCA defense lawyers filed their routine objections to ALL the OSIs.

ii. Astoundingly FCA objected to the Cassidy Jarmon fire-death OSI **on the specific basis that it had a trailer hitch!** FCA did not object that it was not the same version Jeep Grand Cherokee. The Jarmon Jeep was a ZJ. But the Walden Jeep was the WJ; the WJ that NHTSA/DOT had conveniently deleted from EA12-005 in accommodation to FCA. The Georgia court order states:

14. Jarmon

- a. vehicle: 1993 Jeep Grand Cherokee
- b. date of incident: February 12, 2006
- c. notice: notice shown on March 20, 2007 (Plaintiffs’ Ex. 507)
- d. notes: Chrysler argues that this OSI should be excluded because this Jeep had a trailer hitch, whereas the Jeep in which Remington Walden was riding did not. Plaintiffs respond that the presence of a trailer hitch is not determinative with regard to substantial similarity, particularly because Chrysler has contended that a trailer hitch is the ‘remedy’ for certain rear-tank Jeeps—and therefore cannot validly contend that trailer hitches were the cause of failure. If Chrysler elects to argue to the jury that this OSI should be disregarded because of the presence of a trailer hitch, Chrysler is free to do so.
- e. ruling: Chrysler’s objection to this evidence is:

In secret, NHTSA/DOT and FCA are “*Too big to fail !*” But if the forum is open court their primary defense routine is concealment, a tactic that infuriates even the most “conservative” juror. Noting page 18 above, contrary to their fraudulent post-verdict press release, it was FCA that moved to exclude EA-12-005. ^{PP}

If the Jarmon OSI is admitted, then the plaintiff examines all the validation crash tests of the “trailer hitch remedy” **that never happened!**

If the Jarmon OSI is admitted, then the Georgia jury hears that FCA and NHTSA/DOT knew, before their “deal,” that in accidents where victims survive a trailer hitch equipped Jeep, **the hitch made no difference or even contributed to the fuel tank breach and the fire-death!**

If they allow the Jarmon OSI, then the jury discovers that the trailer hitch was known be ineffective on a ZJ version of the Jeep, and therefore will inquire about the basis of the NHTSA/DOT/FCA claim of “remedy.”

If they allow the Jarmon OSI, then the jury will inquire about its absence on the WJ-Body version that burned Remington to death, and inquire why that version was conveniently deleted from the “investigation.”

The underlying motivation for the FCA exclusion of **any** trailer hitch OSI was their fear that the floodgates would open on the criminal fraud endemic to the entire conspiratorial closure of EA12-005.

Admittance of **any** trailer hitch OSI exposes, for example, that the FMEA that is not addressed by their “remedy,” is the precise failure mode that led to the double manslaughter of November 11, 2014.

Conspiratorial Closure of NHTSA EA12-005 : Cover-up by the “Honorable” DOT Inspector General

The website of the Attorney General for Michigan would presumably address the Department of Transportation Inspector General as “Honorable.” Let us review the validity of that presumption.

Two months prior to the double manslaughter of November 11, 2014, I wrote to DOT Inspector General Calvin L. Scovell, requesting his action on the following subject:

“Criminal Investigation of Fiat Chrysler Automobiles, and DOT-IG review of NHTSA EA12-005” QQ

The *“Too big to fail !”* response needs background . . . The CAS petition of October 2009 requested investigation of Jeep fuel system crashworthiness. It involved detailed safety data and concepts spanning decades, taking months to complete. The CAS follow-up has been voluminous. My assistance in support of that petition spans six years. However, Mr. Scovell made, what he called, an *“independent judgment”* regarding these complex matters in just a few days . . . pronouncing:

“We are unable to reply to further communications on this matter.” RR

Two months after my letter of September 11, 2014 to Scovell, the following live photograph was taken on Michigan’s Lodge Freeway, just east of the northbound Telegraph Road exit in Southfield, Michigan:



The presumed use of the salutation “Honorable” by the website of the Attorney General for Michigan in reference to the current Department of Transportation Inspector General is, at the very least, questionable.

Criminal Investigation of those Responsible for the Manslaughter of Ms. Kayla Lucille White

For proper perspective we should note that the last name, of the young expecting mother in the coffin pictured above, is **not** any of the following:

Castaing	Viergutz	Eaton
Lutz	DeGraw	Friedman
Foxx	Obama	Lynch
Scovell	Holder	Jefferies
LaHood	Strickland	Marchionne
Elkann	Rosekind	Schuette

Excluding (for the moment) the final name in that list, it is routine for many to routinely describe what happened on November 11, 2014 as:

“an unfortunate statistic.”

In the days that followed that date, as if on-cue, the public relations and defense lawyer rhetoric immediately commenced with fabrications associated with the following routine lie :

“Ultra High Energy – Ultra High Speed Crash”

And then, once again relying on the (literal) ignorance and naiveté of the taxpayer, FCA moved-on to the following NHTSA Strawman endorsement:

“All Jeep vehicles meet or exceed all applicable Federal Safety standards, and have an excellent real world safety record . . . Our priority continues to be on designing vehicles that perform safely for our customers and their families in everyday driving conditions.”

Again, it must be emphasized that, with the notable exception of the Walden vs FCA verdict of \$150,000,000.00 on April 2, 2015, summary Items 1 thru 13 above occurred before November 11, 2014. But none of those items or the content of the Walden trial evidence were shared with Ms. Kayla White.

In fact, the exact opposite was conveyed to her by both FCA, and the Jim Riehl's Friendly Chrysler Jeep dealership she had visited about the “trailer hitch recall.” Not only was she told that her 2003 Jeep Liberty was safe for her *“family in everyday driving conditions,”* Kayla was then told by the dealership that they did not have the (fraudulent) “trailer hitch remedy” parts anyway!



She should have been told NOT TO DRIVE THE JEEP UNTIL THE SAFETY DEFECT WAS TRULY FIXED. Despite acting responsibly, but in a state of naiveté, Kayla unknowingly placed her safety & well-being in the hands of criminals.

I am confident that if the expecting mother, pictured at left, who burned to death with her son on November 11, 2014, had any of the last names listed above, her information, her actions and her fate would have been otherwise.

Given the personalizing portent of your name being listed above, focusing on the vile “unfortunate statistic” routine, would such a conveyance to your daughter, of the type conveyed to Kayla, remain uninvestigated as a criminal matter?

Criminal Investigation of those Responsible for the Manslaughter of Ms. Kayla Lucille White - con't

A mere four months **prior** to their “trailer hitch deal,” **ALL THREE** pictured individuals received my letter of February 12, 2013:



I presented a **“Proposed EA12-005 Recall Remedy.”** Page 5 of that section had the following table:

Proposed EA-012 Recall Remedy – General Historical Incremental Piece Cost and Financial Summary

Based on the 4 February 1994 PPC approval data for the XJ-Body, the following financial data can be derived:

<i>Tracked Vehicle Financial Category</i>	4 Feb 1994 PPC Data	Factory or Dealership Incremental Cost: Fuel Tank Encapsulation	Incremental Cost of Fuel Tank Encapsulation as Percent of Category
Corporate Variable Cost	\$ 9737	\$50	0.5 %
Corporate Variable Margin	7644	\$50	0.6 %
Wholesale Delivered Price (WSD)	\$ 17381	\$50	0.3 %
Dealership Margin (approx.)	5000	\$100	2.0 %
Destination/Shipping Charge	465	n/a	n/a
Monroney Label MSRP (typical)	\$ 22846	\$100	0.4 %
<i>Long-Term Customer Financial Effects Analysis</i>			
Monthly Payment Assuming that Encapsulation Cost Absorbed by Chrysler	\$515.84	Assumes full financing of MSRP at 4.0% for 48 Months	
Monthly Payment Assuming Pass-through of Encapsulation Cost (“cost recovery”)	\$516.97	Assumes MSRP increased by \$50 Incremental Fuel Tank Encapsulation Cost to \$22896.	
Increment to Monthly Payment	\$1.13	n/a	0.2 %

Do you see “trailer hitch” anywhere? Do you note the phrase “Fuel Tank Encapsulation”?

The XJ-Body is similar to the KJ-Body Jeep Liberty in cost/pricing. The latter in my professional opinion is far more vulnerable to rear impact fuel tank breach and resulting fires. Even if you believe the farce that a “trailer hitch” would have saved Kayla and Braedin, that is NOT what she was told by FCA and the Jeep dealership. Kayla was told that 1) she was driving a vehicle that was safe “*in everyday driving conditions,*” and that they (the dealership) did not have the part anyway. Kayla *did* her public duty.

Given the personalizing portent of your name being listed above, focusing on the vile “*unfortunate statistic*” routine, would such a conveyance to your daughter, of the same type conveyed to Kayla, remain uninvestigated as a criminal matter? As a matter of your duty as the Attorney General for the State of Michigan?

Criminal Investigation of the Manslaughter of Ms. Kayla Lucille White - CONCLUSION

In my third media interview of July 2014 interview with WNDU-16 NBC News in Indiana. I stated concerns regarding the fraudulent recall and made a chilling prediction:

“No matter how small the probably of the fire death event is, Chrysler and NHTSA are deciding that the roll of dice is what constitutes safety, not the competent and urgent retrofitting of a competent remedy. So, the bottom line is, more deaths and more injuries are going to occur.” ^{SS}

I will not now disclose my detailed knowledge and opinions about the accident in Southfield, Michigan, which occurred a mere four months after my prediction. I will share what the Oakland County Medical Examiner Coroner’s Report states as the definitive cause of Kayla and Braedin’s death:

DATE PRONOUNCED: November 11, 2014 **TIME:** 5:10 p.m.

PLACE PRONOUNCED: Southfield

DATE OF AUTOPSY: November 12, 2014 **TIME:** 8:50 a.m.

CAUSE OF DEATH: THERMAL INJURY and SMOKE INHALATION

I can assure you that the phrase *“Ultra High Energy – Ultra High Speed Crash”* will not be found in the coroner’s report or the accident report. Regarding the latter, consistent with the primary victim scenarios discussed above, the secondary victim of November 11, 2014 has been criminally indicted for his role in the accident: Further:

- a. I am confident that the driver of the vehicle that collided with Kayla’s Jeep Liberty will admit guilt and take responsibility for the accident.
- b. I am confident that when a jury hears of Items 1 thru 13 above, and the additional facts surrounding November 11, 2014, that they will assess a guilt level for the driver of not more than 1%.
- c. I am confident that FCA will not admit any guilt for the fire and will not take any responsibility for the manslaughter of Kayla and her unborn son Braedin.
- d. I am confident that when a jury hears of Items 1 thru 13 above, and the additional facts surrounding November 11, 2014, that they will assess a guilt level for FCA of at least 99%.

My letter of February 12, 2015 to CAS makes the following dedication on page 1:

“Therefore, Subject 1 is now dedicated to the life that was taken from Ms. Kayla Lucille White, and the ongoing agony that is being endured by her family, fiancé and friends.”

Subject 1 is *“Criminal Investigation of DOT, NHTSA and FCA (Re: Closure of EA12-005).”* In that letter, and my previous letter of August 20, 2014, I list the definition of ‘Gross Criminal Negligence’:

“Gross negligence is culpable or criminal when accompanied by acts of commission or omission of a wanton or wilful nature, showing a reckless or indifferent disregard of the rights of others, under circumstances reasonably calculated to produce injury, or which make it not improbable that injury will be occasioned, and the offender knows, or is charged with the knowledge of, the probable result of his acts.” ^{TT}

Criminal Investigation of the Manslaughter of Ms. Kayla Lucille White - CONCLUSION - con't

I am confident that when a grand jury is convened for the purposes of a criminal investigation of the deaths of Kayla and Braedin, the members will assess that FCA and NHTSA/DOT acted in a manner that made it

“ . . . not improbable that injury will be occasioned, and the offender knows, or is charged with the knowledge of, the probable result of his acts.”

The members would recognize that Kayla made an informed decision to continue driving her Jeep Liberty; but that is was based on information she received from FCA, NHTSA, DOT and Jim Riehl's Friendly Chrysler Jeep dealership and that, unknown to her, that information amounted to commercial and criminal fraud, which led to the manslaughter of her and Braedin.

I am confident that members, noting that (civil) juries have assessed the minimum FCA guilt level at 99%, would decide that criminal indictments should be issued for at least the following individuals:

Francois Castaing	Sergio Marchionne	John Elkann
Raymond LaHood	David Strickland	Owen Viergutz
Anthony Foxx	David Friedman	Jim Riehl

It must be emphasized that we are dealing with organizations that are jointly guilty of decades of criminal activity. Indeed, the only hard copy attachments to this letter involve a two-page document that was authenticated by the highest levels of Chrysler Corporation. The effects of this closed-door conspiracy regarding NHTSA EA94-004 were exactly the same as NHTSA EA12-005 : Innocent, trusting individuals were both primary and secondary victims of manslaughter. Ironically, it was the Butler-Wooten firm, the firm that adjudicated the Walden verdict of \$150,000,000.00, that relied on my testimony in the death case of Flax vs Chrysler (See box, last paragraph, page 12 above). In that 2004 litigation the jury rendered a verdict of \$105,000,000.00 after hearing the following testimony, as published at Law.com ^{UU}

Sheridan said the committee also reviewed other safety complaints against minivans, which prompted an agreement involving Chrysler, the National Highway Traffic Safety Administration and the Justice Department. As part of that deal, Sheridan testified, NHTSA agreed that it would reject requests for information about minivan safety defects made under the federal Freedom of Information Act and Justice Department attorneys would defend NHTSA's refusal to release the requested material.

NHTSA's current general counsel, Jacqueline Glassman, formerly worked in the general counsel's office at Chrysler, Sheridan testified. According to Butler, NHTSA's former rulemaking chief, Barry Felrice, is now working at DaimlerChrysler.

Referencing the 'Public Integrity' tab of the Michigan Attorney General website, for decades the 99% officials from FCA, NHTSA, DOT, and DOJ have blatantly failed "*the public's trust.*" Please assume this letter offers your office the opportunity to assert the reverse in behalf Michigan citizens such as the 1% guilty (Clarence Quentin Heath) and the 0% guilty (Kayla and Braedin). ^{VV}

Please do not hesitate to contact me at any time. ^{WW}

Respectfully,

Paul V. Sheridan

Criminal Investigation of the Manslaughter of Ms. Kayla Lucille White

Endnotes

^A The 'Public Integrity' tab of the Michigan Attorney General website:

<http://www.michigan.gov/ag/0,4534,7-164-58056---,00.html>

^B The Biography tab of the Michigan Attorney General website

<http://www.michigan.gov/ag/0,4534,7-164-19441-248720--,00.html>

^C http://pvsheridan.com/Walden_Jury-Verdict-Form.pdf

^D http://pvsheridan.com/Remis_Burning_to_death_in_Jeep.pdf

^E <https://www.youtube.com/watch?v=97oqswkI14k>

^F https://www.youtube.com/watch?v=hzve_cmBj8Q

^G <http://pvsheridan.com/JeepGrandCherokeeDefectPetition.pdf>

^H <http://pvsheridan.com/Kline-ExplodingJeepWitness.pdf>

^I <http://pvsheridan.com/BantaDep-7Sep2012.pdf> page 132

http://pvsheridan.com/Dep_Banta-7Sep2012-Arrows.pdf

^J <http://pvsheridan.com/Castaing-Father-of-Jeeps.pdf>

^K http://pvsheridan.com/FJC-ORG-Chart_EX_001.pdf

^L http://pvsheridan.com/Sheridan_Sells_Cummins2Garlitz.pdf

^M http://pvsheridan.com/Castaing_Org_Chart_H.pdf

^N <http://pvsheridan.com/CastaingTenagliaDep-Jeep-Partial.pdf>

^O http://pvsheridan.com/PressRelease-150_million_dollar_verdict_against_Chrysler.pdf

^P <http://pvsheridan.com/Castaing-14Jun11-Complete----.pdf>

^Q http://pvsheridan.com/Viergutz-Kline-EX_002.pdf

^R http://pvsheridan.com/PressRelease_of_PaulVSheridan.pdf

^S http://pvsheridan.com/Baker-Sinclair_FuelMemo1978.pdf

^T <http://pvsheridan.com/Cage-WJ-Body.pdf>

U http://pvsheridan.com/Chrysler_Destruction_Rear-Impact-Tech-Club_WK-Body_database.pdf

V http://pvsheridan.com/Dep_Phillip_Cousino_Walden_v_Chrysler.pdf

W <http://www.autosafety.org/jeep-grand-cherokee-crash-tests>

https://www.youtube.com/watch?v=rZh-Y_W5KS4 (Ford Explorer 70mph crash test with zero fuel leak)

<https://www.youtube.com/watch?v=l03eGY8MvZI> (Ford Explorer 70mph crash test with zero fuel leak)

http://pvsheridan.com/ZJ_RearImpacTest_FinalReport.pdf

X <https://www.youtube.com/watch?v=gQp6MG7w--s>

<https://www.youtube.com/watch?v=83lnbTVVGjk>

Y <http://pvsheridan.com/NOTICE-OF-SUGGESTION-OF-BANKRUPTCY.pdf>

<http://pvsheridan.com/Obama-Banruptcy-Victims-1-June2009.pdf>

Z http://www.denverpost.com/auto/news/ci_23508934?source=rss (Secret meeting of NHTSA/DOT/FCA)

AA http://pvsheridan.com/Baker-Sinclair_FuelMemo1978.pdf

BB http://pvsheridan.com/Chrysler_Fuel_Supply_Systems_Design_Guidelines.pdf

CC https://www.youtube.com/watch?v=TH_0izSyPk0 (First Sheridan media interview, September 2010)

DD <http://www.autosafety.org/automakers-stay-cozy-us-capital> :

“One was NHTSA's announcement that it was closing its contentious investigation of fuel tank fires in Chrysler Corp. SUVs, including its Jeep Grand Cherokees. The agency accepted the automaker's remedy of installing trailer hitches in more than 1.5 million vehicles to protect the tanks from rupture in rear-end collisions. **That's a solution that some safety advocates think may make the cars even more dangerous.** The other milestone was that it was the last day at work for David Strickland, the NHTSA administrator who had overseen the investigation and was leaving for a new job with Venable, a Washington law firm that lobbies for Chrysler.”

<https://www.venable.com/david-l-strickland/>

EE http://pvsheridan.com/Strickland_Emails_Marchionne_Meeting.pdf

FF

<http://www.media.chrysler.com/newsrelease.do;jsessionid=811F69226E35ABE82EFE866E347B8EDF?&id=16464&mid=>

GG http://pvsheridan.com/Walden_Order-on-NHTSA.pdf (exclude NHTSA)

HH <http://pvsheridan.com/ODI2FCA-3June2013.pdf>

II <http://www.wndu.com/home/headlines/Jeep-Recall-Recall-under-fire----Part-3-268361522.html>

JJ <http://www.wusa9.com/story/local/2012/06/21/3954461/> (Second Sheridan media interview, June 2012)

KK <http://pvsheridan.com/SheridanDep-KLINE-3Aug2012.pdf>

<http://pvsheridan.com/KlineReport-Revision-2Jan2012-Links.pdf> (huge file)

LL <http://pvsheridan.com/TowNoProtect-Castaing-14June2011.pdf>

<https://www.youtube.com/watch?v=BQt3LbwcLL8>

The FCA/NHTSA/DOT Jeep Recall - The Castaing Trailer Hitch Non-Protect Testimony

MM <http://pvsheridan.com/JarmonComplaint.pdf>

<http://pvsheridan.com/JarmonReport-2-NHTSA.pdf>

NN <http://www.wusa9.com/news/article/244865/37/Witness-Talks-About-Fiery-1998-Jeep-Grand-Cherokee-Crash>

OO http://pvsheridan.com/82_million.pdf

<http://pvsheridan.com/Sparhawk-Mohr-Testimony-Portion.doc>

PP http://pvsheridan.com/Walden_Order-on-OSIs.pdf

QQ <http://pvsheridan.com/Sheridan2Scovell-1-11Sep2014.pdf>

RR <http://pvsheridan.com/Scovell2Sheridan-1-26Sep2014.pdf>

SS <http://www.wndu.com/home/headlines/Jeep-Recall-Recall-under-fire----Part-3-268361522.html>

<https://www.youtube.com/watch?v=Mw07BU3g4ZY>

TT http://pvsheridan.com/Dep_of_Marchionne_01-09-2015.pdf

UU <http://pvsheridan.com/DOJ-NHTSA-ChryslerConspiracy-1.pdf>

VV <https://www.youtube.com/watch?v=aL8KrWfJtZI>

<http://www.cbsnews.com/videos/chrysler-ordered-to-pay-150-million-for-boys-death/>

WW <http://pvsheridan.com/Sheridan-SafetyLeadershipAward.pdf>

<http://pvsheridan.com/Sheridan-PerfApprls.pdf>

<http://pvsheridan.com/SLT-FormationLtr.pdf>

<http://pvsheridan.com/Tyrrell-Email-Watts.pdf>

Paul V. Sheridan letters, Jeep fuel tank crashworthiness defect investigation:

<http://pvsheridan.com/Sheridan2Ditlow-1-1June2010.pdf>

<http://pvsheridan.com/Sheridan2Strickland-1-9Feb2011.pdf>

<http://pvsheridan.com/Sheridan2Strickland-2-27Sep2011.pdf>

<http://pvsheridan.com/Sheridan2Strickland-3-5Dec2011.pdf>

<http://pvsheridan.com/Sheridan2Strickland-4-15Jun2012.pdf>

<http://pvsheridan.com/Sheridan2Strickland-5-27Jul2012.pdf>

<http://pvsheridan.com/Sheridan2Strickland-6-27Aug2012.pdf>

<http://pvsheridan.com/Sheridan2Strickland-7-3Sep2012.pdf> (Review of CAS Karco test of 16 May 2011)

<http://pvsheridan.com/Sheridan2Strickland-8-24Sep2012.pdf>

<http://pvsheridan.com/Sheridan2Strickland-9-1Jan2013.pdf>

<http://pvsheridan.com/Sheridan2Strickland-10-30Jan2013.pdf>

<http://pvsheridan.com/Sheridan2Strickland-11-12Feb2013.pdf>

<http://pvsheridan.com/Sheridan2Elkann-1-15Mar2013.pdf> (FedEx delivered in ITALY)

<http://pvsheridan.com/Sheridan2Strickland-12-18Mar2013.pdf>

<http://pvsheridan.com/Sheridan2Foxx-1-3May2013.pdf> (Prior to Foxx assumption of DOT)

<http://pvsheridan.com/Sheridan2Strickland-13-12June2013.pdf>

<http://pvsheridan.com/Sheridan2Ditlow-2-31May2014.pdf>

<http://pvsheridan.com/Sheridan2Ditlow-3-20Aug2014.pdf> (Discussion of ongoing/Chicago fraud)

<http://pvsheridan.com/Sheridan2Scovell-1-11Sep2014.pdf>

<http://pvsheridan.com/Scovell2Sheridan-1-26Sep2014.pdf> (Response from DOT IG)

<http://pvsheridan.com/Sheridan2Ditlow-4-12Feb2015.pdf>

<http://pvsheridan.com/Sheridan2Kelleher-1-11Apr2012.pdf> (Letter to NADA)

ATTACHMENT 1

Attorney General Bill Schuette
G. Mennen Williams Building
7th Floor
525 W. Ottawa Street
Lansing, MI 48909
517- 373-1110

23 April 2015

Subject: Criminal Investigation of those Responsible for the Manslaughter of Ms. Kayla White

Reference: Conspiratorial Closure of NHTSA EA12-005: Jeep Fuel System Crashworthiness Defect

Five Pages

It must be emphasized that we are dealing with organizations that are jointly guilty of decades of criminal activity. Indeed, the only hard copy attachments to this letter involve a two-page document that was authenticated by the two highest levels of Chrysler Corporation:

1. Two page internal Chrysler Corporation document detailing NHTSA, DOJ and Chrysler conspiracy to block Freedom of Information Act (FOIA) requests to release taxpayer funded crash test videos and documents of what was referred to, at the time, as:

“The deadliest defect involving children in auto safety history.”

Mr. Clarence Ditlow, Director, Center for Auto Safety, July 1995

2. Three page report at Law.com presenting the testimony of Safety Expert Paul V. Sheridan that led to the \$105,000,000.00 jury verdict in the death case of an infant in Flax vs Chrysler.

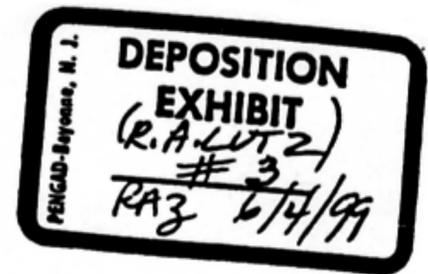

MINIVAN LATCH ISSUE

Proposed Agreement with NHTSA

1. Crash Test Video and the Public Record:

- NHTSA has agreed that they will deny all FOIA requests to place their investigative files, including the crash test video, on the public record and that the Department of Justice will defend any lawsuits seeking to compel production under FOIA.

We would agree with NHTSA that their engineering analysis will remain open while we conduct the service campaign to provide them additional bases to argue that release of the materials would interfere with their investigation.

- The Department of Justice says there is less than a 50/50 chance of keeping the video off the record for the full duration of the investigation, i.e. the campaign, if there is a court ruling. Given the possibility that a lawsuit could be filed at any time, they anticipate that the legal process would take at least four months, regardless of the outcome.

2. Service Action Only - No Recall: NHTSA has agreed that a Chrysler service campaign would fully satisfy all of their concerns and they would give full public support to such an effort. The critical elements that differentiate the service campaign from a recall (mostly reflected in the two attached letters) are as follows:

- no admission of defect or safety problem;
- stated purpose of the campaign - to ensure peace of mind in light of media coverage;
- campaign does not count as a NHTSA action - not included in NHTSA recall numbers, no Part 573 or Part 577 letters;
- statements to owners, the public and NHTSA assert that no defect has been found; and
- NHTSA acknowledges that replacement latch is not a 100% solution.

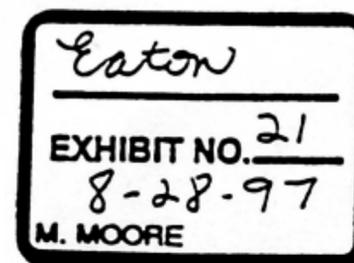

3. **Chrysler Announcement:** Chrysler controls publication of its action with the following provisions:

- Chrysler goes first with its own statement and reads approved NHTSA statement supporting Chrysler's action;
- Chrysler characterizes campaign as done solely to ensure the peace of mind of its owners, i.e. "your concern is our concern";
- Letter from Martinez to Chrysler and NHTSA press statement praise Chrysler action as fully satisfying all of NHTSA's concerns and state that Chrysler is a safety leader;
- NHTSA officials acknowledge publicly that there has been no finding of defect and that there will be none; and
- NHTSA officials acknowledge that owners should not be concerned over the delayed implementation of the action and that they can best protect themselves by keeping seat belts buckled at all times.

4. **Additional Provisions:** The following points have been requested by NHTSA and appear to be reasonable:

- The letter to owners makes reference to the NHTSA hot line phone number;
- Latch replacement will be offered as part of any routine minivan servicing (once replacement latches are available);
- Chrysler will submit six quarterly reports on the progress of the campaign (helps to support defense of FOIA requests); and
- NHTSA can make reference to the service campaign in response to owner inquiries.

LEGALTECH
ON DEMAND

Missed a session? Watch it here!

LAW.COM

Select '**Print**' in your browser menu to print this document.

Copyright 2009. Incisive Media US Properties, LLC. All rights reserved.

Page printed from: <http://www.law.com>

[Back to Article](#)

Tenn. Jury Returns \$105M Verdict Against DaimlerChrysler Over Minivan Seats

R. Robin McDonald
12-01-2004

A Tennessee jury has socked DaimlerChrysler Corp. for \$105.5 million after finding that a baby's 2001 death was caused by a faulty minivan seat.

The Nov. 23 verdict in the Tennessee case, *Flax v. DaimlerChrysler*, No. 02C1288, (Tenn. 1st Cir., Nov. 23, 2004), is one of four product liability cases that Columbus, Ga., attorney James E. Butler Jr. has brought against DaimlerChrysler targeting minivan seat backs that collapsed during collisions, injuring or killing passengers.

Butler said DaimlerChrysler previously settled two of those cases confidentially with his clients. Another one is awaiting trial in Orlando, Fla.

The three-week trial in Nashville, Tenn., featured the testimony of a former DaimlerChrysler manager, who testified that the automaker knew the seats in its minivans were unsafe and colluded with a federal regulatory agency to cover up the information, according to Butler and co-counsel George W. Fryhofer III, both partners at Butler, Wooten, Fryhofer, Daughtery & Crawford in Columbus and Atlanta.

Last week's verdict is one of at least a half-dozen big jury verdicts that Butler and his firm have secured in the past decade, many of them in vehicle product-liability cases. In two actions against General Motors Corp., Butler's firm won \$150 million in a 1996 SUV rollover case, and \$105 million in a 1993 case where a pickup's side fuel tanks caused it to burst into flame after a collision.

In 1998, the firm won a \$454 million verdict against Time Warner -- the largest civil verdict affirmed by the state appellate courts in Georgia's history -- on behalf of investors in Six Flags Over Georgia. In the suit, Six Flags investors accused Time Warner of skimping on capital investments, thereby lowering the park's market value and total worth.

2009 CORPORATE counsel Tech Survey Webinar **FREE**

WATCH NOW! Pre-Recorded Tech Survey Webinar

This year, we asked leaders of in-house legal departments how they use the technology they've got. [Click to read more.](#)

Hosted by: **Anthony Paonita**
Editor-In-Chief, Corporate Counsel

Sponsored by: **discovery**
by discovery inc.

REGISTER NOW

The 2008 Florida Billing Survey

DaimlerChrysler has vowed to appeal the Tennessee verdict, which includes \$98 million in punitive damages, claiming that the crash that led to 8-month-old Joshua Flax's death was caused by a reckless driver, not a flaw in the design of the automaker's Dodge Grand Caravan. In a news release distributed in response to calls for comment about the case, DaimlerChrysler labeled the verdict "grossly excessive, unconstitutional, and a miscarriage of justice."

Cleveland, Ohio, attorney Lawrence A. Sutter of Sutter, O'Connell, Mannion & Farchione defended DaimlerChrysler. Sutter's office referred questions about the verdict to DaimlerChrysler's American headquarters in Auburn Hills, Mich.

CHRYSLER: DRIVER ALSO RESPONSIBLE

DaimlerChrysler spokesman Michael Aberlich said that during the compensatory damages portion of the trial, jurors found that the speeding driver of the car that rear-ended the minivan, Louis A. Stockell Jr., shared equal responsibility for the baby's death. "But when it came to punitives, the company bore the brunt of it," Aberlich said.

The Tennessee case went to trial because the baby's parents, Jeremy Flax and Rachel Sparkman, "were people of very strong convictions," explained Fryhofer.

"Even though they had an opportunity to settle the case, they wanted to get the word out about this defect and realized the only way to do that was through a jury verdict," Fryhofer said. "They wanted to be sure no more parents had to watch their own kids killed or brain-damaged by these defects." Fryhofer said he could not disclose the settlement offers Daimler-Chrysler made.

At the end of the trial's first phase, the jury awarded \$5 million in compensatory damages for the baby's wrongful death and \$2.5 million to the child's mother for negligent infliction of emotion distress caused by witnessing the infant's fatal injury and death.

During the punitive damages portion of the trial, the jury deliberated just two hours before awarding \$98 million to the infant's parents. Butler said he had asked for \$100 million in punitives.

CARMAKER ACCUSED OF COVER-UP

Throughout the trial, the plaintiffs' attorneys accused DaimlerChrysler of a cover-up of "hundreds of other similar incidents" of seat back collapses resulting in passenger injury or death while it continued to market its Chrysler Town and Country minivan, Plymouth Voyager, and Dodge Caravan as safe, family friendly vehicles. The automaker has sold more than seven million minivans.

The backward collapse of front seat backs in the minivans during rear-end collisions would propel the drivers and front-seat passengers backward in a rear-end collision, often causing their heads to collide with children riding in the middle seats, Butler said. That is what happened to 8-month-old Joshua Flax when a driver slammed into the back of the baby's grandparents' minivan at 70 mph in 2001 in Nashville, he said.

Five other passengers walked away from the accident with only minor injuries. But the front-seat passenger's seat back collapsed, throwing a family friend backward. He was not injured, but his head collided with the baby's skull, fracturing it, said Fryhofer. Joshua Flax died the following day. The baby was injured "only because the seat back collapsed on him," Fryhofer said. "This has been a defect that has been brain-damaging and killing children in the family minivans for years."

"The horrible thing about these cases," said Butler, "is that in almost every case, it's a parent whose head kills or maims his or her own child."

RECORDS SEALED

Testimony during the Tennessee trial revealed that the automaker has sealed court records of an undisclosed number of suits involving failed minivan seat backs. A former Chrysler employee who testified at trial said he is aware of eight other cases, in addition to Butler's, that DaimlerChrysler has settled confidentially.

Butler said the automaker was compelled in the *Flax* case to inform Tennessee Circuit Judge Hamilton Gaden of the total number of seat back failure cases the company has settled and the sums paid to plaintiffs in each case. But Fryhofer said, over his and Butler's objections, the judge allowed DaimlerChrysler to file that information under seal. The attorneys also said they were barred by the court from informing the jury or releasing that information to the public.

"I guess they don't want the public to know," Butler said.

But Chrysler spokesman Aberlich argued that the manner in which the Flax baby's skull was fractured was "a freak occurrence."

"This was a high-speed accident," he said. "Many things can happen in a high-speed accident. My understanding is that five people walked away. The irony, the real sad irony, is that one did not."

Butler argued during the trial that DaimlerChrysler "has known for over 20 years" that its minivan seats were "deadly dangerous" because of their tendency to collapse backward during a collision.

Testimony from experts at the trial, among them former Chrysler manager Paul V. Sheridan, showed that minivan seats collapsed in every rear impact test the automaker conducted.

"Notwithstanding the knowledge that the seat was collapsing in all of its internal rear crash tests, Chrysler was encouraging parents to put children behind the seats they knew would collapse," Fryhofer said.

In 1992, Sheridan was appointed to chair Chrysler's "Minivan Safety Leadership Team" to investigate minivan safety concerns. The leadership team concluded that the collapsing seatbacks needed to be redesigned, but Chrysler disbanded the team and destroyed the minutes of its meetings, according to Sheridan's testimony.

MANAGER LATER FIRED

Sheridan said he was fired a month later. By then, he said, he had informed his superiors that he intended to go to federal regulators with his safety concerns. Sheridan said Chrysler then sued him to prevent him from speaking about the company. Chrysler later withdrew the suit.

Sheridan said the committee also reviewed other safety complaints against minivans, which prompted an agreement involving Chrysler, the National Highway Traffic Safety Administration and the Justice Department. As part of that deal, Sheridan testified, NHTSA agreed that it would reject requests for information about minivan safety defects made under the federal Freedom of Information Act and Justice Department attorneys would defend NHTSA's refusal to release the requested material.

NHTSA's current general counsel, Jacqueline Glassman, formerly worked in the general counsel's office at Chrysler, Sheridan testified. According to Butler, NHTSA's former rulemaking chief, Barry Felrice, is now working at DaimlerChrysler.

Company spokesman Aberlich said he could not verify information about the employment of Glassman or Felrice.

But the Chrysler spokesman argued that the company's minivan seat standards "far exceed" NHTSA standards. The seats, he said, are designed to absorb the impact of a crash. In minivan seats, the impact of a crash is reduced by the seat back collapse, he argued. While the plaintiffs' lawyers argued that a stronger seat was safer, Aberlich continued, "There is not a universal agreement as to which is better" among auto industry engineers."

END OF DOCUMENT

Attorney General Bill Schuette
G. Mennen Williams Building
7th Floor
525 W. Ottawa Street
Lansing, MI 48909
517- 373-1110

23 April 2015

Subject: Criminal Investigation of those Responsible for the Manslaughter of Ms. Kayla White

Reference: Conspiratorial Closure of NHTSA EA12-005: Jeep Fuel System Crashworthiness Defect

END OF DOCUMENT

29 April 2015

Attorney General Kamala D. Harris
Office of the Attorney General
1300 "I" Street
Sacramento, CA 95814-2919
916-445-9555

Subject: Criminal Investigation of those Responsible for Severe Injury to the Sanchez Brothers
Ref: Conspiratorial Closure of NHTSA EA12-005: Jeep Fuel System Crashworthiness Defect