



January 4, 2013

Dear Customer:

The following is the proof-of-delivery for tracking number **800793415951**.

Delivery Information:

Status:	Delivered	Delivered to:	Receptionist/Front Desk
Signed for by:	Y.CLARKE	Delivery location:	1200 NEW JERSEY AVE W43 20590
Service type:	FedEx 2Day	Delivery date:	Jan 4, 2013 11:53
Special Handling	Deliver Weekday Residential Delivery		



Shipping Information:

Tracking number:	800793415951	Ship date:	Jan 2, 2013
		Weight:	1.0 lbs/0.5 kg

Recipient:
DAVID STRICKLAND
NHTSA HDGTRS
1200 NEW JERSEY SE
WASHINGTON, DC 20590 US

Shipper:
PAUL V. SHERIDAN
SHERIDAN, PAUL V
22357 COLUMBIA ST
481243431 US

Reference EA12-005

Thank you for choosing FedEx.

To: Mr. David L. Strickland *
NHTSA Headquarters
West Building
1200 New Jersey Avenue, SE
Washington, DC 20590
202-366-4000

Date: 1 January 2013 VIA FEDEX AIRBILL 8007-9341-5951

From: Mr. Paul V. Sheridan
DDM Consultants
22357 Columbia Street
Dearborn, MI 48124-3431
313-277-5095 / pvs6@Cornell.edu

Subject: Chrysler Group, LLC Failure-to-Warn/Comply under 49 CFR § 573.6, et al.

Reference 1: Toyota Motor Corporation/NHTSA Recall 12V-305
Reference 2: EA12-005 File Update (Chrysler Jeep Fuel Tank System Safety Defect)

Courtesy Copy List **

Mr. Clarence Ditlow, Director
Center for Auto Safety - Suite 330
1825 Connecticut Ave, NW
Washington, DC 20009-5708
(202) 328-7700

Secretary Ray LaHood
US Department of Transportation
1200 New Jersey Ave, SE
Washington DC 20590
202-366-4000

Mr. Sergio Marchionne, Chairman
Chrysler Group LLC
1000 Chrysler Drive
Auburn Hills MI 48321-8004
248-576-5741

Mr. Courtney E. Morgan, Jr.
Morgan & Meyers, PLLC / Suite 320
3200 Greenfield Road
Dearborn, MI 48120
313-961-0130

Mr. Frank Borris
Office of Defects Investigation, Room W46-302
National Highway Traffic Safety Administration
Washington, DC 20590
202-366-8089

Mr. Larry Hershman
Office of Defects Investigation, Room W48-306
National Highway Traffic Safety Administration
Washington, DC 20590
202-366-4929

Ms. Erika Z. Jones, Esq.
Mayer Brown LLP
1999 K Street, N.W.
Washington, DC 20006-1101
202-263-3000

Mr. Shigeki Terashi, President & COO
Toyota Motor North America, Inc. - Suite 4900
601 Lexington Avenue
New York, NY 10022
212-223-0303

Mr. Christopher P. Reynolds
Group Vice President and General Counsel
Toyota Motor Sales, U.S.A., Inc.
19001 S. Western Avenue
Torrance, CA 90501
310-468-4000

Mr. Réal Tanguay
Senior Managing Officer
c/o Toyota Motor Sales, U.S.A., Inc.
19001 S. Western Avenue
Torrance, CA 90501
310-468-4000

* Available with hyperlinks: <http://links.veronicachapman.com/Sheridan2Strickland-9.pdf>

** By email or USPS

DDM Consultants
22357 Columbia Street
Dearborn, MI 48124-3431
313-277-5095

1 January 2013

VIA FEDEX AIRBILL [8007-9341-5951](tel:8007-9341-5951)

Mr. David L. Strickland, Administrator
NHTSA Headquarters
1200 New Jersey Avenue, SE
Washington, DC 20590
202-366-4000

Subject: Chrysler Group, LLC Failure-to-Warn/Comply under 49 CFR § 573.6, et al. ¹
Reference 1: Toyota Motor Corporation/NHTSA Recall 12V-305 (Public Memo)
Reference 2: EA12-005 File Update (Chrysler Jeep Fuel Tank System Safety Defect)

Dear Mr. Strickland:

Reference 1 affirms that agreement to selected historical facts has occurred between the parties. The memo emphasizes that “a trend” was detected by the Office of Defects Investigation (ODI) by use of Vehicle Owner Questionnaires (VOQ). Reportedly this alerted the agency to the possible existence of a safety defect involving floor mats. Reference 1 does not qualify or quantify the associated product liability litigation activity/behavior. And nowhere does the memo present the injury/death statistics caused by the alleged Toyota safety defect. ^{2 3}

Federal Motor Vehicle Safety Standards (FMVSS) : Comparative Analysis and Discussion

To the best of my knowledge, no FMVSS is directed specifically at floor mats; such a narrow specification is not necessary given the overriding philosophical and regulatory intentions of the National Traffic and Motor Vehicle Safety Act. Likewise, no FMVSS is narrowly directed at the issues germane to EA12-005, specifically:

The intrinsic and foreseeable safety defect of an engineering design that allows for direct collision impact/breach to an unprotected fuel tank system and/or its components. (ATTACHMENT 1) ^{4 5}

The agreement reached between Toyota and NHTSA/DOT portends maximizing the awareness and safety of the public. In this context I am compelled to update EA12-005 with comparative analysis and discussion.

Jeep Vehicle Fire Death/Injury “Trends” Since Not Later Than 1997: Documentation and Events Review

It was known to NHTSA that a trend emerged for severe fire injury and fire death in the Jeep vehicles; one that did not exist in peer vehicles; a trend that was quantitatively and qualitatively far more lethal than what allegedly justified Toyota/NHTSA Recall 12V-305. Historical data indicated that EA12-005 defects had caused 69 deaths within the 1993-1998 ZJ-Body and within the 1999-2004 WJ-Body Jeep Grand Cherokees data bases alone. ⁶

NHTSA was also fully aware that the trend for Jeep Grand Cherokees became non-existent beginning with the 2005 WK-Body; with extensive design input from DaimlerBenz, the WK-Body addressed all failure modes that are known to exist in the defectively designed fuel tank system of the prior Chrysler Jeep Grand Cherokee. ⁷

Review of the following five documents/events confirms that Chrysler Group LLC was fully aware that a severe injury and death trend had emerged, but also that they had foreknowledge that such was foreseeable. Despite these historical facts, spanning over fifteen years, Chrysler failed to warn NHTSA, in clear violation of 49 CFR § 573.6. Further, as I had made you personally aware, they actively sought to conceal internal documentation; a behavior not limited to litigation, but one that confirms that their failure to warn was deliberate.

I. Document: Original Defect Petition of 2 October 2009 - DP09-005

The original defect petition submitted to NHTSA on 2Oct09 by the Center for Auto Safety (CAS) provides overwhelming evidence that Chrysler was aware of an existing defect trend in their 1993-2004 Jeep Grand Cherokees. The following salient observations can be made from the CAS petition:

1. Accidents where the Most Harmful Event (MHE) indicated collision-induced fuel tank related fires were known to Chrysler and NHTSA not later than 1997,
2. Accidents where the MHE resulted from a rear collision-induced fuel tank fire were known to Chrysler by virtue of the fact that such had occurred in Michigan,
3. A majority of the accidents mentioned above, where litigation was commenced, involved not only a safety defect assertion by the plaintiff, but also a “failure to warn” complaint,
4. ALL known litigation mentioned in #3 concluded with Chrysler demanding a “Confidentiality Order.” This fact is called out in the petitioner’s cover letter, but most prominently under his Attachment E. ⁸

A scar in the history of transportation safety, an open assault upon the philosophical intent of the Safety Act, is the dynamic orchestrated by the corporate defense bar under the portent of #4 above: The obscuration of public and Agency knowledge/awareness of a safety defect.

II. Event and Documents: Compliance Status Revision of ZJ-Body - The “Estes Bracket”

FMVSS-301 compliance status of the 1993-1996 ZJ-Body remains highly questionable if not fraudulent. In my letter of 27 August 2012 (Page 5 of 7) I advised you to request from Chrysler Group LLC *“the transcript and exhibits to the deposition of Mr. Judson Estes in Austin v DaimlerChrysler.”* The following salient observation can be made from those documents:

1. Chrysler expects the agency to believe that a minor change to a fuel tank was approved; a change they allege was proposed by a supplier to reduce cost. They expect us to believe that this revision alone caused recertification to FMVSS-301. Legal discovery shows that, at best, FMVSS-301 compliance of the 1993 – 1996 ZJ-Body was/is so incompetent, so marginal, that when certification of essentially a carryover design was attempted, Chrysler was confronted with the likelihood of a non-compliance status for prior sales and existing production. Although no field action was offered, these internal developments had resulted in the unexpected expenditure of hundreds-of-thousands in additional crash testing dollars for the 1997 model year; which then resulted in the last-minute production release a preposterous, make-shift reinforcement to the left rear frame rail, nicknamed the “Estes bracket” (ATTACHMENT 2). Please take the time to read Endnote 9. ⁹

This history should be viewed in the context of Chrysler foreknowledge that, beyond narrow FMVSS-301 compliance, the ZJ-Body fuel system had serious real-world issues that would and did provoke a defect trend.

III. Documents & Event: Compliance Status Revision of WJ-Body - Safety Defect Recall A-10

In my letter to CAS of 1 June 2010, which was copied to you, ¹⁰ I discussed the WJ-Body recall for, what was, once again, a marginal FMVSS-301 compliance status. I made the following assertion:

“What remains significant about this document is that it represents the first time that three key words were used connectedly and simultaneously with respect to the Jeep Grand Cherokee: ‘safety,’ ‘skid plate,’ ‘repaired.’ Although the underlying portent is well-understood internally to Chrysler and its dealers, Safety Recall A10 represented the first admission that Grand Cherokee fuel tank safety/crashworthiness issues could be “repaired” by existence or installation of a skid plate.”

Alternatively, installation of a *“protective impact deflection structure”* (i.e. “skid plate”) resolved not only a narrow non-compliance status, but also the real-world issue of crashworthiness. As you will see in the next section, an existing internal recommendation for a protective structure had already addressed the FEMAs for the fuel systems of the EA12-005 vehicles. These failure modes are implicit to the defect trend in FARS for the Jeep Grand Cherokee. Chrysler Group LLC has been aware of these non-regulated failure modes since not-later than 1978.

IV. Document: Failure to Warn NHTSA: The (Chrysler) Baker “Fuel System Design” Memorandum of 1978

During our face-to-face introduction on 19 May 2010, at the Toyota hearings in the Senate Russell Office Building, I alerted you to the existence of a document that was relevant and responsive to DP09-005.¹¹ In secret, in prior lawsuits, and upon plaintiffs’ capitulation to Chrysler demands for Confidentiality Orders, the 1978 Baker memo was vigorously obscured from public view. In response to your verbal request to receive the Baker memo, I copied you on my 1 June 2010 letter to CAS.¹² In that letter I quoted the Baker memo:

“Where fuel tank location behind the rear axle is all that is feasible, a protective impact deflection structure may have to be provided whether or not a bumper is provided. An investigation whether to relocate the fuel tank or to provide impact deflecting structures is presently underway.” (underline added)

The Baker memo confirms a long-standing foreknowledge of the fact that EA12-005 vehicles, which do not have a “*protective impact deflection structure*,” will provoke a defect trend that will cause horrific injury and death:

1. On 21 August 2000, Mr. Leonard L. Baker was deposed in the litigation of Butler v DaimlerChrysler wherein his memo of 24 August 1978 was examined,
2. On 29 September 2005 Mr. Baker was once-again deposed regarding his memo, this time in the Jeep Grand Cherokee fire death case of Austin v DaimlerChrysler,
3. On 29 May 2003 Chrysler defense expert Mr. Robert Banta was deposed in the ZJ-Body death case of Austin v DaimlerChrysler wherein extensive examination of the Baker memo took place,
4. Both litigations concluded with the obscuration of the existence and content of the Baker memo.

Chrysler Group LLC failed to submit the Baker memo under their obligations to DP09-005 and PE10-031. That I was burdened with its submission to NHTSA affirms that Chrysler actively sought to conceal documentation; a behavior that confirms that their failure to warn was deliberate. (ATTACHMENT 3).¹³

V. Documents & Event: Failure to Warn NHTSA - Chrysler Defense Expert Testimony “*The tank’s on its own.*”

My letter of 24Sep2012 reviews the testimony of the highly qualified Chrysler defense expert Mr. Robert Banta. Referencing photographs that I had forwarded to you on 27Jul2012, Mr. Banta testified (ATTACHMENT 4):

Question: Now, in looking at that photo, can you tell me what part of the vehicle protects the part of the tank that we’re looking at in that photograph?

Witness: *No. It’s covered by the fascia.*

Question: So if a vehicle were to strike just that yellow piece of the car, whether it be because it’s lower or some kind of vehicle that’s not even a car, let’s say it was a recreational vehicle of some sort, what would protect that portion of the tank that we see here in yellow.

Witness: *Just the tank surface itself.*

Question: So in other words, whatever the material of the tank is at the time?

Witness: ***The tank’s on its own.***

Chrysler Group LLC has not alerted NHTSA of this testimony of 7Sep2012. The record now confirms that their own experts agree that the Jeep fuel tank systems identified by EA12-005 only comply with the narrow specifics of FMVSS-301, but cannot protect occupants and bystanders from fire-injury and fire-death in the real-world.¹⁴

Comments Submission to Reference 1 (Toyota/NHTSA Recall 12V-305)

(1) At no time have Toyota executives, defense lawyers or experts involved with Recall 12V-305 offered a paraphrasing of the above Chrysler defense expert testimony, such as: ***“The floor mat’s on its own.”***

(2) At no time have Toyota executives or their defense lawyers involved with Recall 12V-305, or any other safety investigation, sought to engage NHTSA and the Department of Justice (DOJ) in a criminal tripartite effort to obscure critical safety information from the taxpayer.¹⁵

Conclusion Background

This submission offers a ‘comparative analysis and discussion’ between Recall 12V-305 and EA12-005. The former has resulted in a 17.5 million-dollar maximum civil penalty; a first in the history of the Safety Act. During the timeframe when NHTSA was formulating that penalty, the following EA12-005 event occurred:



In early 2012, while NHTSA was detecting “a trend” in Toyota floor mats, I copied you on my letter of 11 April 2012 wherein I declare: *“The details of the fire-death on 6 March 2012 of Remington are too horrific to document.”*¹⁶ [Four-year-old Remington Cole Walden \(pictured at left\) burned to death in a Jeep Grand Cherokee](#). Although he and his aunt both survived the low-speed rear collision, and his aunt was able to escape through the open driver’s side window, the fuel-fed flames that instantly engulfed the Jeep were too intense to save Remington, secured in the rear seat. The aunt and neighbors all watched in horror and helplessness as Remington burned to death in a vehicle that Chrysler notoriously claims *“has an excellent safety record.”*

You and Secretary LaHood received a letter from Mr. Thomas Kline on 31 August 2010. You and Secretary LaHood are aware that Mrs. Kline, wife and mother of two, burned to death on 24 February 2007 in a Jeep Grand Cherokee. You are both in possession of the attachments to the Kline letter, including the autopsy report which documents the lethality of the defective Jeep Grand Cherokee fuel system; a lethality that has taken the lives of 69 American citizens (ATTACHMENT 5). You are in possession of my letter to you of 2Sep2012, which included an eyewitness report that recounts the final *moment* of Mrs. Kline’s life (ATTACHMENT 6).

Conclusion: A Long-known “trend” that was not reported and is not survivable

In the NHTSA press release of 18 December 2012 for Toyota Recall 12V-305 you state (ATTACHMENT 7):

“It is critical to the safety of the driving public that manufacturers report safety defects in a timely manner. Every moment of delay has the potential to lead to deaths or injuries on our nation’s highways.”

I agree with you (and Secretary LaHood). But you must recognize that, in the case of Toyota floor mats, the vast majority of the VOQ database originated with citizens that had survived the defect. In the case of EA12-005, “the trend” was established by those who did *not* survive the defect.

Let us be frank, that in the context of Agency notification requirements, there is no comparison between the historical lethality of 12V-305 and that of EA12-005. It would not be unreasonable for some to allege that Recall 12V-305 was motivated by bias. Given the ‘Documentation and Events’ section above, which is preliminary, I recommend that the Agency formulate EA12-005 actions that obviate any such allegation(s).

Please do not hesitate to contact me at any time.

Respectfully,

Paul V Sheridan

ENDNOTES

¹ Available with active hyperlinks here: <http://links.veronicachapman.com/Sheridan2Strickland-9.pdf>

² Available reports indicate the unfortunate death of one individual which was allegedly caused by the floor mat entrapment defect. Reference 1, the signed NHTSA/Toyota agreement is available here: <http://www.nhtsa.gov/staticfiles/administration/pdf/NHTSA-Toyota-agreement.pdf>

³ You were a courtesy copy recipient of my letter of 11 April 2012. That letter, addressed to National Automobile Dealers Association (NADA) Chairman David Kelleher, made no request of the Agency in the plain direct sense; yet this is the only letter of ten that provoked response. I received a one-page letter from NHTSA dated 26Apr2012 which states:

“We do not have the authority to act on isolated problems or resolve disputes between individual owners, dealers or manufacturers.”

Any credible/integrated reading of my letter to Mr. Kelleher would conclude that no such request, of the kind insinuated by the quote above, was made. The NHTSA letter concludes with:

“The information you provided has been entered into our database. It will be considered with future reports to identify any future safety defect trends that may require our attention.”

Any credible/integrated and sincere reading of my letter would conclude that the past had already demonstrated that a “*safety defect trend*” existed. My Conclusion section contains a request that is very plainly directed at the NADA.

However, with content very similar to the ‘Conclusion Background’ section above, my letter to Mr. Kelleher also contained a section entitled, **The Horrific Fire Death of Four-Year-Old Remington Cole Walden (1999 Jeep Grand Cherokee)**. Presumably this data remains worthy of NHTSA attention.

My letter to NADA of 11Apr2012 is available here: <http://links.veronicachapman.com/Sheridan2Kelleher-1.pdf> As of this letter Mr. Kelleher has not responded.

The NHTSA response letter of 26Apr2012 is available here: <http://links.veronicachapman.com/NHTSA2Sheridan-trend.pdf>

⁴ Please see my letter to you of 27 July 2012; available here: <http://links.veronicachapman.com/Sheridan2Strickland-5.pdf>

⁵ Please see my letter to you of 27 August 2012, Page 2 of 7, first paragraph; available here: <http://links.veronicachapman.com/Sheridan2Strickland-6.pdf>

⁶ EA12-005 was extended to also include the 1993-2001 XJ-Body Jeep Cherokee and the 2001- 2007 KJ-Body Jeep Liberty models, which have a similar fuel system design problem to that of the ZJ/WJ-Body (fuel tank located behind the rear axle and unprotected from direct collision impact on standard equipment models, but with a different fuel filler hose arrangement, etc.). These additional model lines should not be statistically agglomerated with the ZJ/WJ, but as separate and distinct, especially at the level of their respective FEMAs (e.g. the KJ-Body does not have the same fuel tank filler hose FMEA as the ZJ-Body, etc.).

⁷ A majority of the engineering design and a great number of core components of the 2005 WK-Body were provided by the Daimler-Benz engineers during the DaimlerChrysler era; a fact openly touted in Jeep advertisements and press releases. **Contrary to the diversions provided to the media by Chrysler Group LLC, the dramatic improvement in the safety of the fuel tank system of the WK-Body (to that of a ‘no defect’ status versus the ZJ/WJ-Body) had no technical relation to the ruse about “luggage space.”** In litigation and under a competent/complete EA12-005, Chrysler and dealership defense lawyers, their defense experts, **and NHTSA** will be hard-pressed to explain how the inclusion of a 3/16” plate steel fuel tank encapsulation, as standard safety equipment in the WK-Body, has any design correlation whatsoever to “*luggage space*.”

Although Toyota was asked to comment under PE10-031, the fact that NHTSA/ODI failed to solicit comments from DaimlerBenz on the WK-Body and their fuel system engineering design concepts remains egregious. Please see my letter to you of 9Feb2011, Concern 3, on page 4 of 5, available here: <http://links.veronicachapman.com/Sheridan2Strickland-1.pdf>

⁸ The Center for Auto Safety petition is available here: <http://www.autosafety.org/sites/default/files/JeepGrandCherokeeDefectPetition%282%29.pdf>

ENDNOTES CONTINUED

⁹ An expert in the litigation of Kline v Loman's Auto Group et al. has testified, based on Chrysler documentation, that the 1993 – 1996 ZJ-Body compliance for FMVSS-301 is invalid. Years prior to this testimony/report I directed the Kline plaintiff to confront Chrysler Group LLC discovery defense counsel (Miller, Canfield, Paddock & Stone PLC) with the "rear frame rail reinforcement bracket" issue. At first, their lead discovery counselor (M. Sheila Jeffrey) feigned complete ignorance of the question/issue. This is incredulous given that during two full days (26/27 May 2005), in the Jeep Grand Cherokee fire death case of Austin v DaimlerChrysler, the deposition of Mr. Estes had taken place at the law offices of Miller, Canfield, Paddock & Stone PLC. The focus of that two-day deposition, attended by the Chrysler Office of the General Counsel: Recertification of the ZJ-Body for FMVSS-301 by use of the "Estes Bracket." Later, through the plaintiff, I confronted that same discovery counsel/firm with photographs of the "Estes Bracket," as well as the Mopar service part number (52059128AA). At this point defense counsel was forced to acknowledge prior knowledge of the "Estes Bracket" issue. Curiously, immediately following this death case discovery charade, Mopar service part number 52059128AA disappeared from the DirectConnect data base under the guise that the part was suddenly "obsolete."

However, that obsolescence ploy was merely the attempted endpoint. During the time that the "Estes Bracket" was available for service, the Mopar DirectConnect database was misleading the public; declaring that the official purpose of this left rear frame rail reinforcement bracket was not related to ZJ-Body recertification under FMVSS-301, but was listed as a "tail hook." Please review the last two pages of Attachment 2; where you will plainly see that the "Estes Bracket" hooks nothing.

The deposition of plaintiff's expert is available here: <http://links.veronicachapman.com/Hannemann-29Jun12.pdf>

The first day of the deposition of Mr. Estes is available here:

<http://links.veronicachapman.com/DepofJUDSONB.ESTES5-26-2005AustinvDCC.doc>

The second day of the deposition of Mr. Estes is available here:

<http://links.veronicachapman.com/DepofJUDSONB.ESTES5-27-2005AustinvDCC.doc>

If, while I functioned as an Engineering Programs Manager at Chrysler Jeep-Truck Engineering (JTE), an engineer had proposed (for a safety issue and for regular production) the engineering equivalent of something as utterly ludicrous as the "Estes bracket" band aid, I would have proposed retraining and/or unemployment for that engineer.

¹⁰ Available here: <http://links.veronicachapman.com/Sheridan2Ditlow-1.pdf>

¹¹ DP09-005 is available here: http://www-odi.nhtsa.dot.gov/cars/problems/defect/results.cfm?action_number=DP09005&SearchType=QuickSearch&summary=true

¹² Available here: <http://links.veronicachapman.com/Sheridan2Ditlow-1.pdf> Upon conclusion of the Senate hearing (on Toyota) of 19 May 2010, I had a twenty-minute one-on-one meeting with Senator Jay Rockefeller (and his senior staff Jocelyn Moore?). The senator was especially concerned with my discussion of how my office files had been raided and confiscated, including my crashworthiness and FMVSS-301 files, during the Christmas holidays of 1994. I had shared this Rockefeller-Sheridan discussion content via 20 May 2010 email with Mr. Clarence Ditlow, Director at the Center for Auto Safety.

¹³ *Chrysler submissions as late as 13Dec2012, which continue to divert the Agency and the media/public with the notion that "location" is the central complaint of the Petitioner and the current plaintiffs should be shunned as a defense lawyer ruse. It should be emphasized that in August 1978 Chrysler Engineering recognized that although fuel tank location plays a role, the PRIMARY factor in fuel system crashworthiness is protection or, as Mr. Baker specified, use of a "protective impact deflection structure."* Beginning with the WK-Body the Daimler engineers not only relocated the fuel tank to a mid-vehicle location (within and above structural elements, i.e. not exposed to direct collision impact), but also added a "protective impact deflection structure" as standard (i.e. regardless of the on or off-road intentions of the user).

Although Toyota was asked to comment under PE10-031, the fact that NHTSA/ODI failed to solicit comments from DaimlerBenz on the WK-Body and their fuel system engineering design concepts remains egregious. Please see my letter to you of 9Feb2011, Concern 3, on page 4 of 5, available here: <http://links.veronicachapman.com/Sheridan2Strickland-1.pdf>

¹⁴ My letter to you of 24 September 2012 is available here: <http://links.veronicachapman.com/Sheridan2Strickland-8.pdf>

¹⁵ Please see my letter to you of 9Feb2011, beginning with Enclosure 1, PDF page 24 of 245, entitled "Colored Tab," available here: <http://links.veronicachapman.com/Sheridan2Strickland-1.pdf>

¹⁶ See Page Three of Three, letter to Mr. David Kelleher, Chairman of the National Automobile Dealer's Association (NADA), dated 11 April 2012, available here: <http://links.veronicachapman.com/Sheridan2Kelleher-1.pdf> (large file).

ATTACHMENT 1

Mr. David L. Strickland
Administrator
NHTSA Headquarters
1200 New Jersey Avenue, SE
Washington, DC 20590
202-366-4000

1 January 2013

Subject: Chrysler Group, LLC Failure-to-Warn/Comply under 49 CFR § 573.6, et al.

Reference 1: Toyota Motor Corporation/NHTSA Recall 12V-305

Reference 2: EA12-005 File Update (Chrysler Jeep Fuel Tank System Safety Defect)

One Page:

Chrysler Jeep Fuel System Defect Investigation EA12-005

[Print](#)

Defects - Search Results

1 Record(s) Displayed.

Report Date : July 12, 2012 at 09:33 PM

NHTSA Action Number : EA12005

NHTSA Action Number : EA12005

NHTSA Recall Campaign Number : N/A

Vehicle Make / Model:

JEEP / CHEROKEE

JEEP / GRAND CHEROKEE

JEEP / LIBERTY

Model Year(s):

1993-2001

1993-2004

2002-2007

Manufacturer(s) :

CHRYSLER GROUP LLC

Component(s) :

FUEL SYSTEM, GASOLINE:DELIVERY:HOSES, LINES/PIPING, AND FITTINGS

FUEL SYSTEM, GASOLINE:STORAGE

FUEL SYSTEM, GASOLINE:STORAGE:TANK ASSEMBLY

FUEL SYSTEM, GASOLINE:STORAGE:TANK ASSEMBLY:FILLER PIPE AND CAP

Date Investigation Opened : June 12, 2012

Date Investigation Closed : Open

Summary:

NHTSA has conducted extensive analysis of the data regarding fuel tank integrity for the model year (MY) 1993-2004 Jeep Grand Cherokee (JGC). As a result of that work, the agency has decided to upgrade its safety defect investigation to an Engineering Analysis and to expand the scope of vehicles included in the investigation. NHTSA's assessment of the data collected during Preliminary Evaluation (PE) 10-031 indicates that rear-impact-related tank failures and vehicle fires are more prevalent in the JGC than in the non-Jeep peer vehicles. In addition, the agency's analysis of its FARS data for the peer vehicles and three Jeep models shows a higher incidence of rear-impact, fatal fire crashes for the Jeep products. PE10-031 had focused on the fuel tank system integrity of the JGC vehicles during rear-end collisions and impacts. The fuel tank is located at the rear of the vehicle, between the bumper and axle, and is manufactured from a plastic material (HDPE). Three peer vehicles (across the same MY range as the JGC) were identified for comparative assessment: the Chevrolet Blazer, Ford Explorer, and Toyota 4Runner. ODI has collected and assessed a significant volume of data for the JGC and three peer vehicles under the Defect Petition (DP) 09-005 and PE10-031, much of which was either provided by the petitioner or by the subject and peer manufacturers in response to ODI's information request letters. NHTSA has also utilized its FARS database. Fatal crash data was collected for the JGC and its three peers, along with data for two other Jeep vehicles, the Cherokee and Liberty, which were also manufactured with rear mounted fuel tanks and assessed by ODI as Jeep peer vehicles. Based on the agency's current analysis, ODI has upgraded its investigation to determine whether the subject vehicles contain a defect that presents an unreasonable risk to safety. The subject vehicles for the investigation will be MY 1993-2004 JGC, MY 1993-2001 Cherokee, and MY 2002-2007 Liberty. The estimated production volumes for these vehicles are shown above, although attrition is a factor for the older vehicles. Please note that the counts shown in the above failure report summary are for the JGC only (values shown in the total column are unique). Data for the other Jeep models and possibly other peer models will be collected during the investigation. The ODI reports cited above can be reviewed online at www-odi.nhtsa.dot.gov/complaints under the following identification (ODI) numbers: JGC: 506249, 549376, 734783, 869217, 10009553, 10335943, 10351589, 10351980, 10357528. Liberty: 10357195, 10366653 (duplicate of 10357195), 10138726, 10149256, 10181332 Cherokee: 10409104

ATTACHMENT 2

Mr. David L. Strickland
Administrator
NHTSA Headquarters
1200 New Jersey Avenue, SE
Washington, DC 20590
202-366-4000

1 January 2013

Subject: Chrysler Group, LLC Failure-to-Warn/Comply under 49 CFR § 573.6, et al.

Reference 1: Toyota Motor Corporation/NHTSA Recall 12V-305

Reference 2: EA12-005 File Update (Chrysler Jeep Fuel Tank System Safety Defect)

Ten Pages

Photographs of last-minute release of preposterous, make-shift reinforcement to the rear frame rail, nicknamed the “Estes bracket” for the 1997 Jeep Grand Cherokee.

Last page of this attachment shows prior now-deleted MOPAR service graphics page for “Estes Bracket” purposely misleading the public by referring to such as a “*tail hook*.”

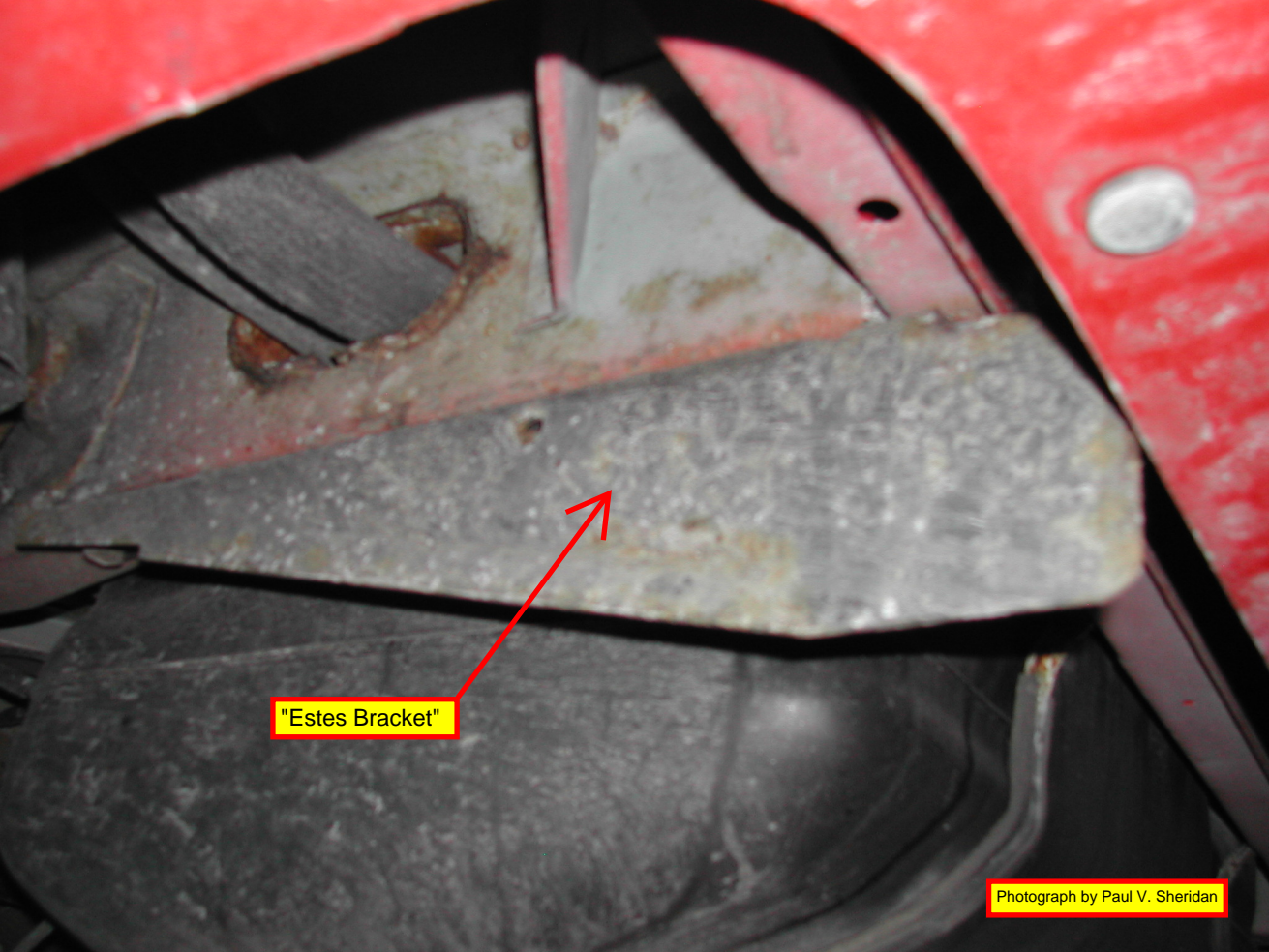

"Estes Bracket"

Photograph by Paul V. Sheridan

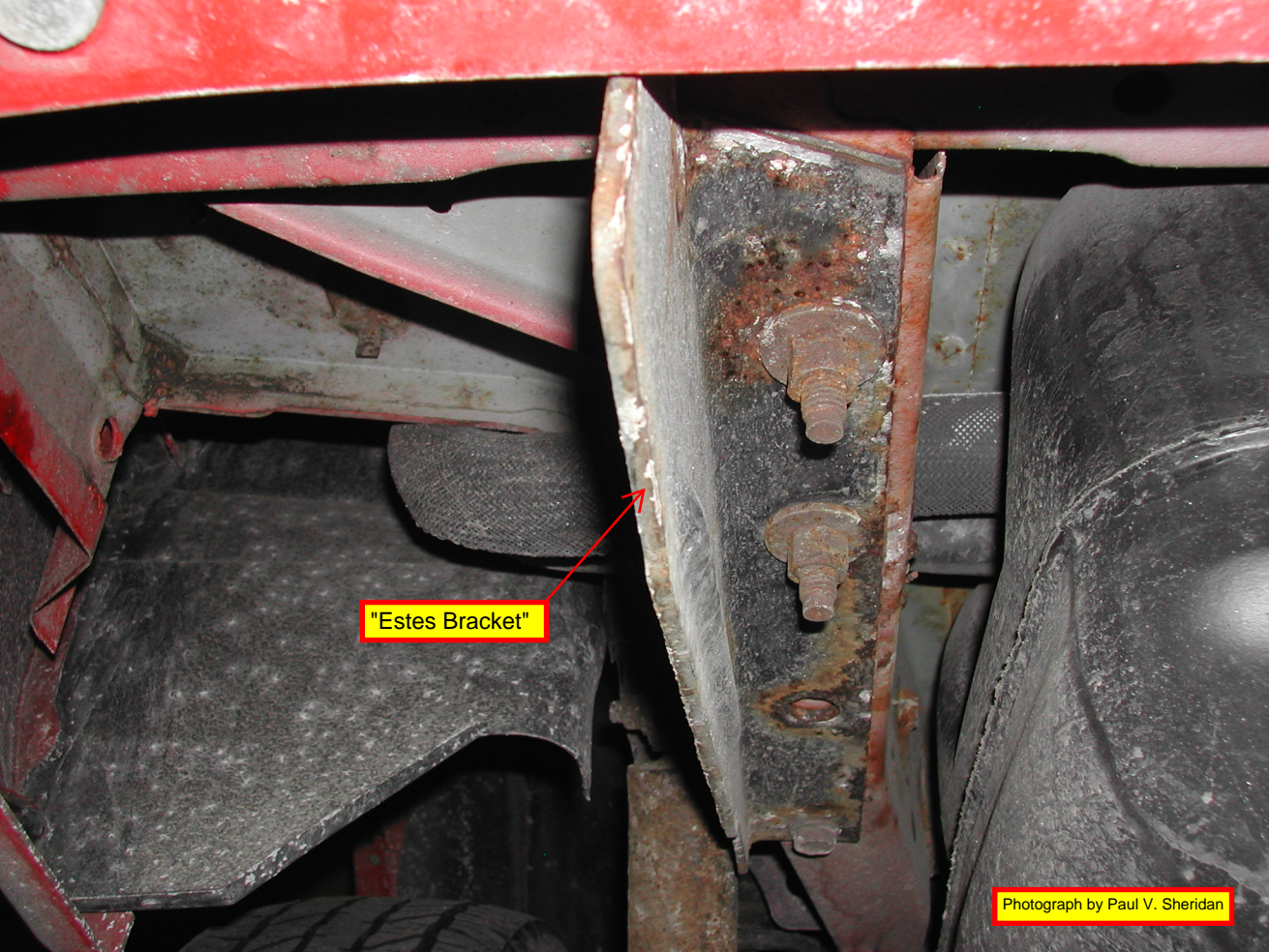

"Estes Bracket"

Photograph by Paul V. Sheridan

A close-up photograph of a heavily rusted metal bracket on a vehicle chassis. The bracket is a vertical plate with a circular hole near the top and a smaller hole near the bottom. It is bolted to a red-painted metal beam. A red arrow points from a yellow box containing the text "Estes Bracket" to the bracket. The surrounding area is dark and shows signs of wear and rust.

"Estes Bracket"

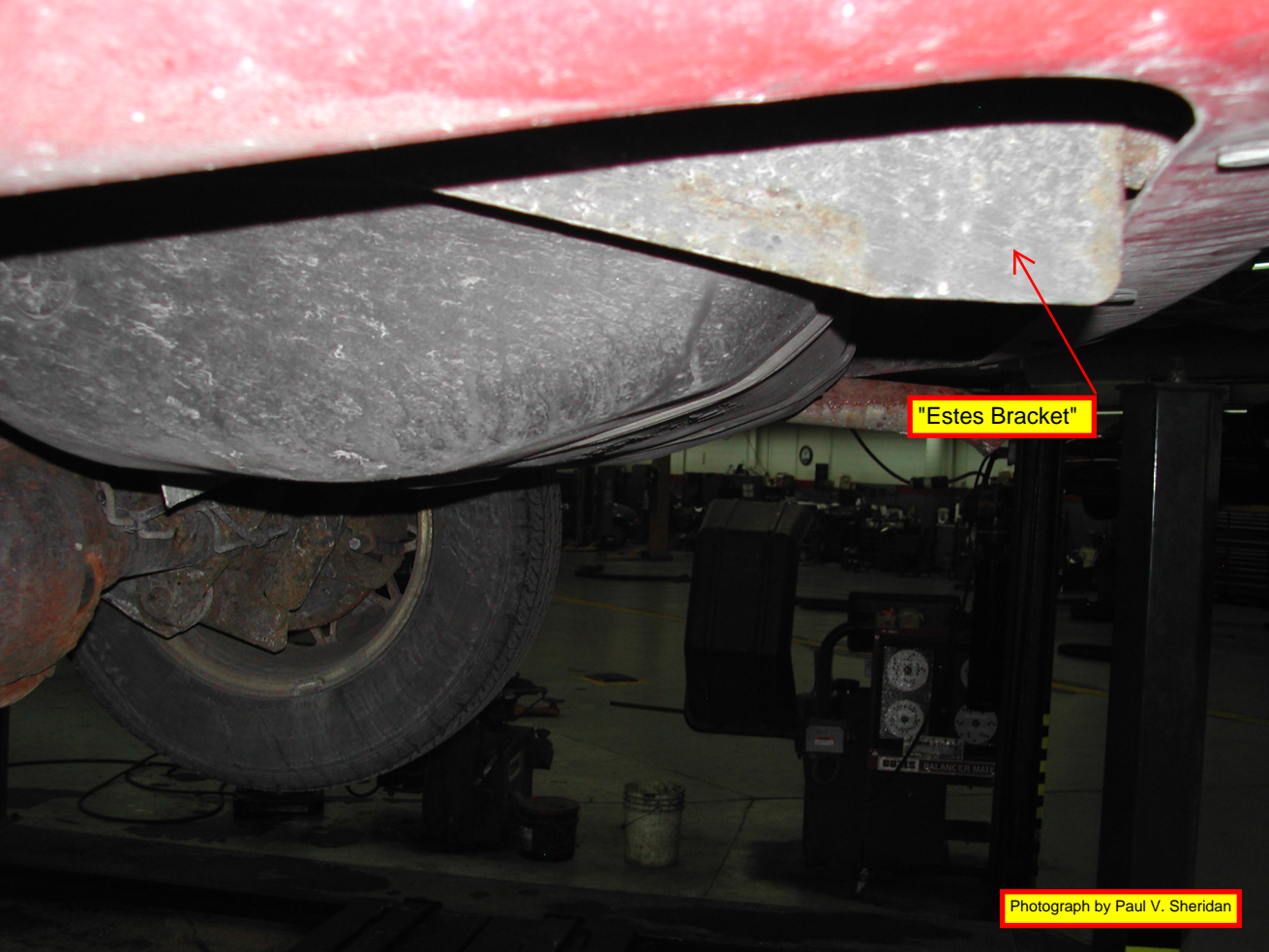

"Estes Bracket"



"Estes Bracket"

Driver's Side View:

Plastic Fuel Tank, mounted behind rear axle, mounted below rear structure and bumper; unlike 2005-current WK-Body, it is unprotected from direct collision impact.



"Estes Bracket"

A close-up photograph of the underside of a red aircraft fuselage. A metal bracket, labeled "Estes Bracket", is mounted to the fuselage. To the right, a grey plastic fuel tank is visible. The background shows a dark workshop or hangar with various equipment and a tire.

Plastic Fuel Tank

Photograph by Paul V. Sheridan



Driver's Side View:

Plastic Fuel Tank, mounted behind rear axle, mounted below rear structure and bumper; unlike 2005-current WK-Body, it is unprotected from direct collision impact.

"Estes Bracket"

Photograph by Paul V. Sheridan

MFD BY CHRYSLER CORPORATION
 DATE OF MFR 6-97
 GVWR 2405 KG(05300 LB)
 GAWR FRONT: 1248 KG(2750 LB) WITH TIRES P225/70R16 RIMS AT 16X7.0 COLD 248 KPA(36 PSI)
 GAWR REAR: 1339 KG(2950 LB) WITH TIRES P225/70R16 RIMS AT 16X7.0 COLD 248 KPA(36 PSI)
 THIS VEHICLE CONFORMS TO ALL APPLICABLE FEDERAL MOTOR VEHICLE SAFETY STANDARDS IN EFFECT ON THE DATE OF MANUFACTURE SHOWN ABOVE.
 VIN: 1J4GZ78S4VC759625 TYPE: MPV SINGLE X DUAL
 MDH: 060619 600 PNT:004 VEHICLE MADE IN U.S.A. TRM:CLAZ 4648503

6-97



1997 ZJ-Body Jeep Grand Cherokee, which had "Estes bracket" installed at factory to ensure certification under the minimums of FMVSS-301.

During the time that the “Estes Bracket” was available for service, the Mopar DirectConnect database ostensibly declared that its official purpose was not related to ZJ-Body recertification under FMVSS-301, but was listed as a “tail hook.”

The “Estes Bracket” hooks nothing.



Pans, Floor
Figure SZJ-210

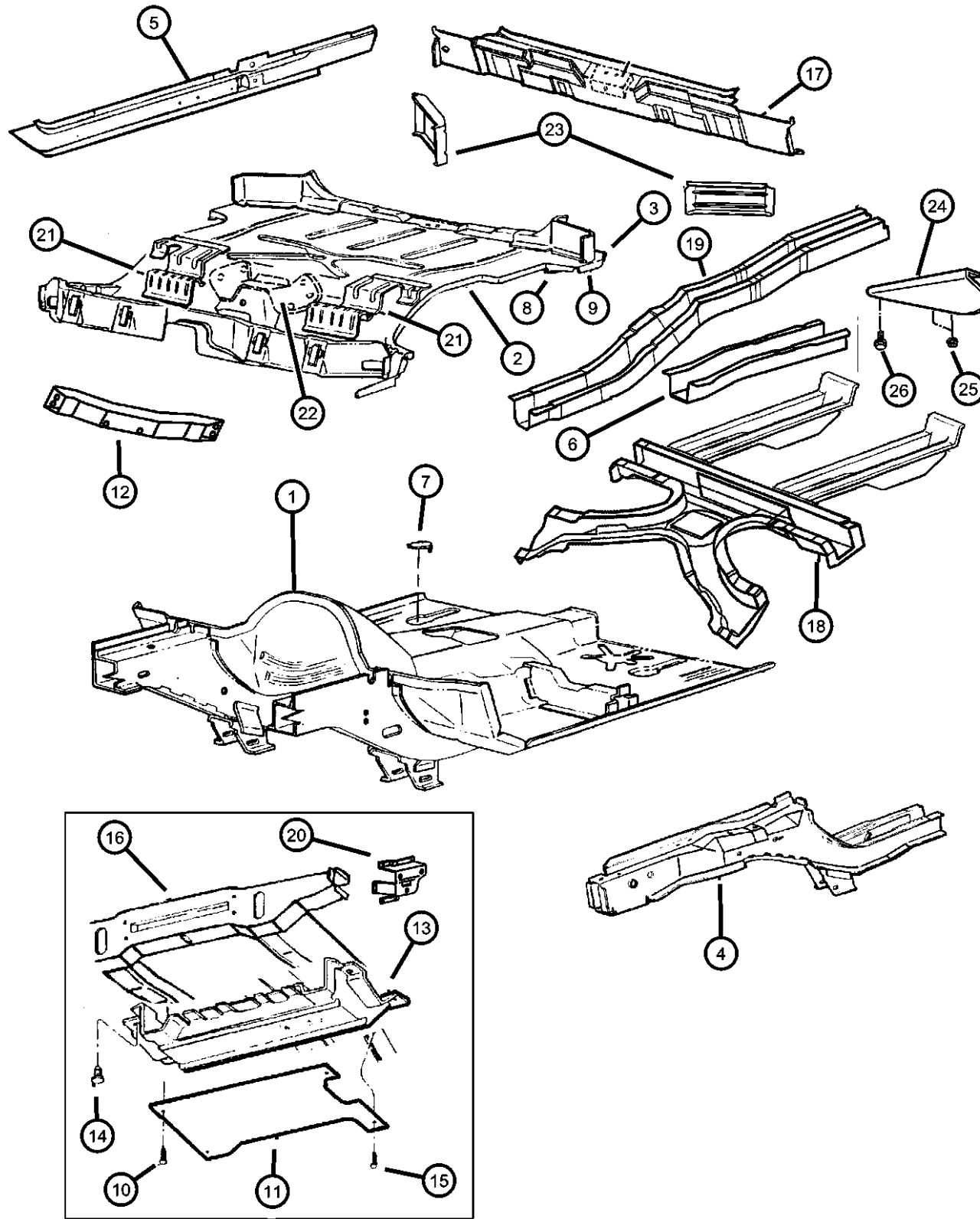

ITEM	PART NUMBER	QTY	LINE	SERIES	BODY	ENGINE	TRANS	TRIM	DESCRIPTION
	55034314	1							Right
	55034315	1							Left
24	52059128AA	1							PLATE, Tow Hook
25	06100056	2							NUT AND WASHER, Hex, M12x1.75
26	06101102	2							BOLT, Hex Head, M12x1.75x45

GRAND CHEROKEE (ZJ)

SERIES LINE
L = LOWLINE T = JEEP - 2WD
J = JEEP - 4WD

BODY
74 = SPORT UTILITY 4-DR

ENGINE
ELF = 5.2L V8 MPI Engine
EML = 5.9L V8 MPI Engine
ERH = 4.0L Power Tech I-6 Engine

TRANSMISSION
DGK = 4-Spd. Automatic 42RE Transmission
DGW = 4-Spd. Automatic 4RE Transmission
DG0 = Transmissions - All Automatic

AR = use ase required - = Non illustrated part

1997 ZJ

ATTACHMENT 3

Mr. David L. Strickland
Administrator
NHTSA Headquarters
1200 New Jersey Avenue, SE
Washington, DC 20590
202-366-4000

1 January 2013

Subject: Chrysler Group, LLC Failure-to-Warn/Comply under 49 CFR § 573.6, et al.

Reference 1: Toyota Motor Corporation/NHTSA Recall 12V-305

Reference 2: EA12-005 File Update (Chrysler Jeep Fuel Tank System Safety Defect)

Two Pages:

Document: Failure to Warn NHTSA:

The (Chrysler) Baker "Fuel System Design" Memorandum of 1978

Inter Company Correspondence

File Code

Date

August 24, 1978

Name & Department	Division	Plant/Office	CIMS Number
R. M. Sinclair, Director International Product Development	Product Plan. & Design Office	Chrysler Center	416-20-15
L. L. Baker, Manager Automotive Safety	Engineering Office	Chrysler Center	418-12-34

Subject: Fuel System Design - Chrysler Passenger Cars And Trucks.

Pursuant to the discussions between Messrs. Vining, Jeffe, Sperlich and yourself with Mr. Mochida on August 22, the fuel system design for domestic passenger cars and trucks is summarized for Mr. Mochida's information.

Not only are the impact performance requirements of MVSS-301 pertinent to the design approach but the significant increase in the last few years in the numbers of product liability cases involving fuel system fires and the increase in the size of the awards by sympathetic juries has to be recognized. In the Ford Pinto case the NHTSA Office of Defects Investigation selected arbitrary performance criteria of minimal or no fuel leakage when the test car is impacted in the rear by a full size car at 35 mph as a basis for questioning the safety of a recall modification of the Pinto.

• Passenger Car

Fuel Tank Location

The front wheel drive configuration in Chrysler's Omni and Horizon allowed the fuel tank to be located beneath the rear seat. This location provides the protection of all of the structure behind the rear wheels--as well as the rear wheels themselves--to protect the tank from being damaged in a collision. This same location will be used in the new 1981 K-Body cars which will also have a front wheel drive.

The rear wheel drive H-Body scheduled for introduction in 1983 will have the fuel tank located over the rear axle and beneath the floor pan.

The question of whether M, R or J-Body cars should be converted to tank over axle prior to their phase-out is a matter under intensive study at this time.

Filler Neck And Cap

As the fuel tank is moved to a more forward location, the fuel fill is moved to the side of the car. The fuel cap will be recessed below the body surface and a fuel fill door provided. The fuel filler neck is designed to break away from the car body with the fuel filler cap still in place.

In this design the filler cap and fill neck or fill tube remain with the tank to avoid separation and possible fuel leakage. This side fill is scheduled for J and M-Bodies in 1980 and the Y-car in 1981.

The fuel fill is less likely to be damaged in a sideswipe when located on the right side of the car. As new models are introduced, the fuel fill will be moved to the right side of the vehicle. This may also offer greater protection to drivers who run out of gasoline on the highway, since they will fill the tank on the side away from the traffic.

Structure

In 1979 through 1983, the M, R, and J model cars which have the fuel tank under the floor pan behind the rear wheels, structural reinforcement of the longitudinals on each side of the tank, shielding of any unfriendly surfaces adjacent to the tank, and the design of straps and hangers to limit undesired tank movement will be employed.

Truck

Fuel Tank Location

The same principles regarding fuel tank location apply to truck design. It is important that these larger fuel tanks are not only shielded from damage in a collision but do not break away from the truck and thereby spread fuel onto the roadway. The approach used by Mitsubishi on the SP-27 of locating the fuel tank ahead of the rear wheels appears to provide good protection for the tank.

The front wheel drive T-115 to be introduced in 1982 will have the fuel tank ahead of the rear wheels and under the rear seat. However, in rear wheel drive trucks there is no clearance over the axle for fuel tank installation and in many cases there is insufficient space ahead of the axle for fuel tanks of the desired capacity.

Chrysler is investigating fuel tank relocation ahead of the rear wheels for vans and multi-purpose vehicles, but present plans for pickups through 1983 and for MPV's and vans through 1985 have the fuel tank located behind the rear wheels. In vehicles both with and without bumpers there is a concern with vertical height differences that create a mismatch with passenger car bumpers. Where fuel tank location behind the rear axle is all that is feasible, a protective impact deflection structure may have to be provided whether or not a bumper is provided. An investigation whether to relocate the fuel tank or to provide impact deflecting structures is presently underway.

Fill Neck And Cap

All trucks and vans have side fill. The sweptline pickup truck (DW 1-3) and multi-purpose vehicles (AD-1 & AW-1) will have a recessed fill cap and fuel filler door beginning in 1981.

L. L. Baker

ATTACHMENT 4

Mr. David L. Strickland
Administrator
NHTSA Headquarters
1200 New Jersey Avenue, SE
Washington, DC 20590
202-366-4000

1 January 2013

Subject: Chrysler Group, LLC Failure-to-Warn/Comply under 49 CFR § 573.6, et al.

Reference 1: Toyota Motor Corporation/NHTSA Recall 12V-305

Reference 2: EA12-005 File Update (Chrysler Jeep Fuel Tank System Safety Defect)

Thirteen Pages:

Five Pages from Chrysler Defense Expert Testimony, previously forwarded to NHTSA on 24 Sep 2012:

“The tank’s on its own.”

Eight Photographs presented to/used in deposition of Chrysler defense expert, previously forwarded to NHTSA on 27 July 2012.

COPY

SUPERIOR COURT OF NEW JERSEY
LAW DIVISION - MORRIS COUNTY
DOCKET NO. MRS-L-3575-08

THOMAS KLINE, AS ADMINISTRATOR
AD PROSEQUENDUM OF THE HEIRS
AT LAW OF SUSAN MORRIS KLINE,
(DECEASED), AS ADMINISTRATOR
OF THE ESTATE OF SUSAN MORRIS
KLINE, AND THOMAS KLINE,
INDIVIDUALLY,

Plaintiff(s),

v.

VICTORIA MORGAN-ALCALA, CARLOS
ALCALA, NATALIE RAWLS, DAIMLER
CHRYSLER CORPORATION, A/K/A
CHRYSLER CORPORATION, LOMAN
AUTO GROUP, BUTLER CHRYSLER,
JEEP, INC., JOHN DOES A THROUGH Z,
(names being fictitious), ABC
CORPORATIONS 1 through 100,
(names being fictitious),

Defendant(s).

-----X

DEPOSITION OF: ROBERT BANTA
Volume II

DATE: September 7, 2012

TIME: 10:10 a.m.

BEFORE: SUSAN DE PALMA, a Notary Public
and Certified Court Reporter
of the State of New Jersey

LOCATION: CALLAHAN & FUSCO, LLC
72 Eagle Rock Avenue
East Hanover, New Jersey 07936

Page 2	Page 4																																																												
<p>APPEARANCES:</p> <p>GRIECO OATES & DE FILIPPO, LLC 414 Eagle Rock Avenue West Orange, New Jersey 07052 BY: ANGEL M. DE FILIPPO, ESQ. and VANESSA FRIEDHOFF, ESQ. Attorneys for the Plaintiff</p> <p>LEARY, BRIDE, TINKER & MORAN, PC 7 Ridgedale Avenue Cedar Knolls, New Jersey 07927 BY: JAMES T. GILL, ESQ. Attorney for the Defendants, Victoria Morgan-Alcala & Carlos Alcala</p> <p>CALLAHAN & FUSCO, LLC 72 Eagle Rock Avenue East Hanover, New Jersey 07936 BY: MARK BRADLEY, ESQ. and LUCINDA J. MC LAUGHLIN, ESQ. Attorneys for the Defendant, Loman Auto Group</p> <p>ALSO PRESENT: PAUL SHERIDAN</p> <p>NO COPY OF THIS TRANSCRIPT MAY BE CONSIDERED CERTIFIED UNLESS SIGNED IN INK BY THE REPORTER LICENSED BY THE STATE OF NEW JERSEY WHO RECORDED THIS MATTER. ANY FACSIMILE MAY HAVE BEEN ALTERED BY MEANS OF ELECTRONIC MEDIA.</p>	<p>EXHIBITS</p> <table border="1"> <thead> <tr> <th>EXHIBIT NO.</th> <th>DESCRIPTION</th> <th>IDENT.</th> </tr> </thead> <tbody> <tr><td>Banta-16</td><td>Technical Report</td><td>12</td></tr> <tr><td>Banta-17</td><td>Amended Technical Report</td><td>12</td></tr> <tr><td>Banta-18</td><td>Supplemental Technical Report</td><td>12</td></tr> <tr><td>Banta-19</td><td>Technical Report 3-24-11</td><td>19</td></tr> <tr><td>Banta-20</td><td>NHTSA EA</td><td>53</td></tr> <tr><td>Banta-21</td><td>NHTSA document dated 5-2-97</td><td>58</td></tr> <tr><td>Banta-22</td><td>Diagram</td><td>92</td></tr> <tr><td>Banta-23</td><td>Photo</td><td>93</td></tr> <tr><td>Banta-24</td><td>Photo</td><td>93</td></tr> <tr><td>Banta-25</td><td>Photo</td><td>115</td></tr> <tr><td>Banta-26</td><td>Photo</td><td>115</td></tr> <tr><td>Banta-27</td><td>Sheridan documents (11 pgs.)</td><td>120</td></tr> <tr><td>Banta-28-33</td><td>Six Photos</td><td>131</td></tr> <tr><td>Banta-34</td><td>Letter dated 10-15-10</td><td>153</td></tr> <tr><td>Banta-35</td><td>15 photos</td><td>180</td></tr> <tr><td>Banta-36</td><td>Vehicle Crash Test Letter</td><td>211</td></tr> <tr><td>Banta-37</td><td>Vehicle Crash Test Request</td><td>219</td></tr> <tr><td>Banta-38</td><td>Vehicle Crash Test Letter</td><td>260</td></tr> <tr><td>Banta-39</td><td>Vehicle Crash Test Letter</td><td>267</td></tr> </tbody> </table>	EXHIBIT NO.	DESCRIPTION	IDENT.	Banta-16	Technical Report	12	Banta-17	Amended Technical Report	12	Banta-18	Supplemental Technical Report	12	Banta-19	Technical Report 3-24-11	19	Banta-20	NHTSA EA	53	Banta-21	NHTSA document dated 5-2-97	58	Banta-22	Diagram	92	Banta-23	Photo	93	Banta-24	Photo	93	Banta-25	Photo	115	Banta-26	Photo	115	Banta-27	Sheridan documents (11 pgs.)	120	Banta-28-33	Six Photos	131	Banta-34	Letter dated 10-15-10	153	Banta-35	15 photos	180	Banta-36	Vehicle Crash Test Letter	211	Banta-37	Vehicle Crash Test Request	219	Banta-38	Vehicle Crash Test Letter	260	Banta-39	Vehicle Crash Test Letter	267
EXHIBIT NO.	DESCRIPTION	IDENT.																																																											
Banta-16	Technical Report	12																																																											
Banta-17	Amended Technical Report	12																																																											
Banta-18	Supplemental Technical Report	12																																																											
Banta-19	Technical Report 3-24-11	19																																																											
Banta-20	NHTSA EA	53																																																											
Banta-21	NHTSA document dated 5-2-97	58																																																											
Banta-22	Diagram	92																																																											
Banta-23	Photo	93																																																											
Banta-24	Photo	93																																																											
Banta-25	Photo	115																																																											
Banta-26	Photo	115																																																											
Banta-27	Sheridan documents (11 pgs.)	120																																																											
Banta-28-33	Six Photos	131																																																											
Banta-34	Letter dated 10-15-10	153																																																											
Banta-35	15 photos	180																																																											
Banta-36	Vehicle Crash Test Letter	211																																																											
Banta-37	Vehicle Crash Test Request	219																																																											
Banta-38	Vehicle Crash Test Letter	260																																																											
Banta-39	Vehicle Crash Test Letter	267																																																											
Page 3	Page 5																																																												
<p>INDEX</p> <p>WITNESS DIRECT CROSS</p> <p>ROBERT BANTA By Ms. De Filippo 6</p>	<p>LITIGATION SUPPORT INDEX</p> <p>REQUEST FOR PRODUCTION OF DOCUMENTS:</p> <p>Page-Line 84, 25 102, 4-8 226, 9 244, 6</p> <p>EXHIBIT ANALYSIS: Exhibits retained by counsel.</p>																																																												

Page 122	Page 124
<p>1 MR. BRADLEY: Just note my 2 continuing objection. 3 THE WITNESS: Yes. 4 Q. And when you look at this 5 photograph, does it appear to you to be -- 6 well, let me ask you this. 7 Did you have an opportunity 8 during the pendency of this case, and I 9 think you've indicated such in your 10 reports, to look at the CARCO testing that 11 was done to Jeep Grand Cherokee? 12 A. Yes, I looked at that. 13 Q. And when you look at the second 14 photograph that is in this packet, does it 15 look to be the vehicle from the CARCO 16 45-mile an hour test? 17 MR. BRADLEY: If you know. 18 Q. If you can recall. 19 A. Yes. 20 Q. If you look at that photograph 21 and you look at the car itself, can you 22 identify the tank in that car? 23 MR. BRADLEY: As depicted in the 24 photograph? 25 MS. DE FILIPPO: Yes.</p>	<p>1 A. I think -- 2 MR. BRADLEY: It's not very clear. 3 THE WITNESS: I think it's more. 4 Q. You think it's more than 5 17 inches from the ground? 6 A. Yeah. Maybe close to 20. 7 MR. BRADLEY: Just note my 8 objection. 9 THE WITNESS: The bottom surface 10 of the floor tank? 11 Q. The bottom surface, yes. 12 MR. BRADLEY: Just note my 13 objection. I don't see how this has 14 anything to do with his expert report and 15 it's beyond the scope of his expert -- 16 MS. DE FILIPPO: Fine. 17 MR. BRADLEY: You can answer. 18 Q. You can answer. 19 A. Yeah, I think that's about right, 20 17 or 18. 21 Q. So now the -- can you tell by 22 looking at the photograph whether this 23 Jeep Grand Cherokee is in the same 24 configuration as the Kline vehicle? 25 MR. BRADLEY: Just note my</p>
Page 123	Page 125
<p>1 THE WITNESS: Identify the what? 2 Q. The gas tank. 3 A. Yes. It's painted yellow. 4 Q. So the item on the car underneath 5 the bumper which is painted yellow and has 6 two straps on either side of it, that's 7 the gas tank. Correct? 8 A. Yes. 9 Q. In the third photograph are you 10 able to identify that vehicle as a Jeep 11 Grand Cherokee? 12 A. Yes. 13 Q. Is it a ZJ? 14 A. Yeah. 15 Q. And when you look at that 16 photograph you see that there's a 17 yardstick in that photograph but behind 18 that yardstick is the gas tank depicted? 19 A. Yes. 20 Q. And is the gas tank, although 21 it's not painted yellow, the structure 22 which is approximately 17 inches from the 23 ground as per that yardstick? 24 MR. BRADLEY: If you can tell. 25 Q. A little less than 17.</p>	<p>1 continuing objection. 2 THE WITNESS: Well, it's the same 3 type of vehicle. 4 Q. And is there anything which 5 encompasses the tank as you look at the 6 photograph which we have previously marked 7 as Banta-23 that you are looking at right 8 now, the same one you're looking at? 9 MR. BRADLEY: Can you repeat that 10 question? I don't understand it. 11 Q. Is there any part of the vehicle 12 which is covering, shielding the tank as 13 you look at it depicted in Banta-23? 14 MR. BRADLEY: Just note my 15 objection. This is called an exemplar 16 vehicle. 17 THE WITNESS: No, nothing covers 18 the tank. You mean the bottom and rear 19 surfaces? 20 Q. Right. 21 A. Other than the vehicle structure? 22 Q. Right. Go to the next photograph 23 which is the side view of the Jeep Grand 24 Cherokee. Correct? 25 A. Yes. Of this Grand Cherokee,</p>

Page 126

1 yes.
 2 Q. And can you see the tank in that
 3 photograph?
 4 A. Yes.
 5 Q. And about how much of that tank
 6 hangs below the vehicle structure?
 7 MR. BRADLEY: Just note my
 8 objection.
 9 Q. Based on what you can see in that
 10 photograph.
 11 A. Oh, maybe about seven inches in
 12 this photograph.
 13 Q. And is there anything -- when you
 14 look at that tank depicted in this
 15 photograph, can you tell what material
 16 that tank is made of?
 17 MR. BRADLEY: If you know.
 18 THE WITNESS: Yes.
 19 Q. What is it?
 20 A. It's high density polyethylene.
 21 Q. And is that the same substance
 22 that the Susan Kline tank was made of?
 23 A. Let me go back and re-answer.
 24 The typical material is high density
 25 polyethylene, at least that's what Susan

Page 127

1 Kline had.
 2 Q. Okay.
 3 A. This vehicle appears to have a
 4 production fuel tank and if it's a
 5 production tank, it was also high density
 6 polyethylene.
 7 Q. So it looks like what would have
 8 been the tank in the Susan Kline vehicle?
 9 A. Yes.
 10 Q. If you look at the next
 11 photograph, is that the side frame rail?
 12 A. The left side rail, yes.
 13 Q. It's the left side rail?
 14 A. This vehicle had either a trailer
 15 tow or skid plate on it at one time.
 16 Q. Okay. But when you look at the
 17 side rail -- is the side rail depicted?
 18 Is that the piece of metal that has an
 19 oval hole through it?
 20 A. Yeah, the pass-through?
 21 Q. Yes.
 22 A. Yes.
 23 Q. When you look at this photograph,
 24 the oval hole is kind of rusty. Right?
 25 MR. BRADLEY: Just note my

Page 128

1 objection.
 2 Q. In the photograph.
 3 A. Yes.
 4 Q. I'm just trying to identify what
 5 we're looking at. Is that the hole that
 6 the filler hose passes through to get from
 7 the place where you put the gas into the
 8 car to the tank?
 9 A. Yes.
 10 Q. And if you look at the next
 11 photograph, you've already seen this
 12 photograph, Banta-24. That would be the
 13 bumper that we talked about earlier.
 14 Correct?
 15 A. Yes.
 16 Q. And that's a similar bumper to
 17 what the Susan Kline vehicle would have?
 18 MR. BRADLEY: Just note my
 19 objection.
 20 THE WITNESS: Yes.
 21 Q. And then finally, the last
 22 photograph in this is a photograph of --
 23 well, you tell me if you can indicate
 24 what's depicted on the last photograph.
 25 MR. BRADLEY: Just note my

Page 129

1 objection. I don't know what it depicts
 2 and I don't see how it's relevant and it's
 3 beyond the scope of his expert report.
 4 MS. DE FILIPPO: Fine.
 5 MR. BRADLEY: You can answer if
 6 you know what's depicted.
 7 THE WITNESS: This is a post
 8 crash photograph done by CARCO after this
 9 vehicle was hit in the rear by a bullet
 10 vehicle at 40 miles an hour.
 11 Q. You've seen this before.
 12 Correct?
 13 A. I think I have, yeah.
 14 Q. Okay. And --
 15 A. I think I saw this in black and
 16 white. I've not seen a nice one like this
 17 before.
 18 Q. I'm sorry, I represented that was
 19 the last photo. There's one more.
 20 The next photograph is -- can you
 21 tell me what that is?
 22 A. That's the same vehicle with a
 23 different view and it appears that in this
 24 test this fuel tank was leaking not
 25 gasoline but some solvent.

1 Q. Is that stoddard?
 2 MR. BRADLEY: If you know.
 3 THE WITNESS: Probably.
 4 Q. Mr. Banta, if you would look at
 5 the photographs, whichever you prefer,
 6 either photograph number 2, 3 or 4 in this
 7 packet, or any that you need to look at,
 8 and would you indicate to me or show me on
 9 any of the photographs what protected the
 10 portion of the tank that's hanging below
 11 the bumper?
 12 A. The tank --
 13 MR. BRADLEY: Just note my
 14 continuing objection as this is not
 15 necessarily depictive of the Susan Kline
 16 subject vehicle. Are you asking what
 17 protected it in this vehicle as depicted,
 18 in the Susan Kline vehicle, any vehicle?
 19 MS. DE FILIPPO: I note your
 20 objection. But he didn't ask me that
 21 question. So he can answer if he
 22 understands my question.
 23 MR. BRADLEY: If you understand
 24 the question, you can answer.
 25 THE WITNESS: If we look at this

1 A. Yes.
 2 Q. Now, in looking at that photo,
 3 can you tell me what part of the vehicle
 4 protects the part of the tank that we're
 5 looking at in that photograph?
 6 A. No. It's covered by fascia
 7 material.
 8 Q. So if a vehicle were to strike
 9 just that yellow piece of the car, whether
 10 it be because it's lower or some kind of
 11 vehicle that's not even a car, let's say
 12 it was a recreational vehicle of some
 13 sort, what would protect that portion of
 14 the tank that we see here in yellow?
 15 MR. BRADLEY: Just note my
 16 objection.
 17 THE WITNESS: Just the tank
 18 surface itself.
 19 Q. So in other words, whatever the
 20 material of the tank is at the time?
 21 A. The tanks on its own.
 22 Q. Now if you look at the next
 23 photograph, which we marked Banta-23,
 24 where the bumper has been removed, is the
 25 crossmember depicted in that photograph,

1 photograph --
 2 MS. DE FILIPPO: Why don't we mark
 3 -- I'm thinking we ought to mark all the
 4 photographs so we know what we're looking
 5 at. So let's mark from the beginning to
 6 end with the exception of the ones
 7 previously marked.
 8
 9 (Six photographs are received and
 10 marked Banta-28 through Banta-33 for
 11 identification.)
 12
 13 Q. Let's just start with photograph
 14 which I have marked Banta-29. Would you
 15 look at that photograph, Mr. Banta, this
 16 one?
 17 A. Okay.
 18 Q. You've already testified that
 19 that depicts the back of the CARCO Jeep
 20 Grand Cherokee prior to being stuck.
 21 Correct?
 22 A. Yes.
 23 Q. And you've already indicated that
 24 what's yellow in the bottom of the bumper
 25 is the gas tank. Correct?

1 Banta-23?
 2 A. Yes.
 3 Q. It is?
 4 A. Yes, the rear crossmember.
 5 Q. So the rear crossmember, that is
 6 the piece of equipment that you indicated
 7 previously protects the tank. Correct?
 8 A. No. The rear crossmember and the
 9 bumper both. They're both back there and
 10 they're tied together.
 11 Q. So with the bumper off are you
 12 saying that the rear crossmember doesn't
 13 protect the tank?
 14 MR. BRADLEY: Just note my
 15 objection. I believe he testified before
 16 there was a box that protected the tank.
 17 THE WITNESS: They're in
 18 combination.
 19 Q. I'm saying with the bumper off as
 20 you see it here in Banta-23, are you
 21 indicating there's no protection for any
 22 part of that tank?
 23 A. Well, I guess --
 24 MR. BRADLEY: From what?
 25 THE WITNESS: There is protection

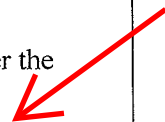

**ZJ-Body Jeep Grand Cherokee:
Typical Customer View (of Fuel Tank)**



**ZJ-Body Jeep Grand Cherokee:
What Showroom Customer Would See if
Fuel Tank was not color-matched to rear
underbody / rear suspension components.**



Photograph by Karco Engineering



Approximate Lower Edge of "bumper," leaving over seven inches of fuel tank unprotected from direct or underride impact.

Open-ended frame rail where bumper bracket is inserted for mounting.

Unprotected Polyethylene fuel tank



Tire Size: LT235/75R15

Upper edge of "structure" at approximately 21.25 inches, which leaves over 7 inches of unprotected fuel tank; unprotected from/during up to 270 degrees of impact angles.

Approximate Lower edge of bumper

Distorted slightly by camera angle, lower portion of polyethylene fuel tank (for this vehicle) at approximately 14 inches above ground (when vehicle suspension is not burdened).

ZJ-Body Rear Fuel Tank Fill
Layout Underside View : fuel tank
removed.

Frame Rail Hole for Fuel Tank Filler / Vent
Hose for pass-through to Fuel Tank.

Left Side (inner surface) of Driver's Side Rear RIM Fascia.

Photograph by Karco Engineering



ZJ-Body Rear
Bumper / RIM
Fascia System

Rear RIM Fascia:
Zero protection to
angular impacts.

Rear Bumper: Not IIHS Certified
to Minimal 2.5 MPH (?);
Note lightening holes.

Bumper Bracket: Non-EAU inserted
into Open Frame Rail for Mounting

**ZJ-Body Rear "Structure" / Bumper
Fuel Tank Protection Performance
Post Real World 40mph Impact.**

Rear Bumper with lightening holes. High location of lower edge does not provide any direct impact protection for lower 7+ inches of polyethylene fuel tank. RIM Fascia covering exacerbates false impression of crash protection.



Photograph by Karco Engineering



**ZJ-Body Jeep Grand Cherokee Unprotected Fuel Tank System
Real World Performance of Rear "Structure" and Bumper :
Post 40mph impact test.**

ATTACHMENT 5

Mr. David L. Strickland
Administrator
NHTSA Headquarters
1200 New Jersey Avenue, SE
Washington, DC 20590
202-366-4000

1 January 2013

Subject: Chrysler Group, LLC Failure-to-Warn/Comply under 49 CFR § 573.6, et al.

Reference 1: Toyota Motor Corporation/NHTSA Recall 12V-305

Reference 2: EA12-005 File Update (Chrysler Jeep Fuel Tank System Safety Defect)

Seven Pages:

Original letter from Mr. Thomas Kline, forwarded to NHTSA/DOT on 31 August 2010, includes:

The autopsy report of 9 August 2010 for the Jeep Grand Cherokee fire-death of Mrs. Susan Kline,

The Chrysler-Baker memo of 24 August 1978.

August 31, 2010

Honorable David L. Strickland, Administrator
NHTSA
Headquarters/West Building
1200 New Jersey Ave. SE
Washington, DC 20590

Honorable Ray LaHood, Secretary
United States Department of Transportation
1200 New Jersey Ave. SE
Washington, DC 20590

Senator Frank Lautenberg
324 Hart Senate Office Bldg.
Washington, DC 20510-3003

Mr. Clarence Ditlow
Center for Auto Safety
Suite 330
1825 Connecticut Avenue NW
Washington, DC 20009-5708

Dear Sirs:

The recent media reports of the Federal Government's investigation of the Chrysler Jeep Grand Cherokee have come to my attention. I am the surviving spouse of a victim of a post-collision fuel tank fire/explosion.

My wife, Susan, was travelling on a New Jersey highway and was struck in the rear while driving a Jeep Grand Cherokee. Upon impact, the rear of the Jeep where the gas tank was located immediately burst into flames. As you can see from the attached doctor's letter, my wife suffered horribly as she burned to death.

The purpose of this letter is to offer my assistance to this investigation. At the time of my wife's death, in addition to the 1996 Jeep Grand Cherokee she was driving, we owned a 2003 Jeep Grand Cherokee. This vehicle has remained in my garage since her death because I will not sell or permit it to be resold to another potentially

unfortunate family who is unaware of the fact that the Jeep Grand Cherokee was designed with an unprotected fuel tank located in the most vulnerable position behind the axle and below the bumper.

Since Susan's death, I have obtained information which exposes Chrysler's knowledge of fuel system fires caused by fuel tank locations behind the axle. Chrysler knew their cars were dangerous well before Susan's death. I am enclosing the 1978 memo authored by L.L. Baker, Chrysler's manager of automotive safety. A careful reading of this memorandum also reveals that at the very least, "...a protective impact deflection structure may have to be provided..."

As the 1978 Baker memorandum states, "An investigation whether to relocate the fuel tank or provide impact deflecting structures is presently underway."

The Jeep that Susan was driving in 2007 at the time of her death had a plastic fuel tank located behind the axle and no protection whatsoever, including no impact deflecting structure. We now know that Susan's horrendous suffering and death was entirely preventable.

If my 2003 Jeep Grand Cherokee is needed for inspections or testing, including crash testing, my family would be willing to donate this vehicle.

If you wish to know any further details about Susan's collision or the ongoing litigation please contact my attorney, Angel M. DeFilippo at Grieco, Oates & DeFilippo, LLC, 414 Eagle Rock Avenue, Suite 200, West Orange, NJ 07052, (973) 243-2099.

Again, my intent is to assist you in preventing another family from suffering the grief and losses that we continue to experience

Very truly yours,



Thomas Kline

cc: Angel M. DeFilippo, Esq.
Paul V. Sheridan

Ross I.S. Zbar, MD, FACS

Diplomate of the American Board of Plastic Surgery
Member, American Society of Plastic Surgery
Fellow, Cleft Palate Craniofacial Association
Fellow, American College of Surgeons

Plastic and Reconstructive Surgery

August 09, 2010

Angel DeFilippo
Grieco, Oates & DeFilippo, LLC
414 Eagle Rock Avenue, Suite 200
West Orange, NJ 07052

Dear Ms DeFilippo,

Re: Susan Morris

This report is authored after review of the following documents which were supplied by your office: County of Morris Office of Medical Examiner Autopsy Report for Susan Morris; Forensic Dental Exam; Death Certificate; Police Report; Witness statement of Peter Moodie and; photographs.

There are particularly disturbing findings in the autopsy report indicating that Ms Morris was alive and conscious immediately following the motor vehicle accident (MVA) which resulted in the explosion of her automobile.

On page four of the State Police report filed by Trooper 6598, it is noted that Ms Morris (vehicle #2) was found "laying across the front passenger seat." Either she could have been: (1) thrown following the impact unconscious versus dead or; (2) electively tried to escape her burning automobile. Both the physics of a rear end impact and review of the photographs clearly underscore the latter as the likely scenario.

The autopsy report notes a carboxyhemoglobin level (COHb) of only 29 as measured by NMS.labs. Fire releases carbon monoxide (CO) which is bound by the hemoglobin in red blood cells in lieu of oxygen. Mental and muscular deterioration generally occur at a COHb level of 30 or greater. This means that Ms Morris was indeed actively breathing after the fire started (ie - she inhaled CO and was alive). Furthermore, when she stopped breathing (ie - died), her COHb was not so elevated that she slipped into an unconscious state and slowly suffocated, thus elevating her COHb level even higher. Rather her thermal injuries were so extensive that she most likely died from these and subsequently stopped breathing. Based on her COHb level, she was not given the opportunity to "slip into unconsciousness" but rather was "cooked alive."

200 Highland Avenue Glen Ridge, New Jersey 07028

TEL: (973) 743-4800

FAX: (973) 743-3111

Ross I.S. Zbar, MD, FACS

Diplomate of the American Board of Plastic Surgery

Member, American Society of Plastic Surgery

Fellow, Cleft Palate Craniofacial Association

Fellow, American College of Surgeons

Plastic and Reconstructive Surgery

Page 2 of 3: Morris

There is no evidence in the autopsy report of any other organ injury, but for thermal damage and its sequela. The blunt trauma to the chest with "undisplaced rib fractures" [sic] is of no consequence.

Further evidence of her breathing after impact is supplied by soot deposition in her larynx and trachea as well as her lungs. The autopsy report notes "severe hyperemia" and "congestion" – evidence of the body's reaction to breathing noxious fumes into the delicate internal lining of the body's respiratory system. Responses to these unpleasant foreign bodies include severe and spasmodic coughing and eye irritation.

The heat fractures in the extremities as described in the autopsy report are a result of such high temperatures that the muscle shrinks as it is cooked and pulls at the bony insertions while the outer cortex of bone is weakened from thermal injury. The heat fractures in the skull are a result of increased intracranial pressure as the escaping steam from the cooked brain blows out the calvarial bones. Heat amputations of digits which are described in the report are a result of such high temperature that the skin, muscle, tendons and bone are simply carbonized and turned into dust. Fortunately, these terribly tragic events were completed after Ms Morris' death, however; these certainly started before she died. When combined with the COHb level indicating definite but not terminal CO exposure, the proximate cause of death even more so is likely thermal injury.

Thermal injury is well known as perhaps the most painful injury from which to recover. ~~The pain is caused by raw exposure of nerves to environmental stimuli (due to absence of skin/soft tissue).~~ Even light touch can be horribly painful. Any person who has experienced a first or second degree burn can attest to the severe pain which results. The medical literature is replete with manuscripts describing medical management of these suffering patients. As the burn becomes deeper (third and fourth degree), ironically the pain decreases since the nerves which propagate the signal to the brain are themselves eliminated by the thermal injury. Simply stated, the pain is well known as excruciating.

200 Highland Avenue Glen Ridge, New Jersey 07028

TEL: (973) 743-4800

FAX: (973) 743-3111

Ross I.S. Zbar, MD, FACS

Diplomate of the American Board of Plastic Surgery
Member, American Society of Plastic Surgery
Fellow, Cleft Palate Craniofacial Association
Fellow, American College of Surgeons

Plastic and Reconstructive Surgery

Page 3 of 3: Morris

The burns that Ms Morris suffered went through an evolution. There was both direct flame as well as heat injury. Her entire body was exposed to all stages of burn – progressing from first through fourth degree burns. These finally became so severe that heat fractures occurred. There is no way to know exactly when she died, but she certainly was exposed to severe pain.

Since she was conscious following this MVA, the fear and knowledge of imminent death is another critical factor in perception of pain. Once again, the medical literature is replete with studies documenting how anxiety increases the level of pain experienced.

In summary, the autopsy report provides evidence that Ms Morris was conscious after impact; moved to the passenger seat in order to attempt escape; and died as a result of acute thermal injury. She did not suffer any other injuries that would indicate she was unconscious or thrown out of the driver's seat at the time of impact. Moreover, the physics of a rear impact would not produce a scenario where she could be thrown into the passenger's seat. Rather it is most likely that Ms Morris was conscious after her car was hit. With flames lapping throughout the vehicle, she climbed into the passenger seat trying to escape immolation. She suffered direct pain from flames and heat as her skin melted away. The first and second degree burns throughout her entire body would be excruciatingly painful. She would be racked by coughing due to the soot and her eyes would be tearing excessively as well. Since she was presumably conscious, her anxiety would actually increase the severity of her pain and the horrific nature of her situation. A reasonable estimate would be that she was alive for perhaps three to five minutes. Death was a merciful escape.

References:

Laterjet J and Choinere M. Pain in Burn Patients. Burns 1995 (21); 344.

Perry S, Heidrich G and Ramos E. Assessment of Pain by Burn Patients. J of Burn Care and Rehabilitation. 1981 (2); 322.

Ploghaus A et al. Exacerbation of Pain by Anxiety is Associated with Activity in a Hippocampal Network. J Neuroscience. 2001 (21); 9896.

Shkrum M and Ramsay D. Forensic Pathology of Trauma. 2007 Humana Press, Totowa, NJ 07512.

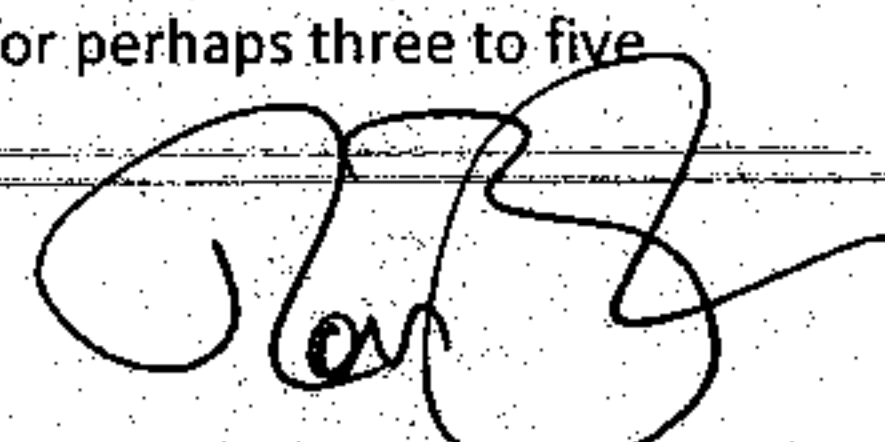

200 Highland Avenue Glen Ridge, New Jersey 07028

TEL: (973) 743-4800

FAX: (973) 743-3111

Inter Company Correspondence

File Code

Date

August 24, 1978

From - Name & Department	Division	Plant/Office	CINAS Number
R. M. Sinclair, Director International Product Development	Product Plan. & Design Office	Chrysler Center	416-20-15
L. L. Baker, Manager Automotive Safety	Engineering Office	Chrysler Center	418-12-34

Subject: Fuel System Design - Chrysler Passenger Cars And Trucks.

Pursuant to the discussions between Messrs. Vining, Jaffe, Sperlich and yourself with Mr. Mochida on August 22, the fuel system design for domestic passenger cars and trucks is summarized for Mr. Mochida's information.

Not only are the impact performance requirements of MVSS-301 pertinent to the design approach but the significant increase in the last few years in the numbers of product liability cases involving fuel system fires and the increase in the size of the awards by sympathetic juries has to be recognized. In the Ford Pinto case the NHTSA Office of Defects Investigation selected arbitrary performance criteria of minimal or no fuel leakage when the test car is impacted in the rear by a full size car at 35 mph as a basis for questioning the safety of a recall modification of the Pinto.

Passenger Car

Fuel Tank Location

The front wheel drive configuration in Chrysler's Omni and Horizon allowed the fuel tank to be located beneath the rear seat. This location provides the protection of all of the structure behind the rear wheels—as well as the rear wheels themselves—to protect the tank from being damaged in a collision. This same location will be used in the new 1981 K-Body cars which will also have a front wheel drive.

The rear wheel drive H-Body scheduled for introduction in 1983 will have the fuel tank located over the rear axle and beneath the floor pan.

The question of whether M, R or J-Body cars should be converted to tank over axle prior to their phase-out is a matter under intensive study at this time.

Filler Neck And Cap

As the fuel tank is moved to a more forward location, the fuel fill is moved to the side of the car. The fuel cap will be recessed below the body surface and a fuel fill door provided. The fuel filler neck is designed to break away from the car body with the fuel filler cap still in place.

In this design the filler cap and fill neck or fill tube remain with the tank to avoid separation and possible fuel leakage. This side fill is scheduled for J and M-Bodies in 1980 and the Y-car in 1981.

The fuel fill is less likely to be damaged in a sideswipe when located on the right side of the car. As new models are introduced, the fuel fill will be moved to the right side of the vehicle. This may also offer greater protection to drivers who run out of gasoline on the highway, since they will fill the tank on the side away from the traffic.

Structure

In 1979 through 1983, the M, R, and J model cars which have the fuel tank under the floor pan behind the rear wheels, structural reinforcement of the longitudinals on each side of the tank, shielding of any unfriendly surfaces adjacent to the tank, and the design of straps and hangers to limit undesired tank movement will be employed.

Truck

Fuel Tank Location

The same principles regarding fuel tank location apply to truck design. It is important that these larger fuel tanks are not only shielded from damage in a collision but do not break away from the truck and thereby spread fuel onto the roadway. The approach used by Mitsubishi on the SP-27 of locating the fuel tank ahead of the rear wheels appears to provide good protection for the tank.

The front wheel drive T-115 to be introduced in 1982 will have the fuel tank ahead of the rear wheels and under the rear seat. However, in rear wheel drive trucks there is no clearance over the axle for fuel tank installation and in many cases there is insufficient space ahead of the axle for fuel tanks of the desired capacity.

Chrysler is investigating fuel tank relocation ahead of the rear wheels for vans and multi-purpose vehicles, but present plans for pickups through 1983 and for MPV's and vans through 1985 have the fuel tank located behind the rear wheels. ~~In vehicles both with and without bumpers there is a concern with vertical height differences that create a mismatch with passenger car bumpers.~~ Where fuel tank location behind the rear axle is all that is feasible, a protective impact deflection structure may have to be provided whether or not a bumper is provided. An investigation whether to relocate the fuel tank or to provide impact deflecting structures is presently underway.

Fill Neck And Cap

All trucks and vans have side fill. The sweptline pickup truck (DW 1-3) and multi-purpose vehicles (AD-1 & AW-1) will have a recessed fill cap and fuel filler door beginning in 1981.

L. L. Baker

ATTACHMENT 6

Mr. David L. Strickland
Administrator
NHTSA Headquarters
1200 New Jersey Avenue, SE
Washington, DC 20590
202-366-4000

1 January 2013

Subject: Chrysler Group, LLC Failure-to-Warn/Comply under 49 CFR § 573.6, et al.

Reference 1: Toyota Motor Corporation/NHTSA Recall 12V-305

Reference 2: EA12-005 File Update (Chrysler Jeep Fuel Tank System Safety Defect)

Four Pages:

One page: Eyewitness report of 28 February 2007 that recounts the final moment that led to the fire-death of Mrs. Susan Kline in a Jeep Grand Cherokee, previously forwarded to NHTSA on 2 September 2012:

“The back of the Jeep immediately burst into flames upon impact. I drove through the debris and the fireball caused by the Jeep exploding.”

Three pages: Photographs of Mrs. Susan Kline.



NEW JERSEY STATE POLICE VOLUNTARY STATEMENT



Case # B080200700445A

Page 1 of 1

Redacted

I was driving down 287 S when I noted 2 vehicles, a Jeep and a Subaru, stopped in the right hand lane \approx 600-800 ft in front of me. There was a Toyota mini van traveling in the right hand lane \approx 100 ft in front of me. I slowed down and started to move out into the left lane. I witnessed the mini van run into the back of the Jeep. The driver of the mini van never put on their brakes or made any evasive maneuver. → The back of the Jeep immediately burst into flames upon impact. I drove through the debris and the fireball caused by the Jeep exploding.

DATE & TIME: 2/28/07 1330

SIGNATURE: [Signature]

WITNESS: Tpr. M. [Signature] # 6771

Mrs. Susan Kline with her family.

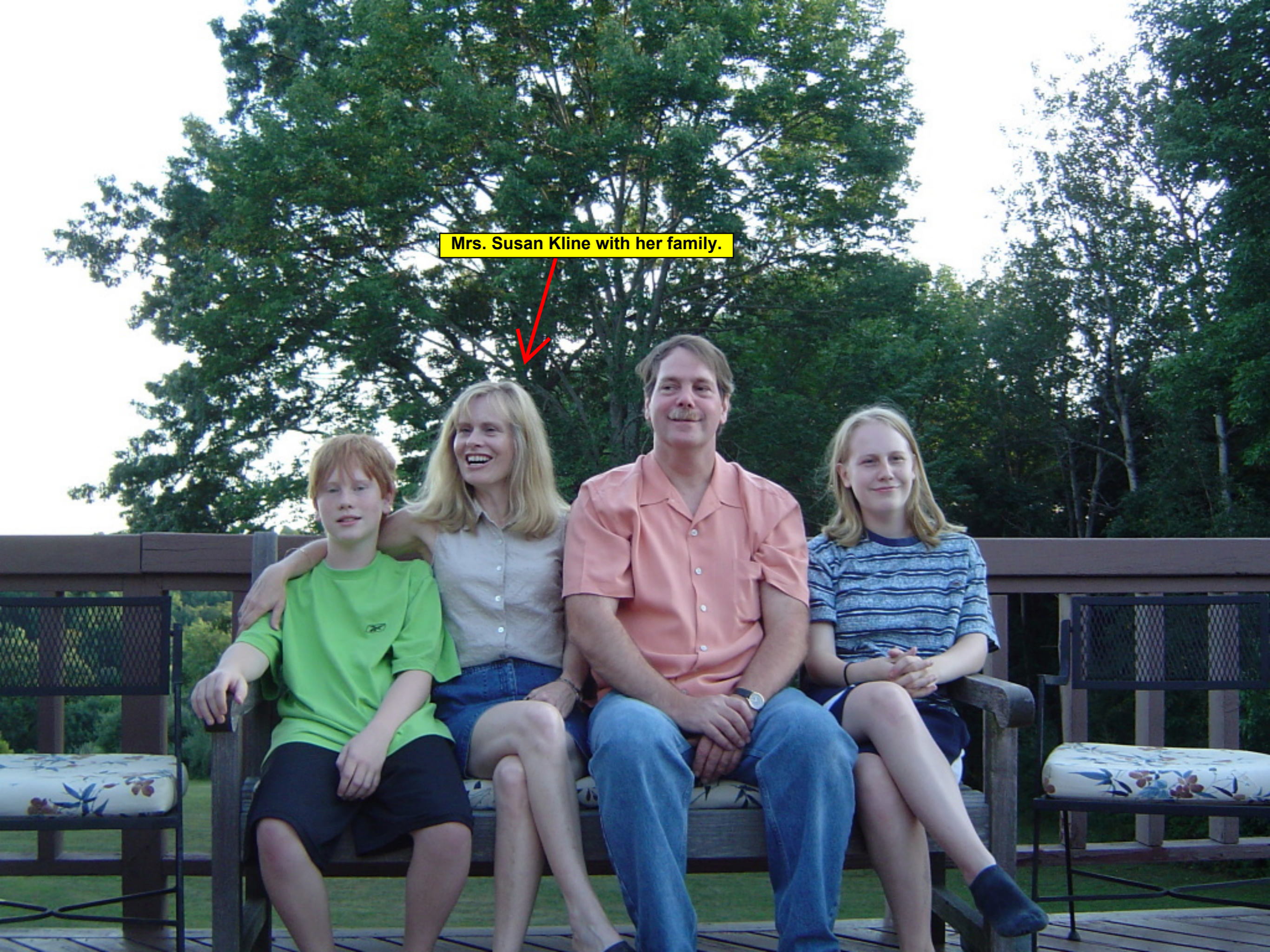



Skull

Lower Edge
of Jaw Bone

Mrs. Susan Kline (death victim):
Post fuel fed fire-death caused by defective fuel system/
tank design in Jeep Grand Cherokee SUVs

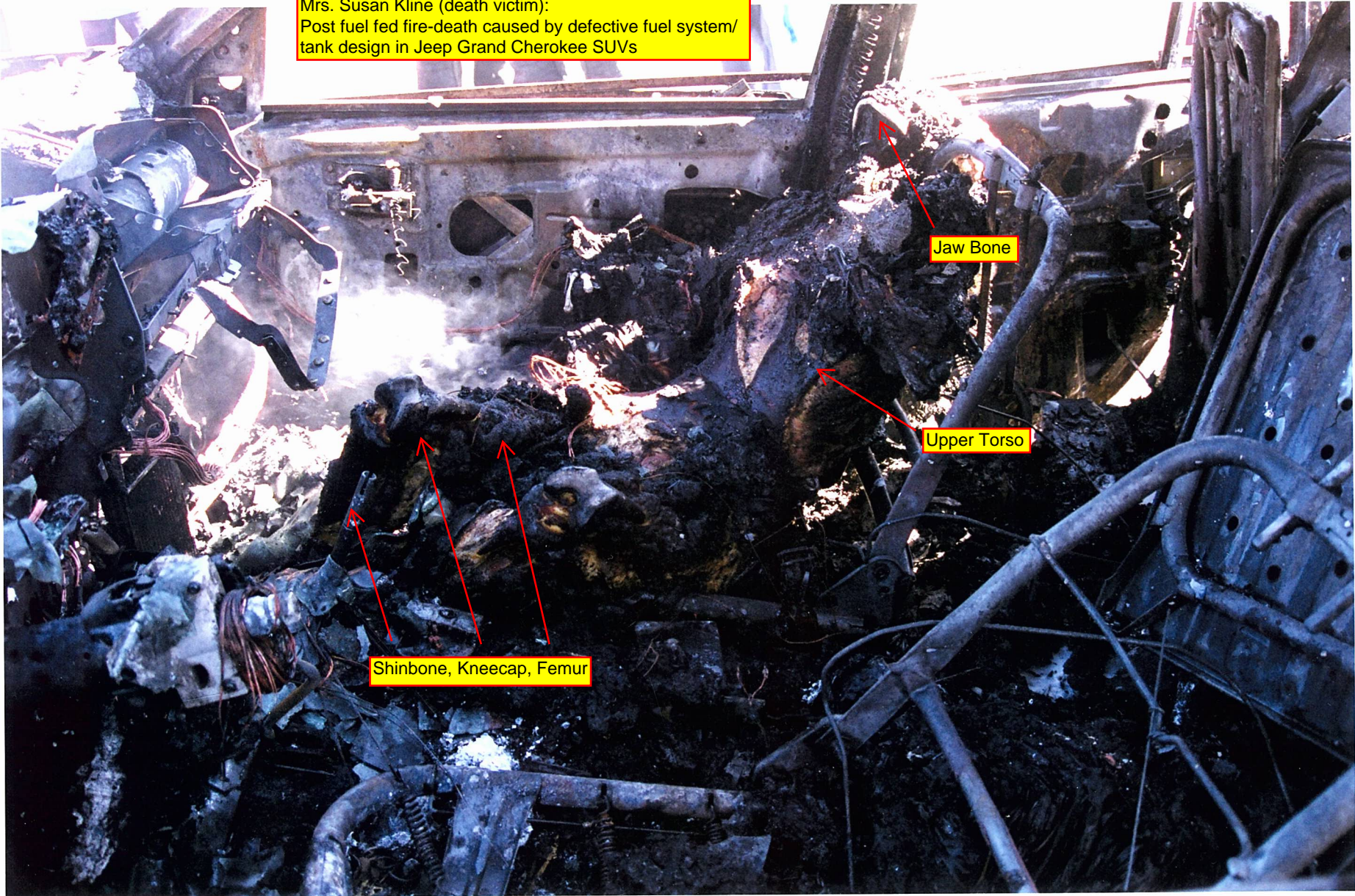

Jaw Bone

Upper Torso

Shinbone, Kneecap, Femur

ATTACHMENT 7

Mr. David L. Strickland
Administrator
NHTSA Headquarters
1200 New Jersey Avenue, SE
Washington, DC 20590
202-366-4000

1 January 2013

Subject: Chrysler Group, LLC Failure-to-Warn/Comply under 49 CFR § 573.6, et al.

Reference 1: Toyota Motor Corporation/NHTSA Recall 12V-305

Reference 2: EA12-005 File Update (Chrysler Jeep Fuel Tank System Safety Defect)

One Page:

NHTSA press release of 18 December 2012 for Toyota Recall 12V-305;
Statement by NHTSA Administrator Mr. David Strickland:

*“It is critical to the safety of the driving public that manufacturers report safety defects in a timely manner. Every **moment** of delay has the potential to lead to deaths or injuries on our nation’s highways.”*



Print

NHTSA 49-12

Tuesday, December 18, 2012

Contact: Karen Aldana, 202-366-9550

Additional Resources

[NHTSA/Toyota Signed Agreement](#)

WASHINGTON - The U.S. Department of Transportation's National Highway Traffic Safety Administration (NHTSA) today announced that Toyota Motor Corporation has agreed to pay \$17.35 million, **the maximum fine allowable under the law,** in response to the agency's assertion that the automaker failed to report a safety defect to the federal government in a timely manner. This action represents the single highest civil penalty amount ever paid to NHTSA for violations stemming from a recall.

"Safety is our highest priority," said U.S. Transportation Secretary Ray LaHood. "With today's announcement, I expect Toyota to rigorously reinforce its commitment to adhering to United States safety regulations."

Federal law requires all auto manufacturers to notify NHTSA within five business days of determining that a safety defect exists or that the vehicle is not in compliance with federal motor vehicle safety standards and to promptly conduct a recall.

"It's critical to the safety of the driving public that manufacturers report safety defects in a timely manner," said NHTSA Administrator David Strickland. **"Every moment of delay has the potential to lead to deaths or injuries on our nation's highways."**

In early 2012, NHTSA's Office of Defects Investigation began noticing a trend in floor mat pedal entrapment in 2010 Lexus RX 350s in Vehicle Owner Questionnaires (VOQs) and Early Warning Reporting data. In May, NHTSA contacted Toyota regarding the trend, and a month later Toyota advised NHTSA that it was aware of 63 alleged incidents of **possible** floor mat pedal entrapment in Model Year 2010 Lexus RX 350s since 2009. Toyota's own technicians and dealer technicians reported that certain alleged incidents of unwanted acceleration had been caused by floor mat pedal entrapment.

In June, Toyota advised NHTSA that it would conduct a recall of 154,036 Model Year 2010 Lexus RX 350 and Model Year 2010 RX 450h vehicles to address floor mat pedal entrapment.

As part of today's settlement, Toyota Motor Corporation and its U.S. based subsidiaries agreed to make internal changes to their quality assurance and review of safety-related issues in the United States, and to improve their ability to take into account the possible consequences of potential safety-related defects.

The last time Toyota faced civil penalties was in 2010 when the automaker agreed to pay \$48.8 million as a result of three separate investigations into the automaker's handling of auto recalls. The automaker paid maximum civil penalties for violations stemming from the pedal entrapment, sticky pedal and steering relay rod recalls.



END OF DOCUMENT

Mr. David L. Strickland
Administrator
NHTSA Headquarters
1200 New Jersey Avenue, SE
Washington, DC 20590
202-366-4000

1 January 2013

Subject: Chrysler Group, LLC Failure-to-Warn/Comply under 49 CFR § 573.6, et al.

Reference 1: Toyota Motor Corporation/NHTSA Recall 12V-305

Reference 2: EA12-005 File Update (Chrysler Jeep Fuel Tank System Safety Defect)
